



# Benodict

SURGICAL INSTRUMENTS











SURGICAL INSTRUMENTS CATALOGUE



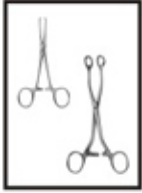

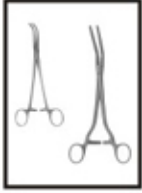
# Table Of Contents









	Page Seite		Page Seite	
Diagnostic, Anaesthesia and other instruments	1 - 10		Probes, Pocket Instruments sets	66 - 68
Scalpels, knives and Scalpel Handles	11 - 14		Wound Retractors	69 - 80
Scissors	15 - 31		Self-Retaining Retractors, Abdominal Retractors	81 - 85
Dissecting-and Tissue Forceps	32 - 42		Abdominal Surgery Intestinal-and Rectal Instruments	86 - 93
Sponge, Dressing and Tissue Grasping Forceps Towel Clamps	43 - 48		Gall Bladder-, Liver-and Spleen Instruments	94 - 96
Vessel Clips, Bulldog Clamps Haemostatic Forceps	49 - 57		Genito-Urinary Instruments and Trocars	97 - 100
Ligature, Hysterectomy and Compression Forceps Vaginal Clamps	58 - 60		Vaginal Specula and Uterine Dilators	101 - 106
Needle Holders, Suture Instruments	61 - 65		Uterine Probes, Uterine Dressing-, Polypus-and Ovum Forceps	107 - 109







# Table Of Contents

	Page Seite		Page Seite
Biopsy Instruments and Curettes	110 - 116		Suction Instruments 158 - 166
Obstetrics and Tracheotomy	117 - 119		Hospital Wares 167 - 174
Cardiovascular-and Thoracic Surgery	120 - 128		TC Instruments 175 - 187
Bone Punches, Rongeurs	129 - 134		
Elevators, Bone Levers, Raspatories, Bone Files, Bone Curettes	135 - 139		
Mallets, Chisels and Gouges	140 - 141		
Bone Holding Forceps, Bone Rongeurs, Bone Cutting Forceps	142 - 146		
Plaster Instruments	147 - 157		





## Percussion Hammers and Aesthesiometers





**Stethoscopes**



**01-110**  
PINARD (Aluminum)  
Size: 155 mm

½



**01-111**  
wooden  
Size: 145 mm

½



**01-112**  
BOWLES  
Stethoscope  
with diaphragm

¼



**01-113**  
ANESTOPHON

½



**01-114**  
FORD-BOWLES  
Dual chest piece  
with two outlets

¼



**01-115**  
BOWLES

¼

## Head Mirrors and Head Bands

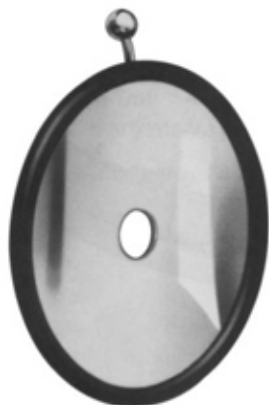

**01-116**  
ZIEGLER  $\varnothing$  90mm  
head mirror only  
with rubber coating

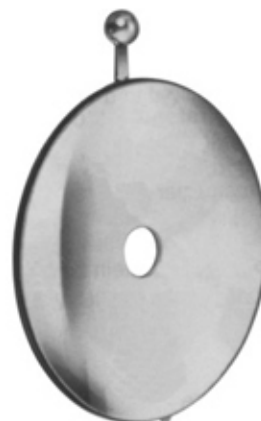

**01-117**  
ZIEGLER  $\varnothing$  90mm  
head mirror only  
with metal coating



**01-118**  
ZIEGLER  
head band of plastic black

**01-119**  
ZIEGLER  
head band of plastic white

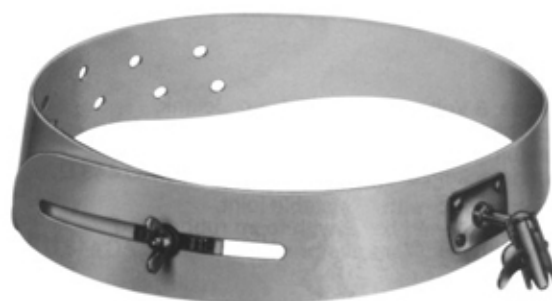

**01-120**  
MURPHY  
head band of celluloid, white

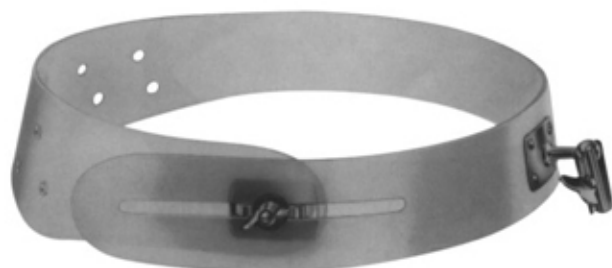

**01-121**  
head band of plastic,  
white, soft pattern



**01-122**  
head mirror with black  
plastic head band.



# Tongue Depressors

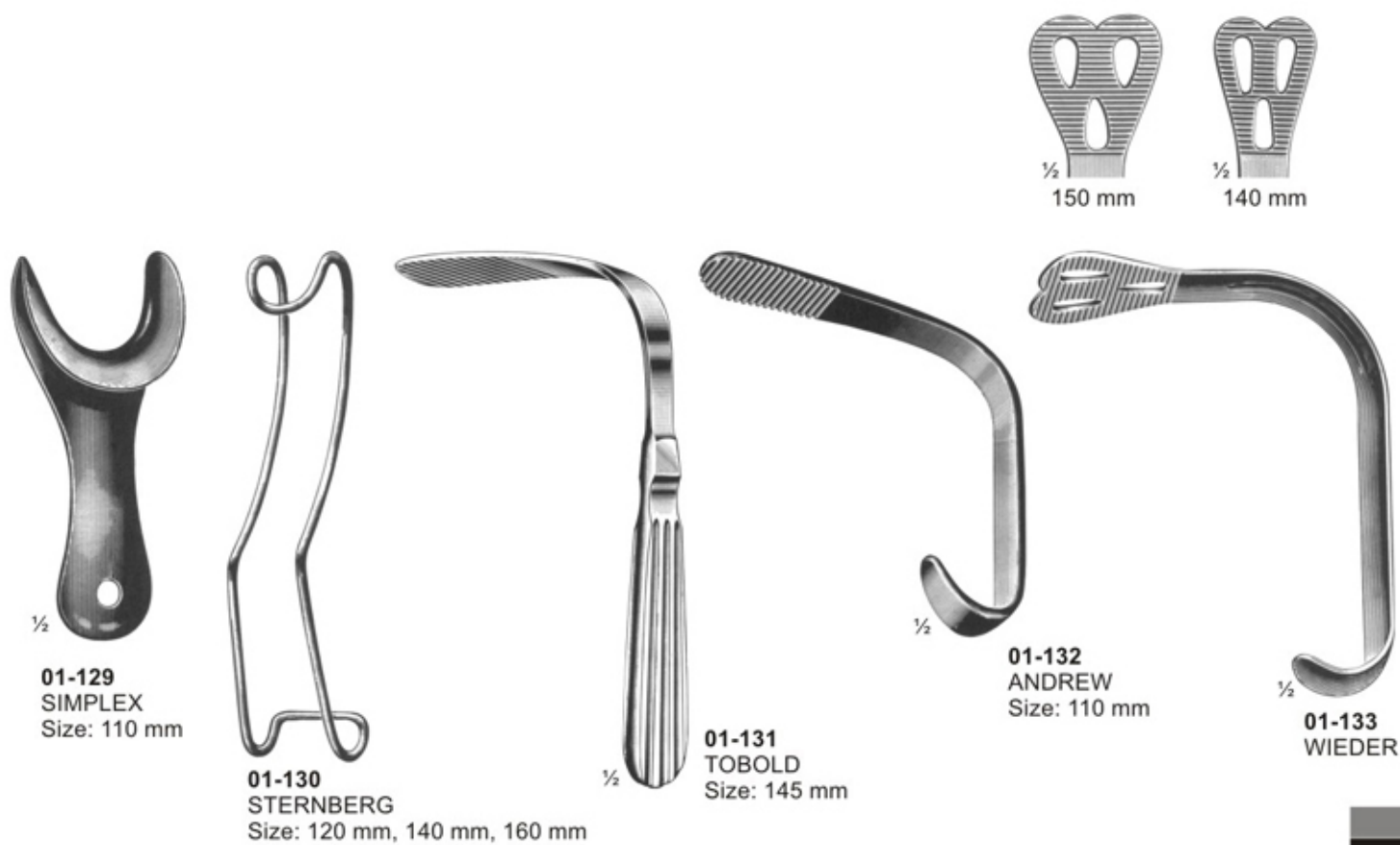
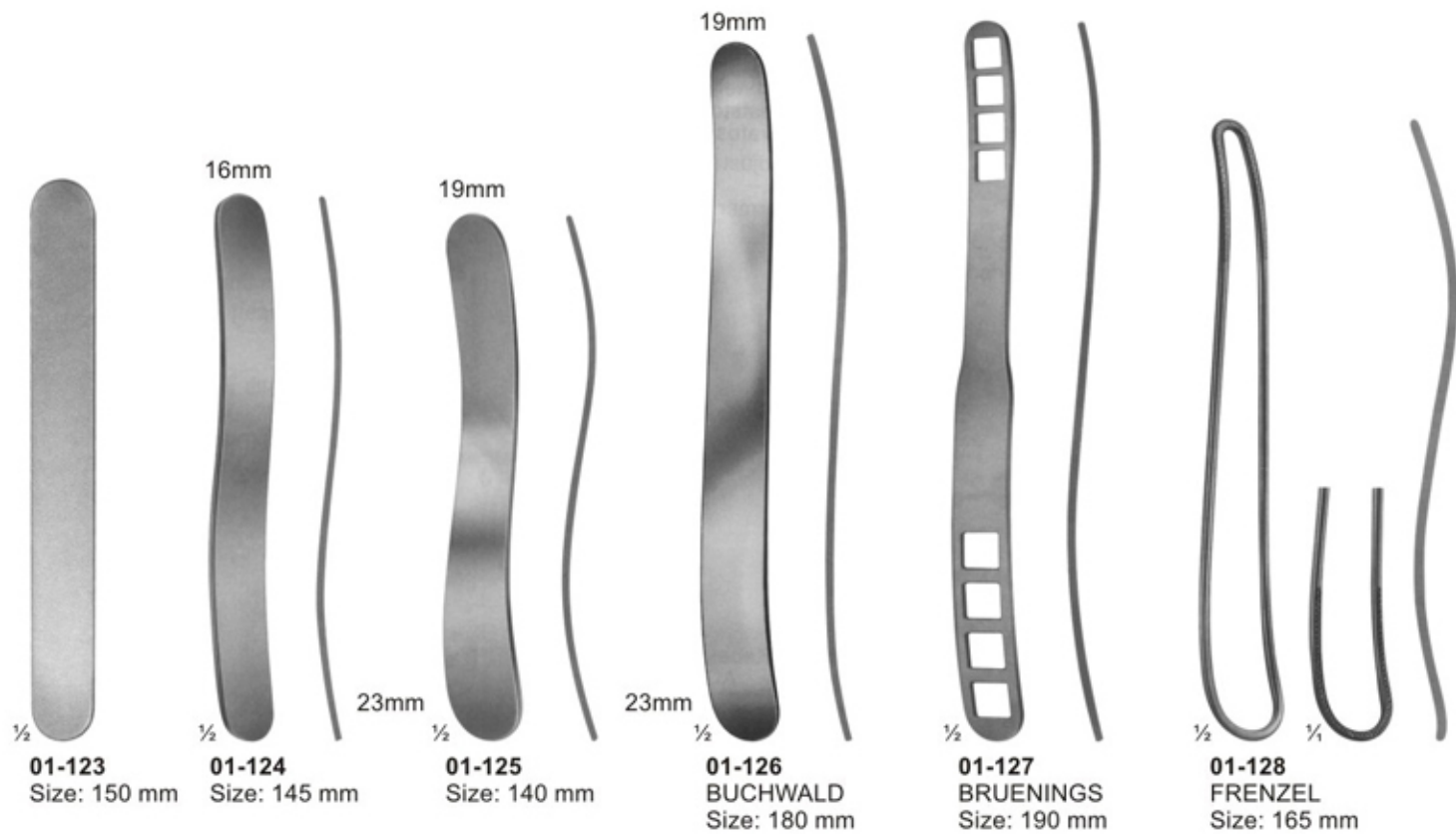

## Instruments for Anaesthesia and Tongue Forceps



**01-134**  
**SCHIMMELBUSCH**  
Ether mask



**01-135**  
**HEISTER**  
Mouth gag  
Size: 130 mm



**01-136**  
**FERGUSSON-ACKLAND**  
Mouth gag  
Size: 145 mm



**01-137**  
**DENHARDT**  
Mouth gag with silicon  
inserts, interchangeable  
Size: 125 mm



**01-138**  
**ROSER KOENIG**  
Mouth gag  
Size: 160 mm, 185 mm

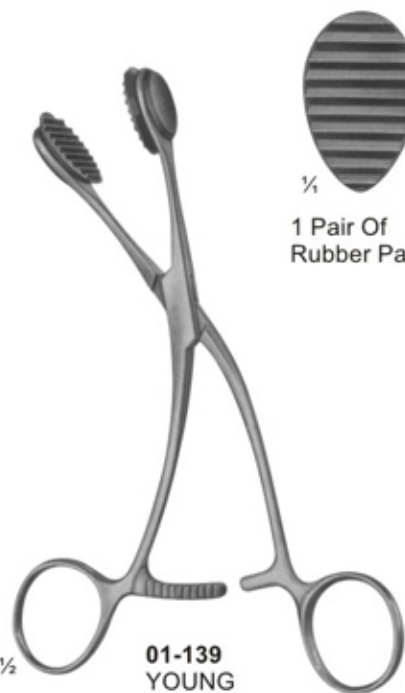

**01-139**  
**YOUNG**  
Size: 165 mm



1 Pair Of  
Rubber Pads

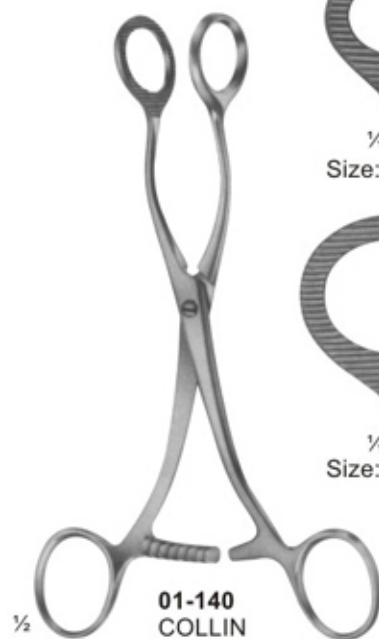

**01-140**  
**COLLIN**  
Size: 160 mm,  
170 mm



Size: 160 mm



Size: 170 mm

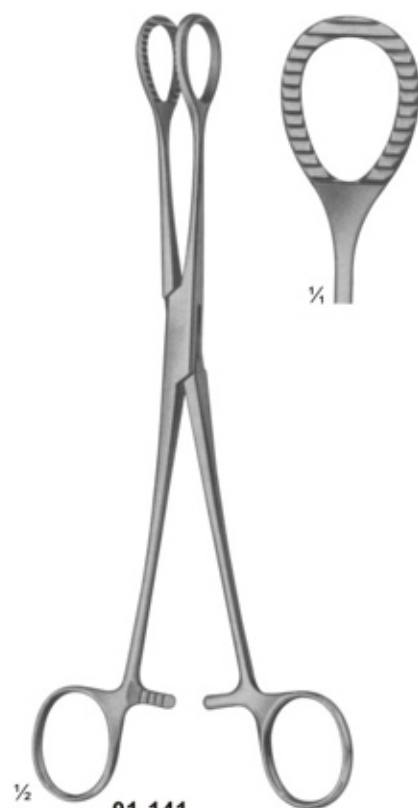

**01-141**  
**HEYWOOD-SMITH**  
modif. Size: 215 mm





# Blood Lancets and Laryngeal Mirrors

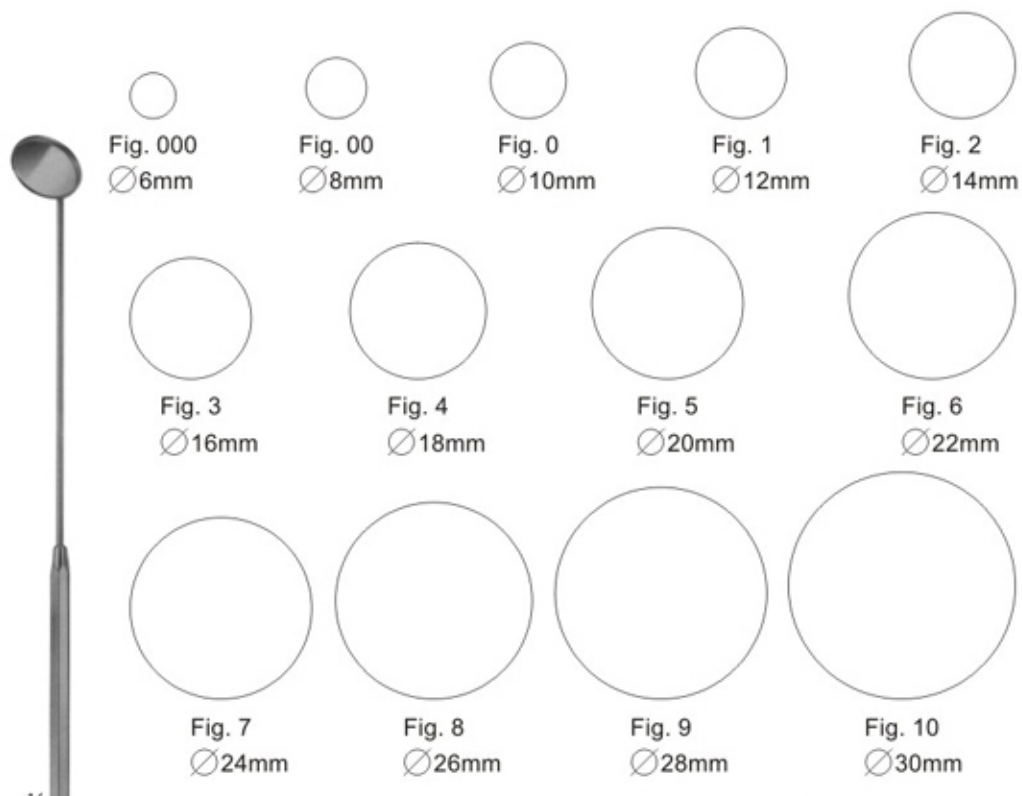

**01-142**  
FRANCKE  
Automatic blood lancet



**01-143**  
Laryngeal mirrors with  
hexagonal handle  
Size: 180 mm

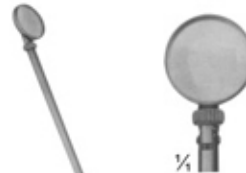

**01-148**  
Spare mirrors only  
Size: 12 mm



**01-149**  
Spare mirrors only  
Size: 14 mm



**01-144**  
KOLLE  
Microscopic Needle  
Holder with plastic  
handle.  
Size: 240 mm



**01-145**  
Mirror handle  
Size: 110 mm



**01-146**  
Mirror handle  
Size: 105 mm



**01-147**  
MICHEL  
Rhinoscopic mirrors with  
interchangeable mirror inserts  
Size: 250 mm

**Retractors**

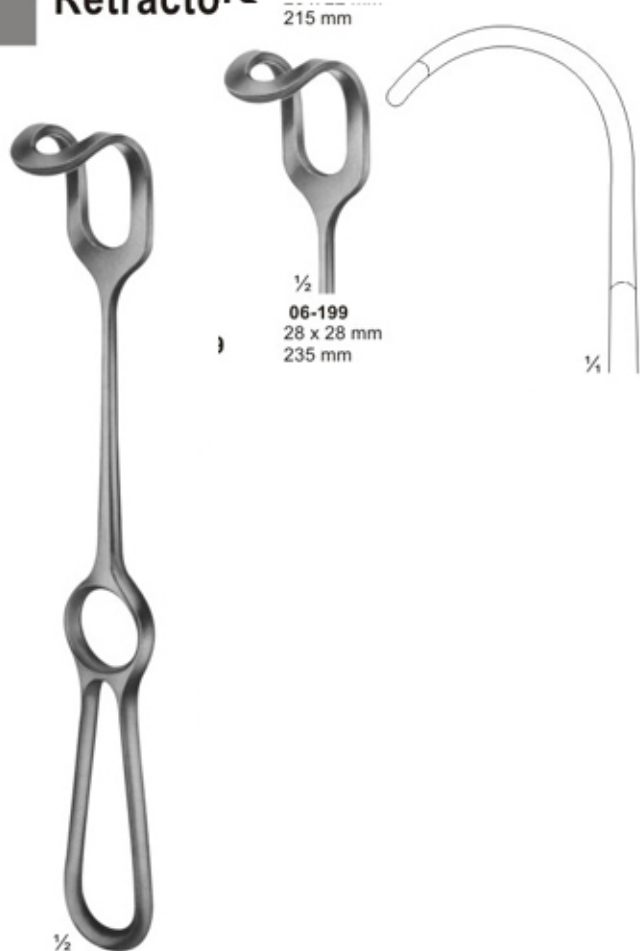



# Laryngoscope and Diagnostic Sets



$\frac{1}{4}$   
**01-150**  
Infants  
Size: 150 mm

$\frac{1}{4}$   
**01-151**  
Children  
Size: 200 mm

$\frac{1}{4}$   
**01-152**  
Adults  
Size: 250 mm

**01-154**

$\frac{1}{2}$   
**01-150 - 152**  
MAGILL

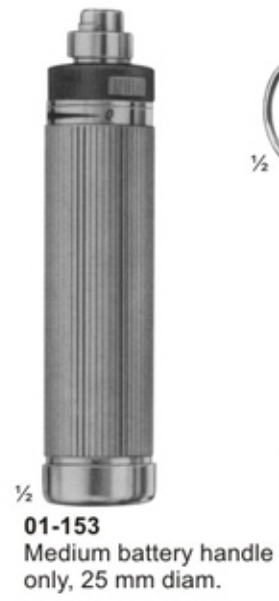

$\frac{1}{2}$   
**01-153**  
Medium battery handle  
only, 25 mm diam.



**01-153-A**  
Spare bulb  
2.7 volt, for  
otoscopes



**01-153-B**  
Spare bulb  
2.6 volt, for  
ophthalmoscopes



**01-155**



**01-156**  
Otoscope set, consists of  
battery handle without batteries,  
3 ear specula, 1 bulb in valvet lined case



**01-157**  
Diagnostic set, otoscope with three specula,  
nasal speculam, lamp holder, two laryngeal  
mirrors, tongue blade holder

# Laryngoscopes



**01-158**  
**MILLER**  
 Laryngoscope set, consists of battery handle ( without battery )  
 with four miller laryngoscope blades

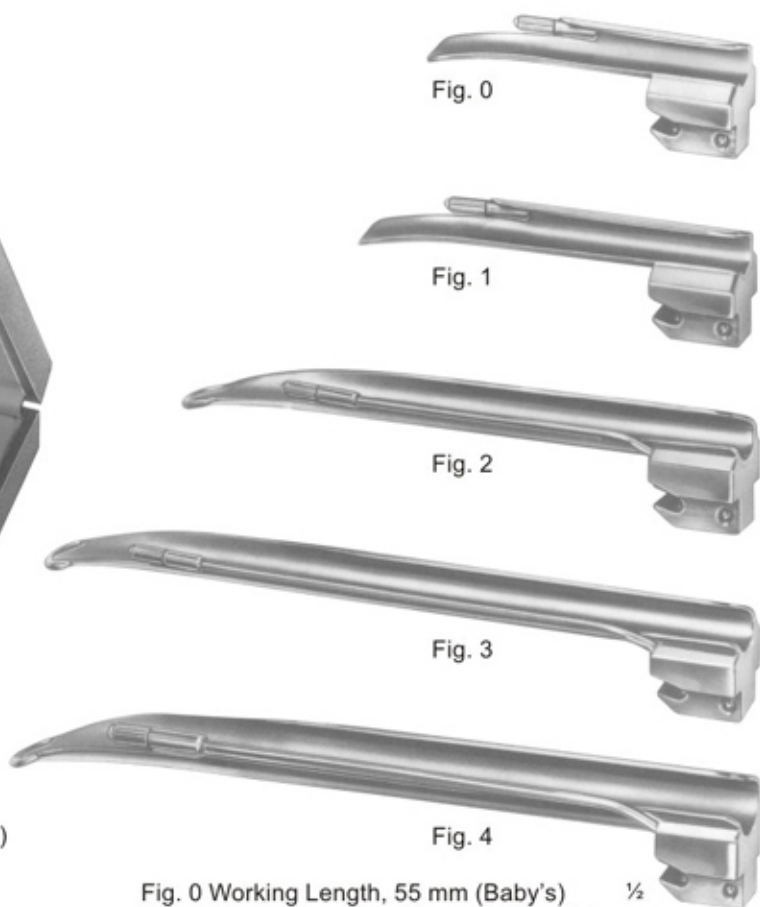

Fig. 0 Working Length, 55 mm (Baby's)  
 Fig. 1 Working Length, 80 mm (Children's)  
 Fig. 2 Working Length, 130 mm (Adolescent's)  
 Fig. 3 Working Length, 170 mm (Women's)  
 Fig. 4 Working Length, 180 mm (Men's)



**01-159**  
**GUEDEL-NEGUS**  
 Laryngoscope set, consists of battery handle ( without battery )  
 with four miller laryngoscope blades



Fig. 1 Working Length, 70 mm (Children's)  
 Fig. 2 Working Length, 90 mm (Adolescent's)  
 Fig. 3 Working Length, 110 mm (Women's)  
 Fig. 4 Working Length, 135 mm (Men's)



# Gall Stone Forceps

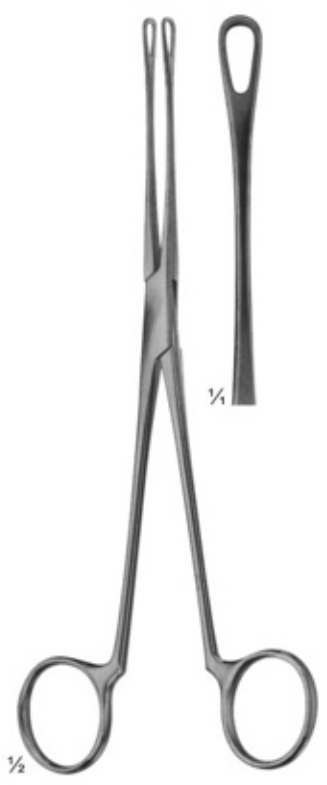

**08-171**  
BLAKE  
205 mm

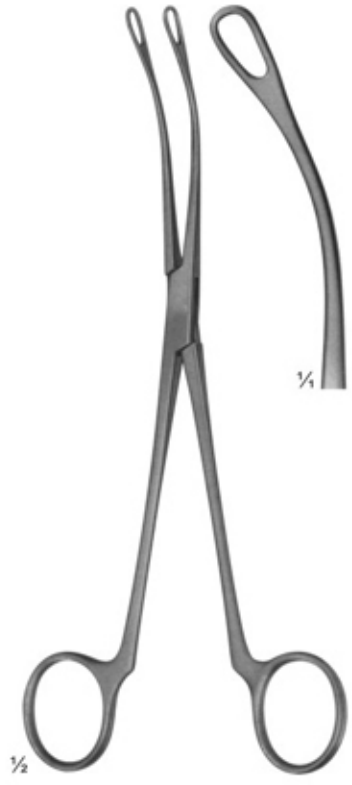

**08-172**  
BLAKE  
205 mm

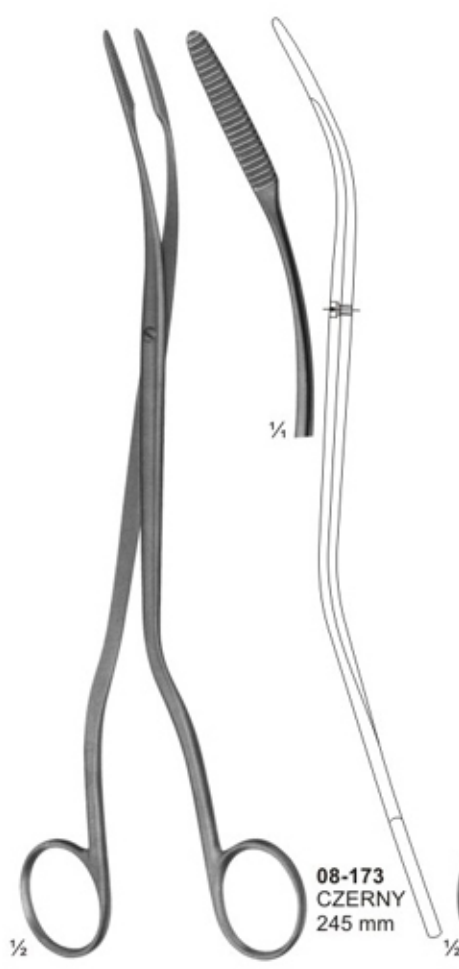

**08-173**  
CZERNY  
245 mm

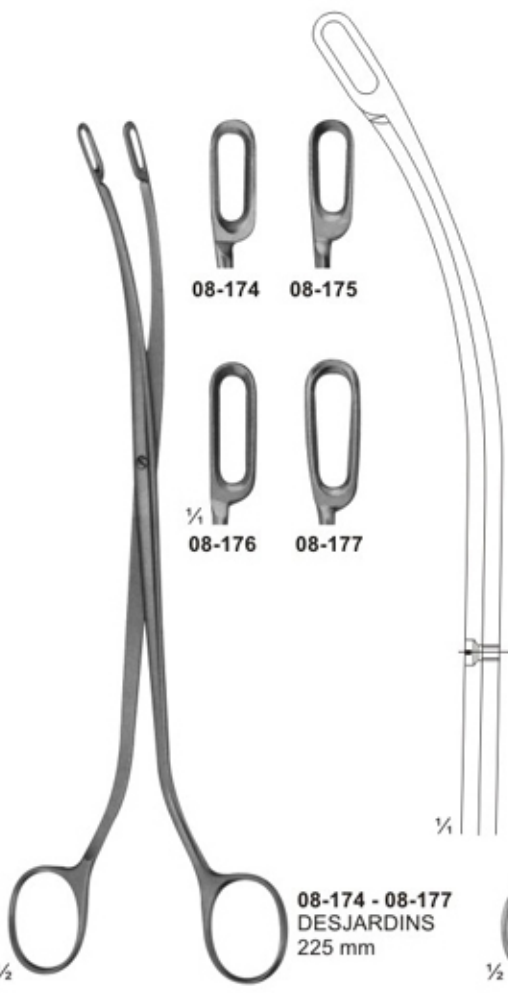

**08-174 - 08-177**  
DESJARDINS  
225 mm

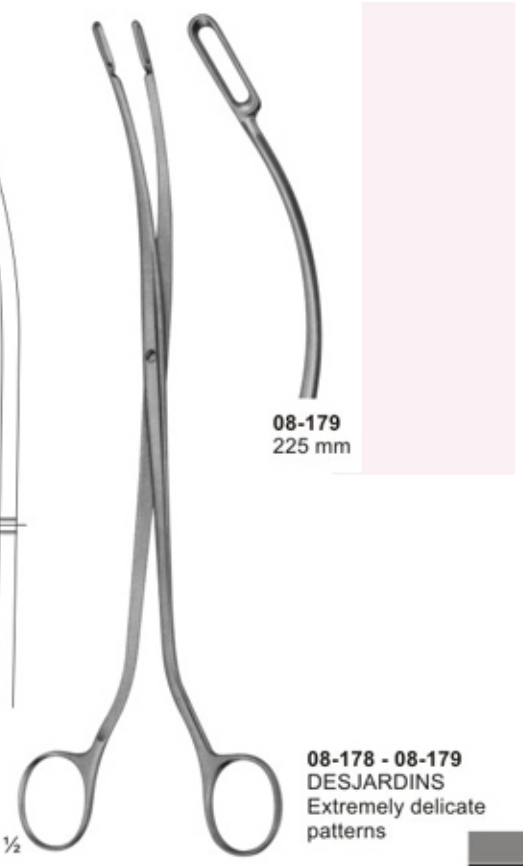

**08-178 - 08-179**  
DESJARDINS  
Extremely delicate  
patterns

# Laryngoscopes



1/3

**01-160**  
McINTOSH  
Laryngoscope Set, Consists Of Battery Handle ( Without Battery )  
With Three McIntosh Blades, Fig. 1, Fig. 2, Fig. 3

**01-161**  
McINTOSH  
Laryngoscope Set, Consists Of Battery Handle ( Without Battery )  
With Five McIntosh Blades, Fig. 0, Fig. 1, Fig. 2, Fig. 3, Fig. 4



Fig. 0



Fig. 1



Fig. 2



Fig. 3



Fig. 4

1/2

01-161 A Fig. 0 Working Length, 55 mm (Baby's)  
01-161 B Fig. 1 Working Length, 75 mm (Children's)  
01-161 C Fig. 2 Working Length, 90 mm (Adolescent's)  
01-161 D Fig. 3 Working Length, 110 mm (Women's)  
01-161 E Fig. 4 Working Length, 135 mm (Men's)

**01-162**  
FOREGGER  
Laryngoscope Set, Consists Of  
Battery Handle ( Without Battery )  
With Three Foregger Blades,  
Fig. 1, Fig. 2, Fig. 3,



1/3

**01-163**  
FOREGGER  
Laryngoscope Set, Consists Of  
Battery Handle ( Without Battery )  
With Four Foregger Blades,  
Fig. 1, Fig. 2, Fig. 3, Fig. 4,



Fig. 1



Fig. 2



Fig. 3



Fig. 4

1/2

01-162 A Fig. 1 Working Length, 70 mm (Children's)  
01-162 B Fig. 2 Working Length, 90 mm (Adolescent's)  
01-162 C Fig. 3 Working Length, 110 mm (Women's)  
01-162 D Fig. 4 Working Length, 135 mm (Men's)



**01-164**  
Fiber Optic  
Battery Handle  
30mm diam.



**01-165**  
Fiber Optic  
Battery Handle  
18mm diam.



**01-166**  
Replacement Lamp  
( Krypton ) 2.5 V



**01-167**  
Replacement Lamp  
( Halogen ) 2.5 V





# Examination & Measuring Instruments

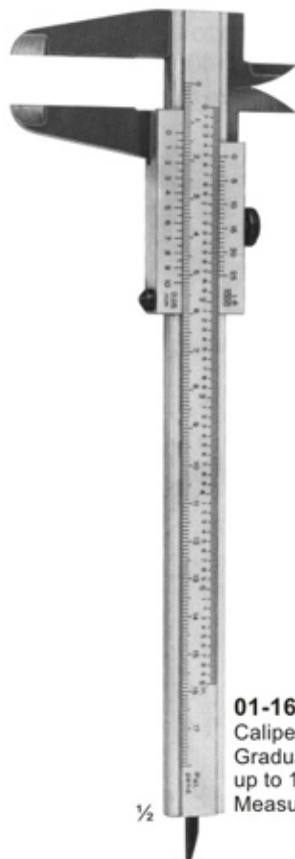

**01-168**  
Caliper Of Aluminium  
Graduated in mm & inches  
up to 180mm  
Measuring Range up to 139mm



**01-169**  
VERNIER  
Universal Caliper Of Steel  
Graduated in mm & inches  
up to 180mm  
Measuring Range up to 120mm  
with Vernier in 1/10mm & 1/16"



**01-170**  
CARROLL  
Size: 145 mm  
Finger Goniometer



**01-171**  
TOWNLEY  
Graduated in  
mm & inches  
Size: 115 mm



**01-172**  
COLLIN  
Druck Pressure 72 kg  
Size: 125 mm



**01-173**  
BERTILLON  
Caliper For Measuring The Head  
Size: 320 mm



**01-174**  
CASTROVIEJO  
Caliper  
Size: 75mm



**01-175**  
MOLTGEN  
Goniometer

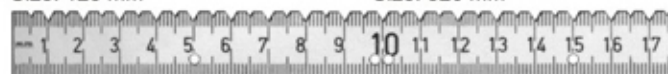

**01-176**  
Size: 150 mm



**01-177**  
Size: 500 mm



# Dissecting Knives



$\frac{1}{2}$   
**02-101 - 110**  
Fig. 1 - 10



$\frac{1}{4}$   
**02-101**  
Fig. 1  
30 mm



**02-102**  
Fig. 2  
36 mm



**02-103**  
Fig. 3  
40 mm



**02-104**  
Fig. 4  
45 mm



**02-105**  
Fig. 5  
50 mm



$\frac{1}{4}$   
**02-106**  
Fig. 6  
27 mm



**02-107**  
Fig. 7  
35 mm



**02-108**  
Fig. 8  
40 mm



**02-109**  
Fig. 9  
47 mm



**02-110**  
Fig. 10  
50 mm



# Amputating Knives, Cartilage Knives and Autopsy Knives



**LISTON**  
**02-111**  
Size: 130 mm  
**02-112**  
Size: 160 mm  
**02-113**  
Size: 190 mm  
**02-114**  
Size: 200 mm

**02-115**  
**CATLIN**  
Size: 160 mm  
Blade length  
Amputating  
Knives

**02-116**  
**LANGENBECK**  
Size: 120 mm  
Blade length  
Flap Knives

**02-117**  
Size: 110 mm  
Blade length  
Interosseous  
Knives

**02-118**  
Size: 55 mm  
Blade length  
with raspatory,  
Wooden handle

**02-119**  
Size: 70 mm  
Blade length  
Wooden handle

**02-120**  
Size: 80 mm  
Blade length  
Metal handle

**02-121**  
Size: 195 mm  
Blade length  
Metal handle

Blade length  
Amputating Knives



**Benodict**  
SURGICAL INSTRUMENTS

# Cone Knives, Myomatome, Trigeminal and Tonsil Knives



**02-122**  
AYRE  
Size: 235 mm  
Cone Knife

**02-123**  
Size: 230 mm  
Cone Knife

**02-124**  
SEGOND  
Size: 270 mm  
Myomatome

**02-125**  
OLIVECRONA  
Size: 205 mm  
Trigeminal  
Knife

**02-126**  
Size: 230 mm  
Trigeminal  
Knife

**02-127**  
FOWLER  
Size: 200 mm  
Tonsil Knife

**02-128**  
ABRAHAM  
Size: 215 mm  
Tonsil Knife

**02-129**  
BRUNINGS  
Size: 215 mm  
Tonsil Knife





**Benodict**  
SURGICAL INSTRUMENTS

## Scalpel Handles

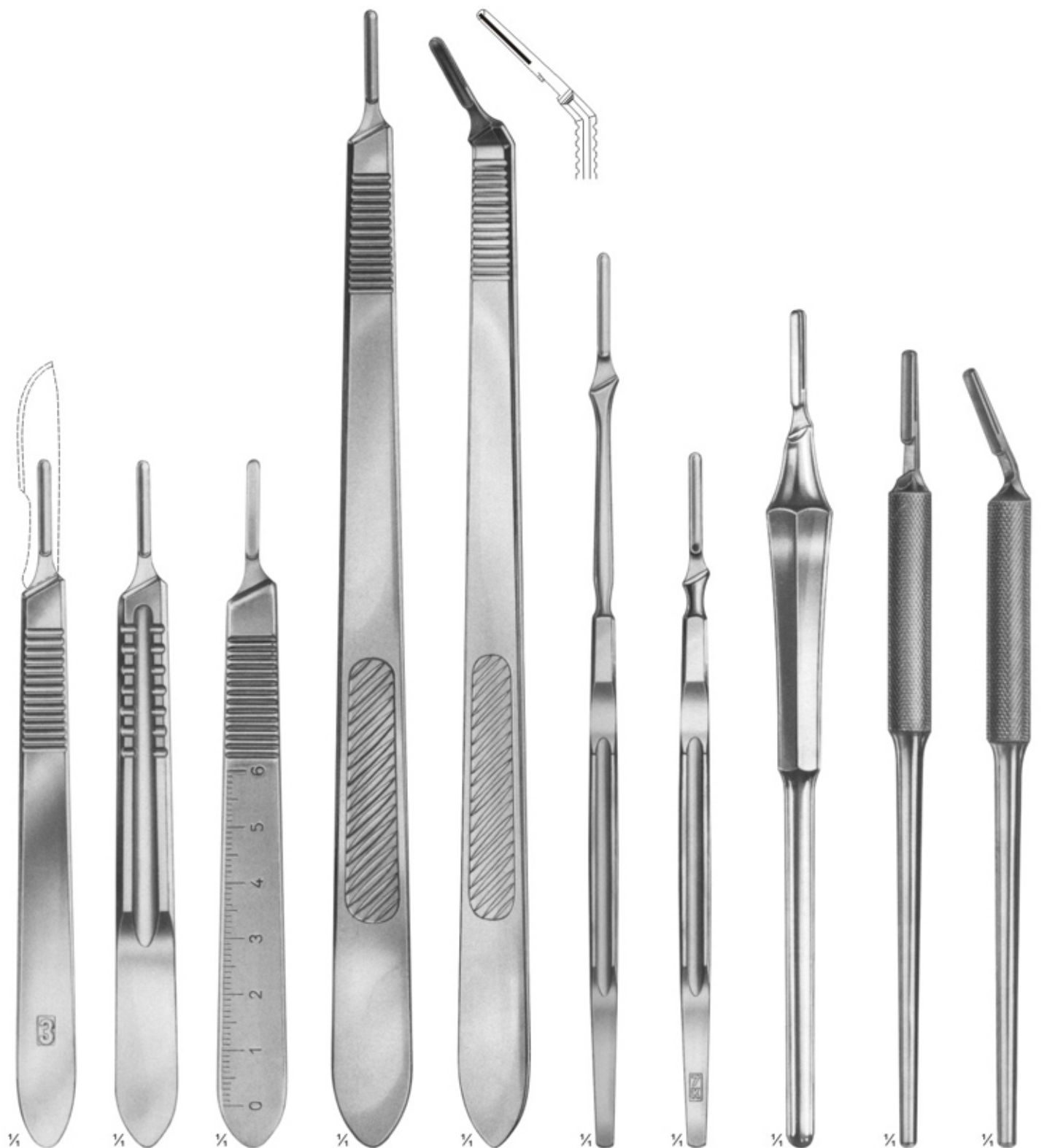

02-130  
STANDARD No. 3  
Solid  
12 cm

02-131  
No. 3  
Solid  
12 cm

02-132  
No. 3  
Solid  
12 cm

02-133  
No. 3 L  
Straight  
Solid  
21.5 cm

02-134  
No. 3 L  
Angled  
Solid  
21 cm

02-135  
No. 7  
Solid  
16 cm

02-136  
No. 7 K  
Solid  
12.5 cm

02-137  
Hollow-Round  
15.5 cm

02-138  
No. 3  
Straight  
Solid,  
Round  
14.5 cm

02-139  
No. 3  
Angled  
Solid,  
Round  
14 cm

## Micro Scissors (Spring Type) with Flat Handles

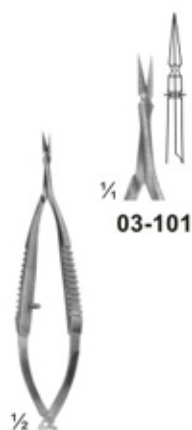

**03-101 - 103**  
VANNAS  
Size: 85 mm

**03-104 - 105**  
CASTROVIEJO  
Size: 95 mm

**03-106**  
NOYES  
Size: 125 mm



**03-107 - 108**  
WECKER  
Eye scissor  
Size: 110 mm

**03-109**  
CASTROVIEJO  
Eye scissor  
Size: 115 mm

**03-110 - 111**  
CASTROVIEJO  
Eye scissor  
Size: 110 mm



# Micro Scissors (Spring Type) with Flat Handles

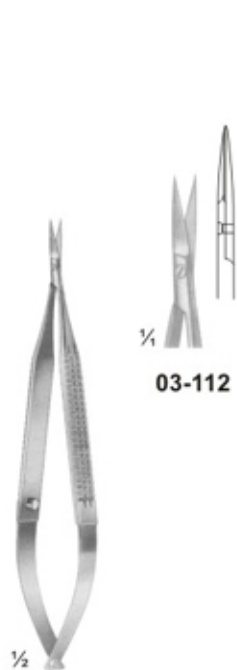

1/4  
**03-112**



**03-113**



1/2  
**03-114**  
BIEMER  
Vein scissor  
Size: 130 mm



1/4  
**03-115**  
Size: 160 mm



1/2  
**03-116 - 117**  
VANNAS  
Size: 160 mm

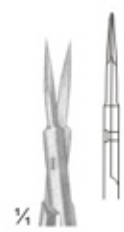

1/4  
**03-116**



1/4  
**03-117**

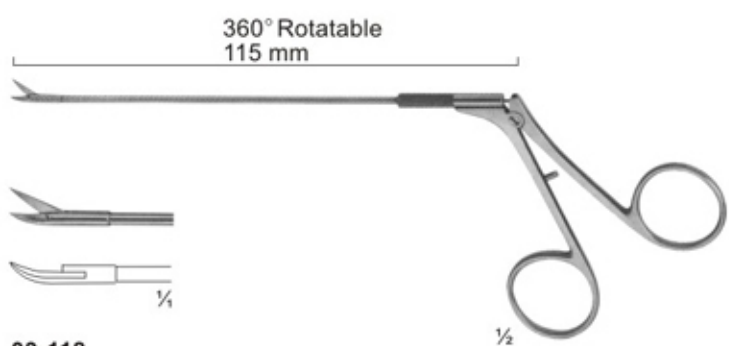

360° Rotatable  
115 mm

**03-118**  
CASPAR  
Micro scissor curved  
Size: 115 mm



1/4  
**03-119**



**03-120**



**03-121**



1/2  
**03-119 - 121**  
Micro dissecting scissor  
Size: 145 mm

## Elevators and Bone Levers

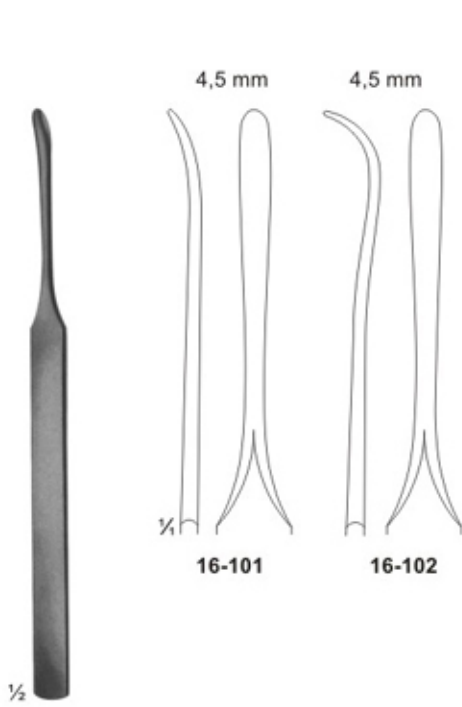

**16-101 - 102**  
KONIG  
155 mm



**16-103**  
WILLIGER  
165 mm

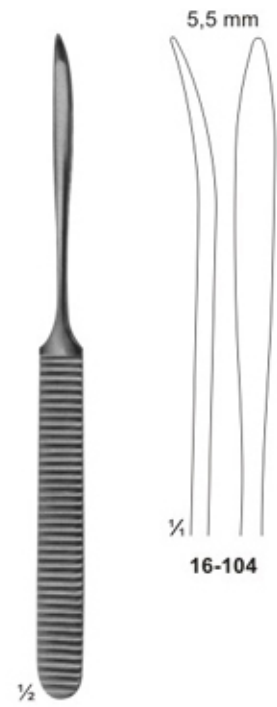

**16-104**  
WILLIGER  
170 mm

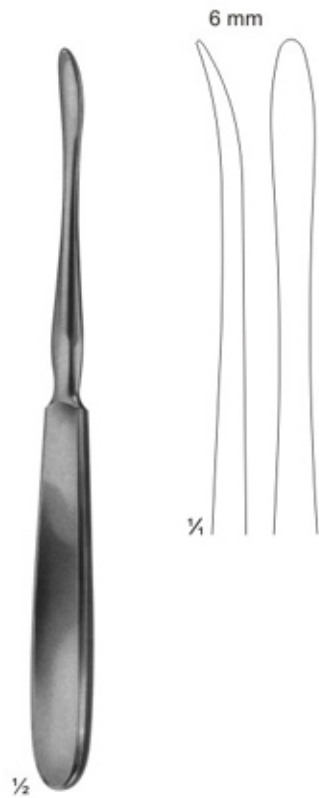

**16-105**  
QUERVAIN  
195 mm



**16-106 - 107**  
LANGENBACK  
195 mm

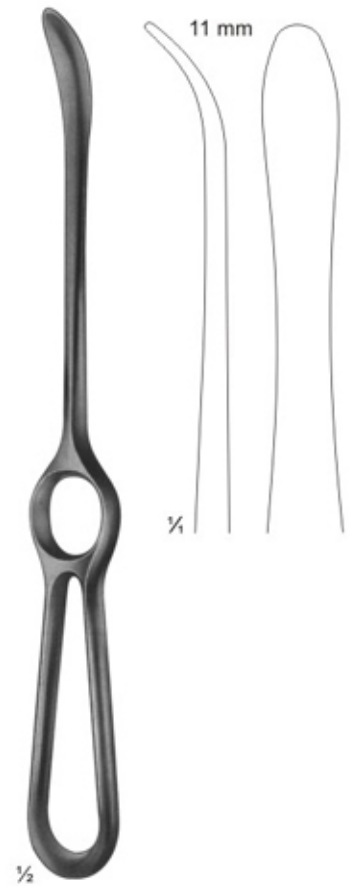

**16-108**  
LANGENBACK  
230mm



## Delicate Scissors



**03-128 - 129**  
Size: 90 mm



**03-130 - 131**  
Size: 95 mm

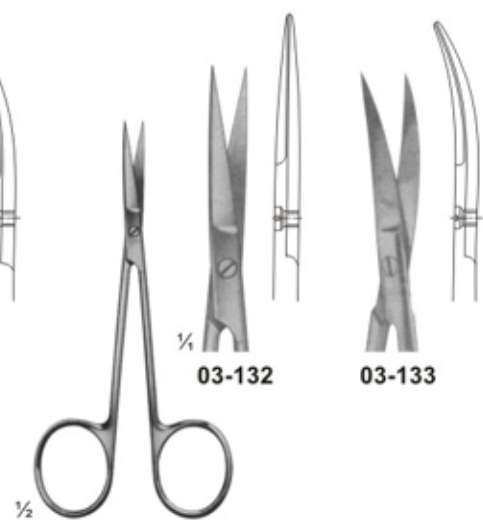

**03-132 - 133**  
Size: 105 mm

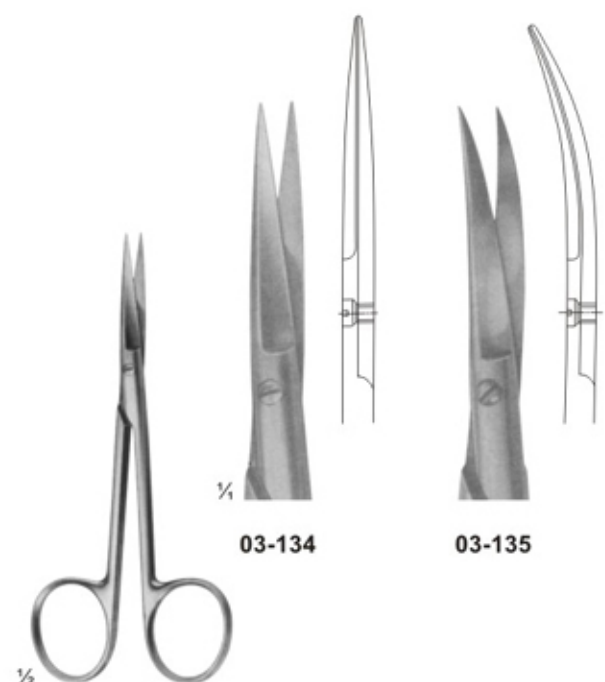

**03-134 - 135**  
Size: 120 mm



**03-136 - 137**  
Size: 115 mm

## Delicate Scissors



**03-138 - 140**  
Size: 120 mm



**03-138**



**03-139**



**03-140**



**03-141 - 144**  
Size: 130 mm

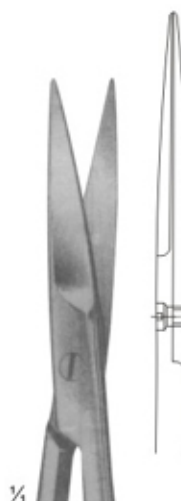

**03-141**



**03-142**



**03-143**



**03-144**



# Surgical Scissors

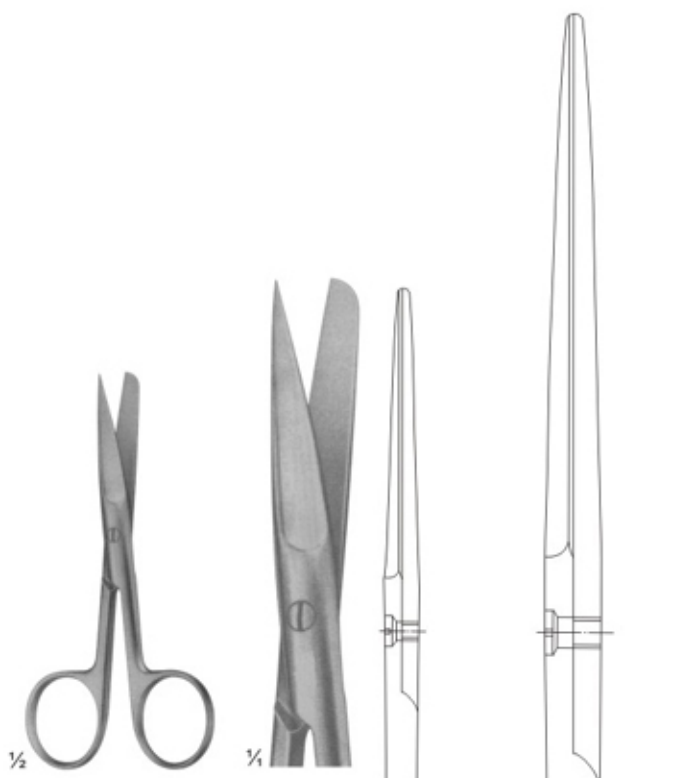

**03-145 - 153 (Standard types)**  
 03-145 ( 105 mm )  
 03-146 ( 115 mm )  
 03-147 ( 130 mm )  
 03-148 ( 145 mm )  
 03-149 ( 150 mm )  
 03-150 ( 165 mm )  
 03-151 ( 175 mm )  
 03-152 ( 185 mm )  
 03-153 ( 200 mm )

**03-145**  
 Size: 105 mm

**03-153**  
 Size: 200 mm



**03-154 - 160 (Standard types)**  
 03-154 ( 115 mm )  
 03-155 ( 130 mm )  
 03-156 ( 145 mm )  
 03-157 ( 150 mm )  
 03-158 ( 165 mm )  
 03-159 ( 175 mm )  
 03-160 ( 185 mm )

**03-154**  
 Size: 115 mm

**03-160**  
 Size: 185 mm

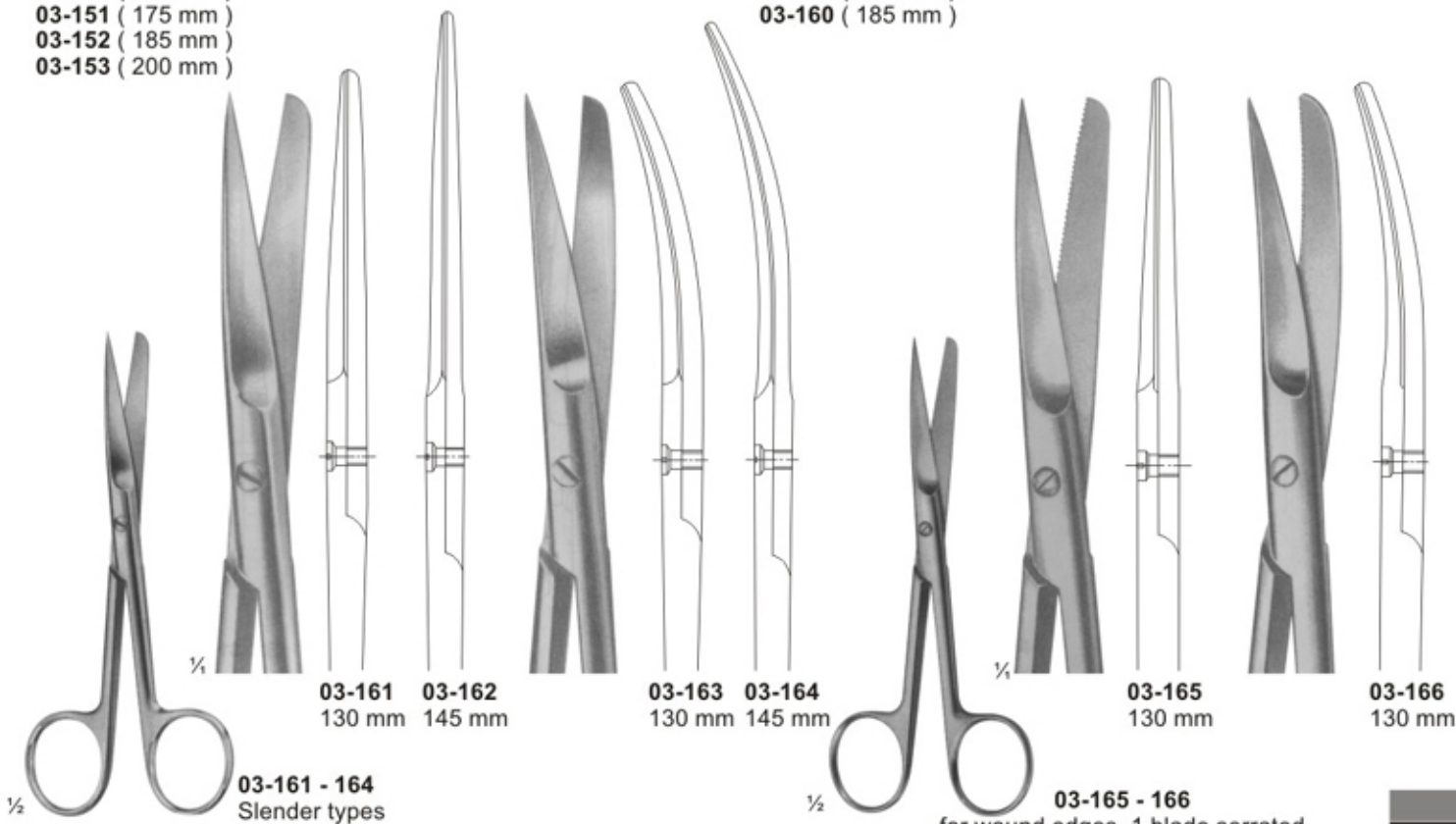

**03-161 - 164**  
 Slender types

**03-165 - 166**  
 for wound edges. 1 blade serrated

# Surgical Scissors



**03-167 - 169**  
DEAVER  
with flat lock

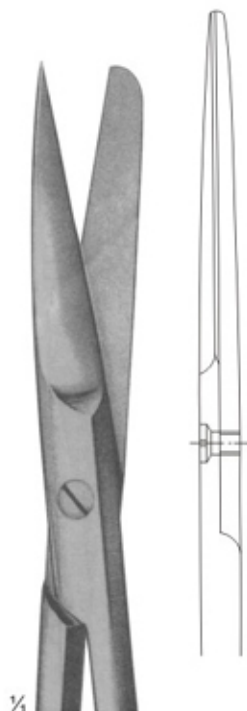

**03-167**  
Size: 145 mm

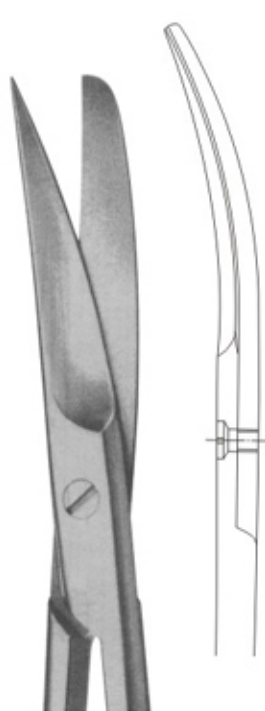

**03-168**  
Size: 145 mm

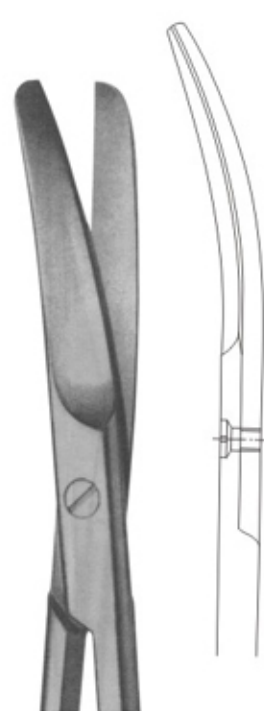

**03-169**  
Size: 145 mm



**03-170 - 172**  
Incision scissors



**03-170**  
Size: 130 mm



**03-171**  
Size: 145 mm



**03-172**  
Size: 165 mm



**03-173**  
SYSTRUNK  
Nail splitting scissors

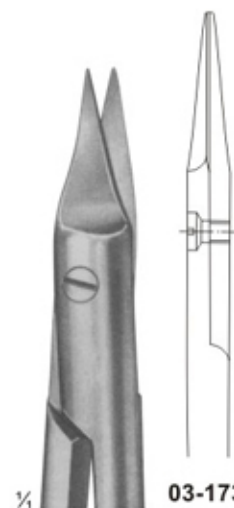

**03-173**  
Size: 130 mm





# Dissecting Scissors

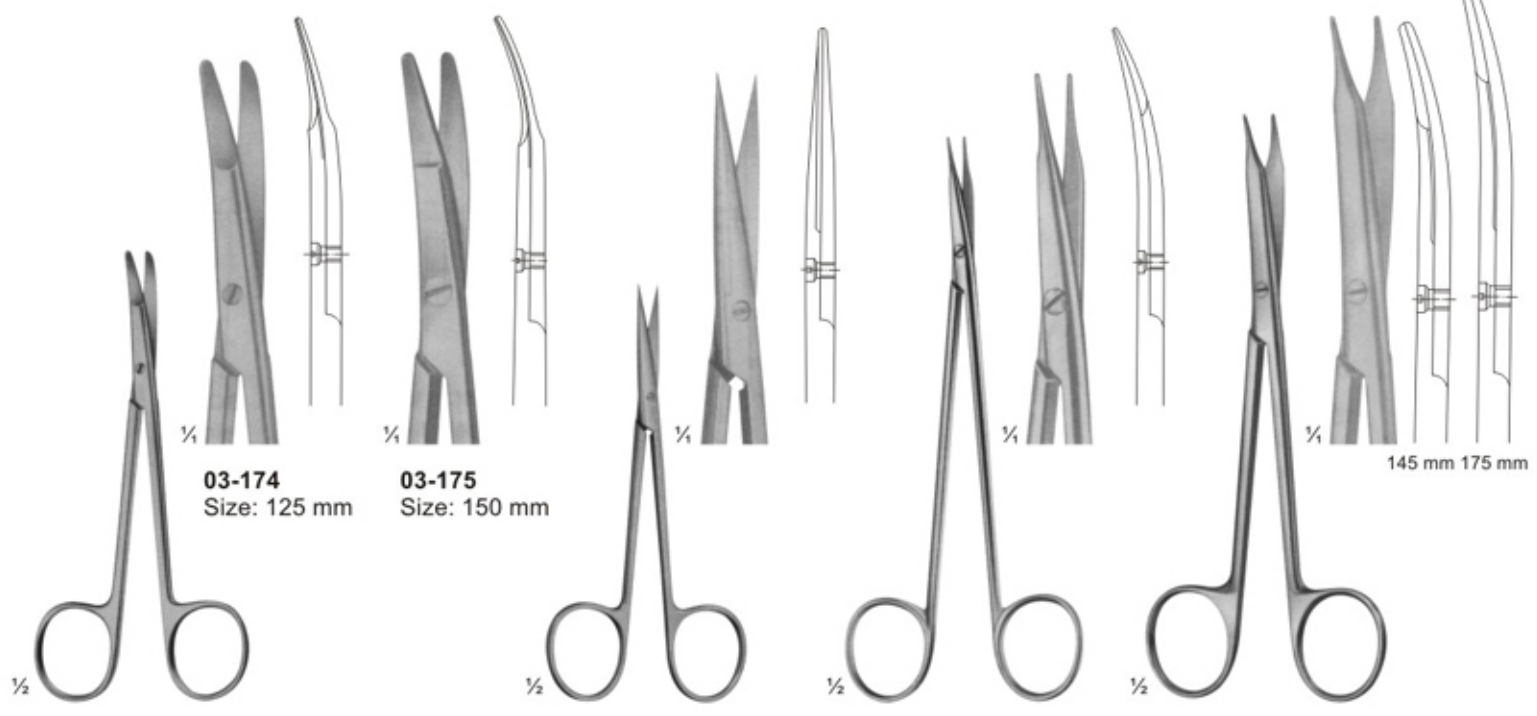

**03-174 - 175**  
KILNER  
Special flat points for dissecting and undermining the skin

**03-176**  
KILNER  
Fine dissecting scissors  
Size: 115 mm

**03-177**  
JAMESON  
Dissecting scissors  
Size: 150 mm

**03-178**  
REYNOLDS  
Dissecting scissors  
Size: 145 - 175 mm

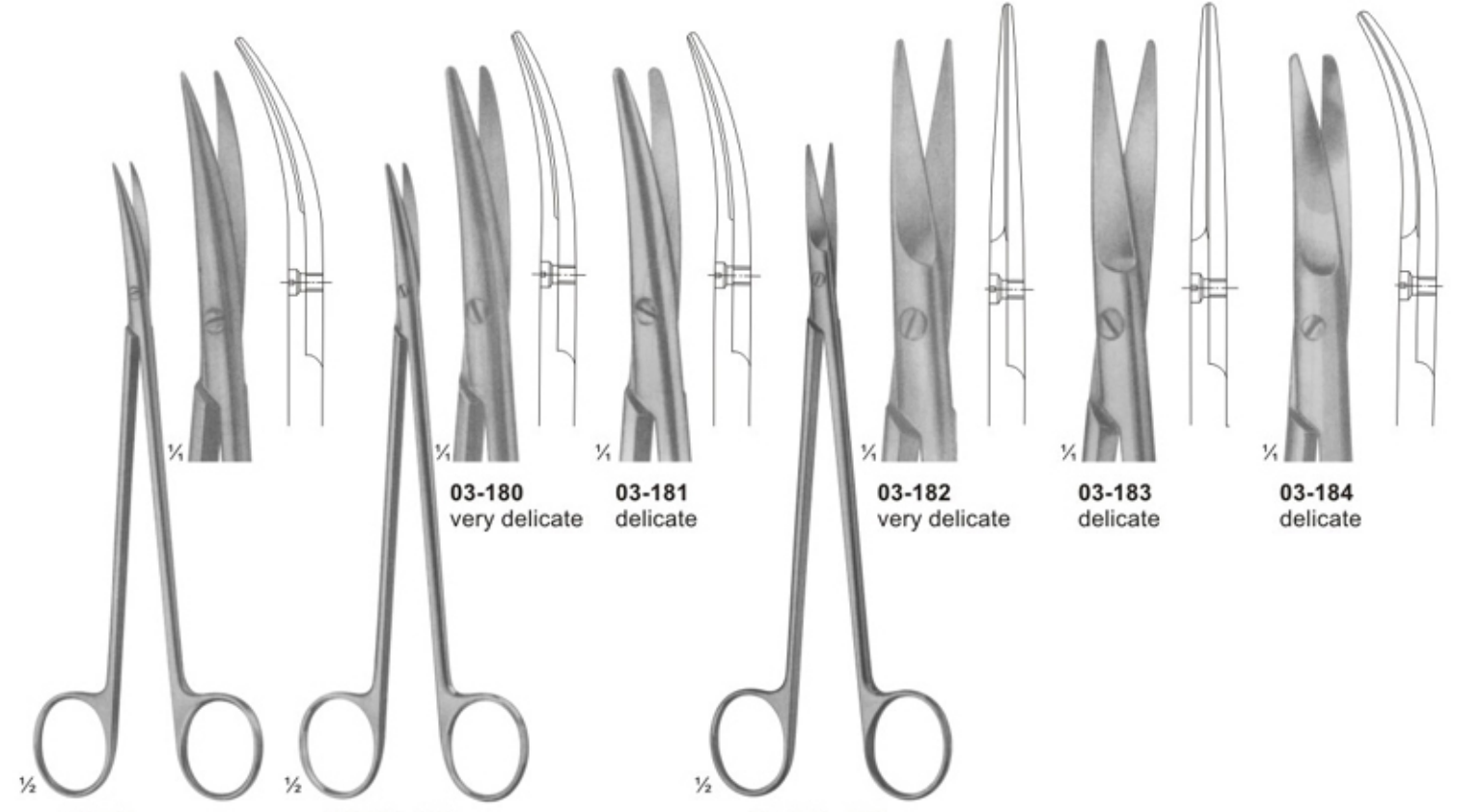

**03-179**  
DE BAKEY  
Arteriotomy scissors  
Size: 175 mm

**03-180 - 181**  
TOENNIS ADSON  
Dissecting scissors  
Size: 175 mm

**03-182 - 184**  
TOENNIS  
Dissecting scissors  
Size: 180 mm



# Dissecting Scissors

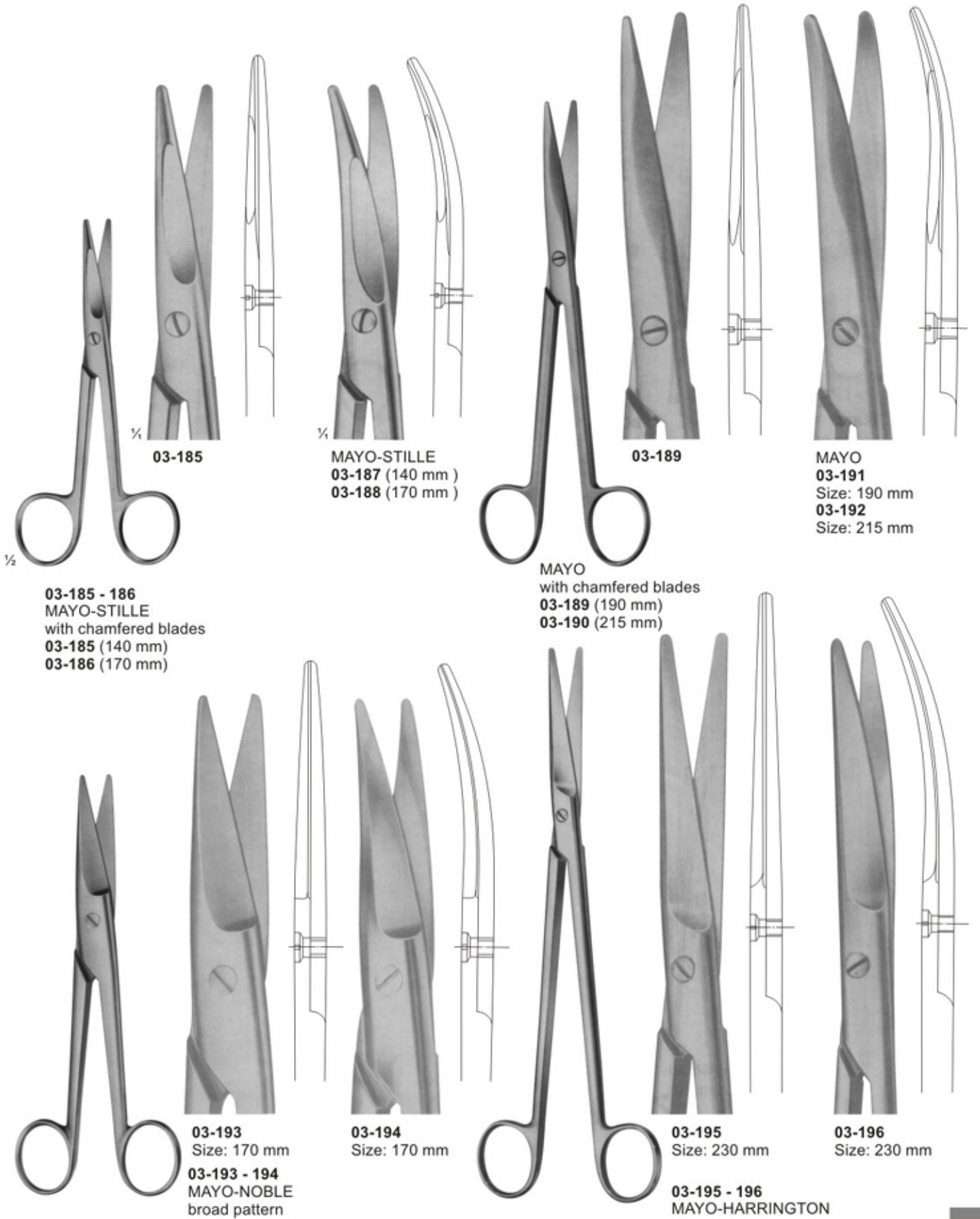



**Benodict**  
SURGICAL INSTRUMENTS

## Scissors for Cardiovascular and Neuro-Surgery



**03-197**  
OLIVECRONA  
Dura scissors

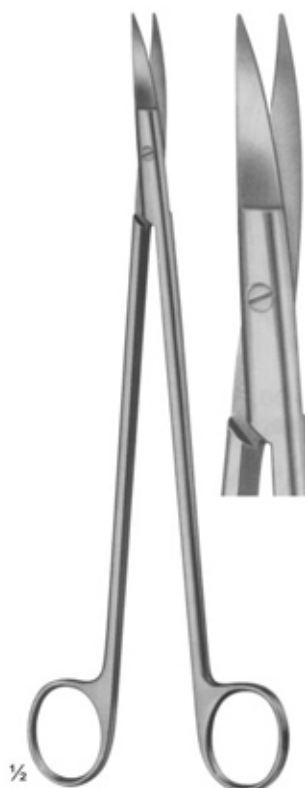

**03-198**  
STRULLY  
pointed  
Size: 220 mm

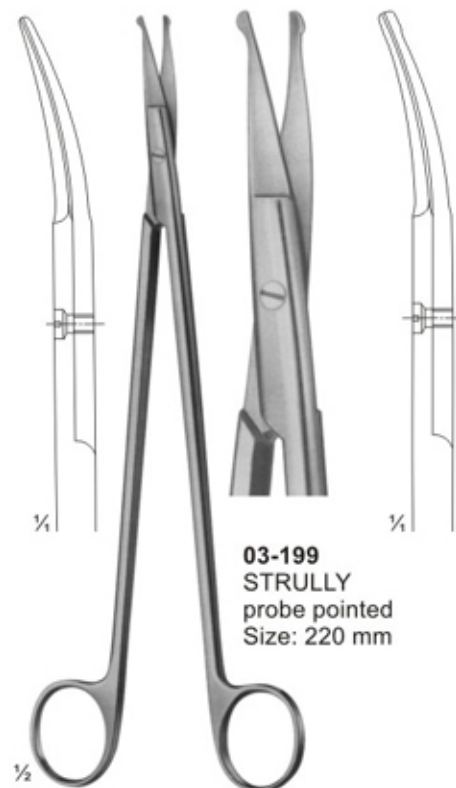

**03-199**  
STRULLY  
probe pointed  
Size: 220 mm

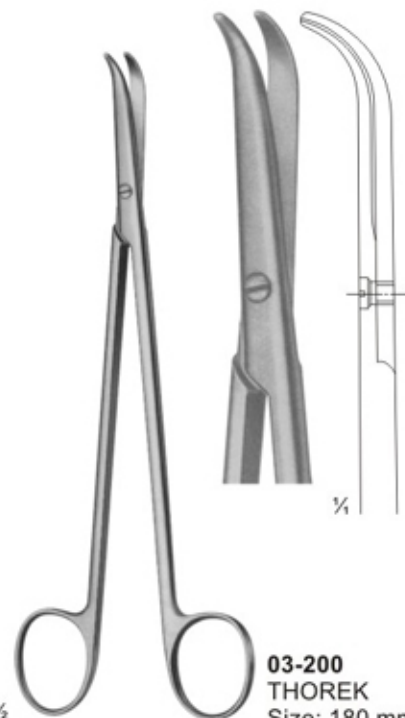

**03-200**  
THOREK  
Size: 180 mm

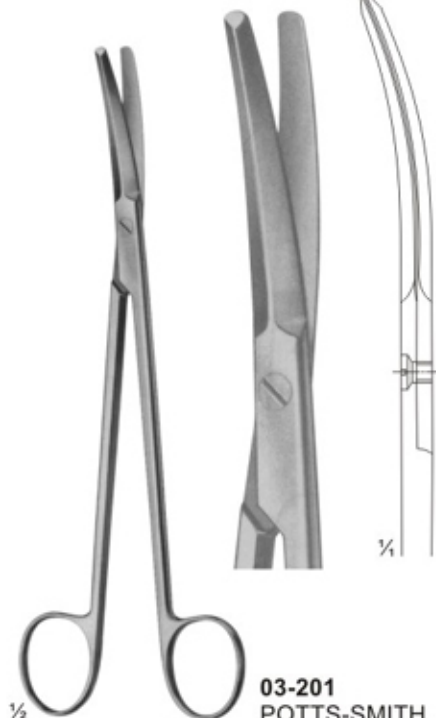

**03-201**  
POTTS-SMITH  
Size: 190 mm

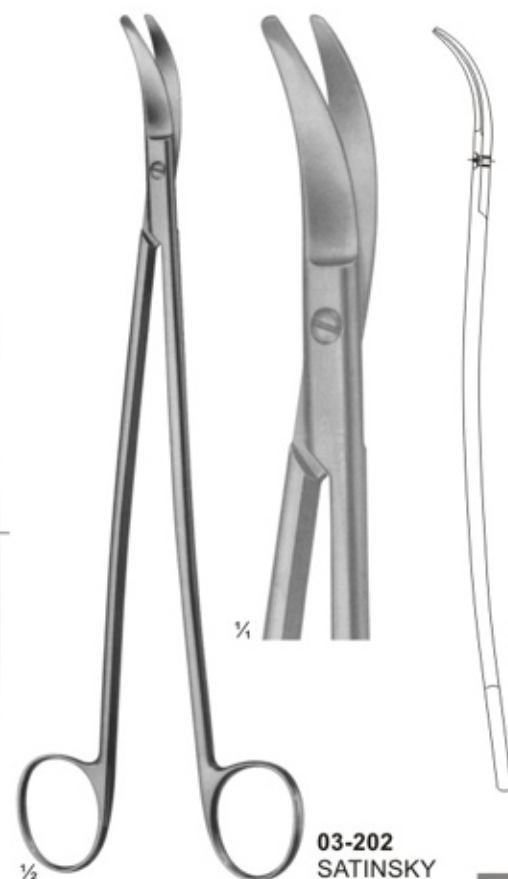

**03-202**  
SATINSKY  
Size: 245 mm

## Delicate, Nasal and Tonsil Scissors

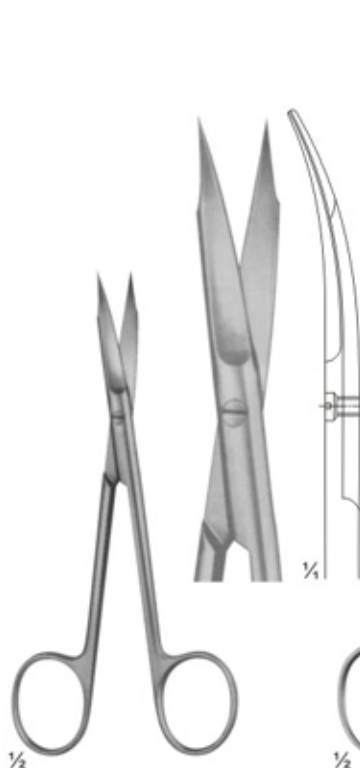

**03-203**  
1 finely toothed blade  
Size: 130 mm

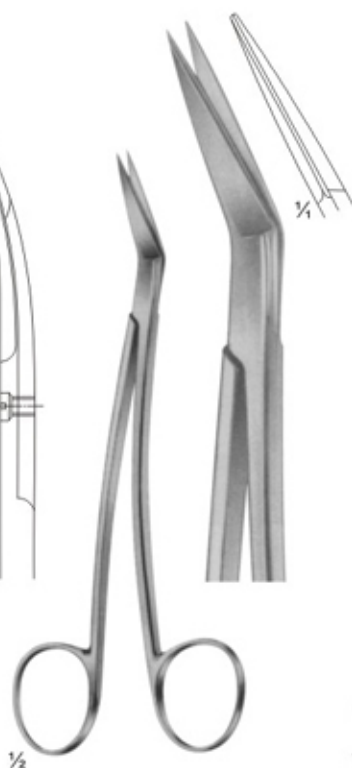

**03-204**  
LOCKLIN  
curved sideways,  
1 toothed blade  
Size: 155 mm



**03-205**  
FOMON  
blades serrated  
Size: 145 mm

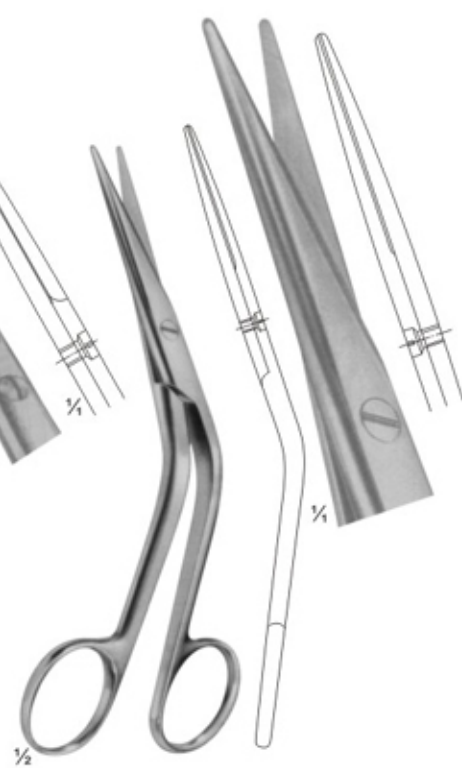

**03-206**  
COTTLE  
Size: 165 mm

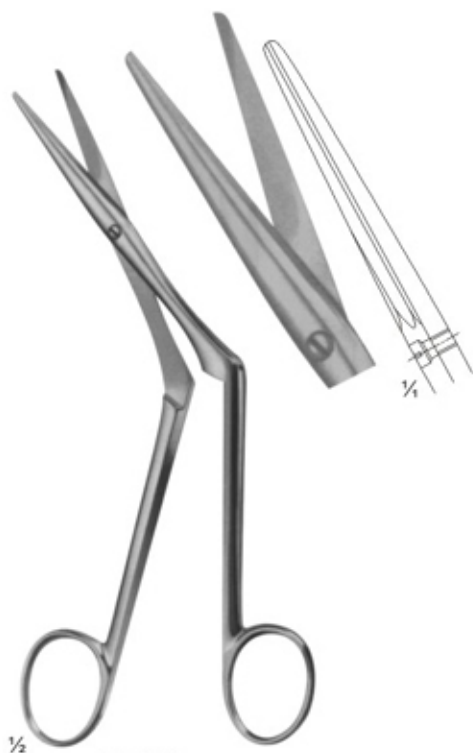

**03-207**  
HEYMAN-KNIGHT  
Size: 175 mm

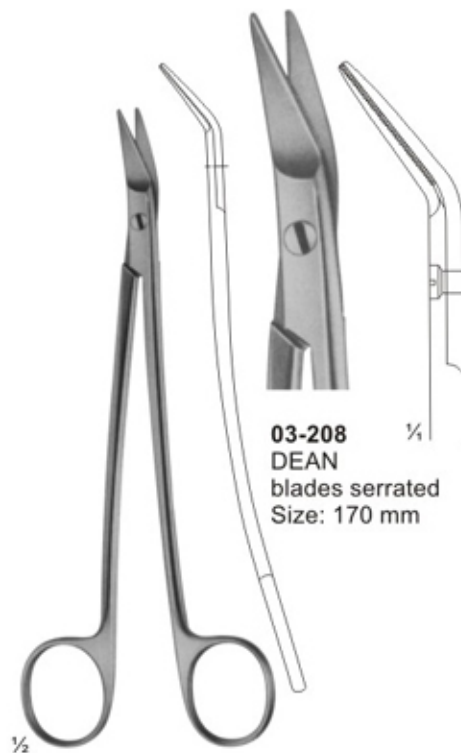

**03-208**  
DEAN  
blades serrated  
Size: 170 mm

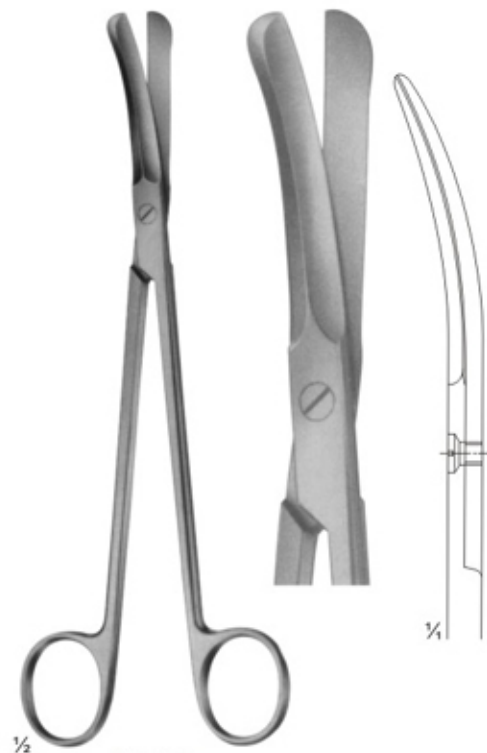

**03-209**  
GOOD  
Size: 195 mm





**Benodict**  
SURGICAL INSTRUMENTS

## Bone Shears

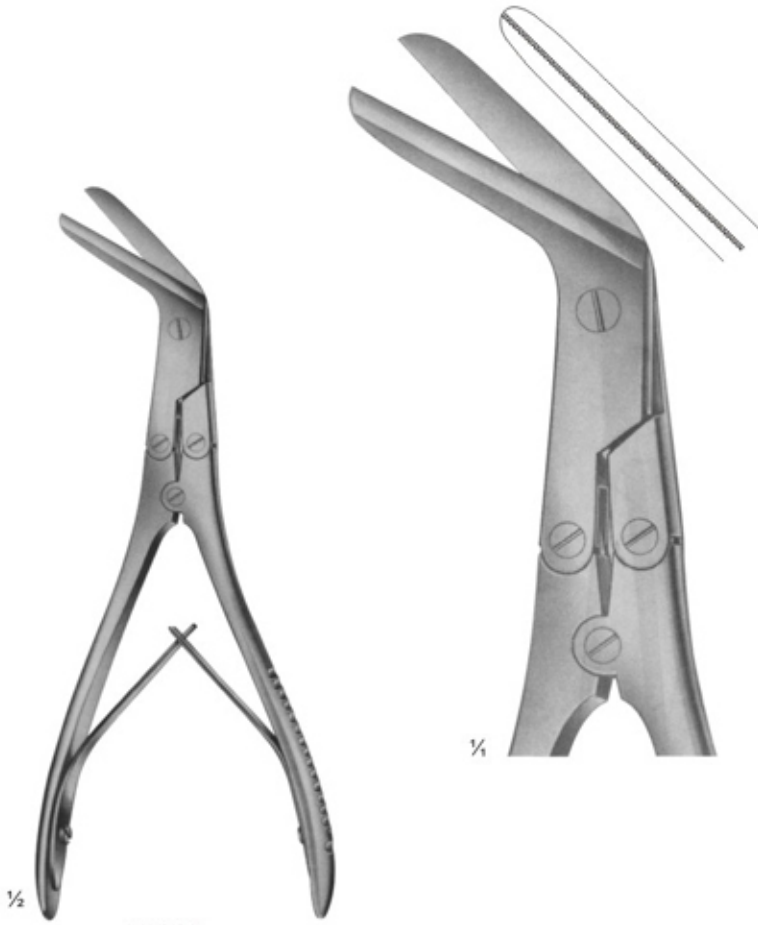

**03-210**  
KILLIAN  
Size: 200 mm



**03-211 - 03-212**

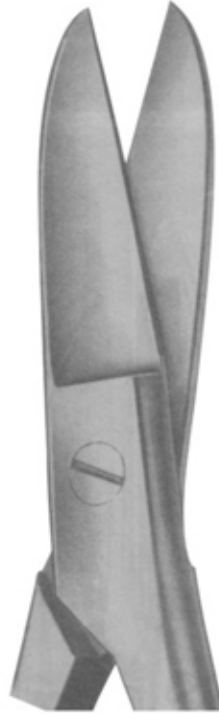

**03-211**  
195 mm



**03-212**  
225 mm



**Scissors for deep operations and  
for Gynaecology**

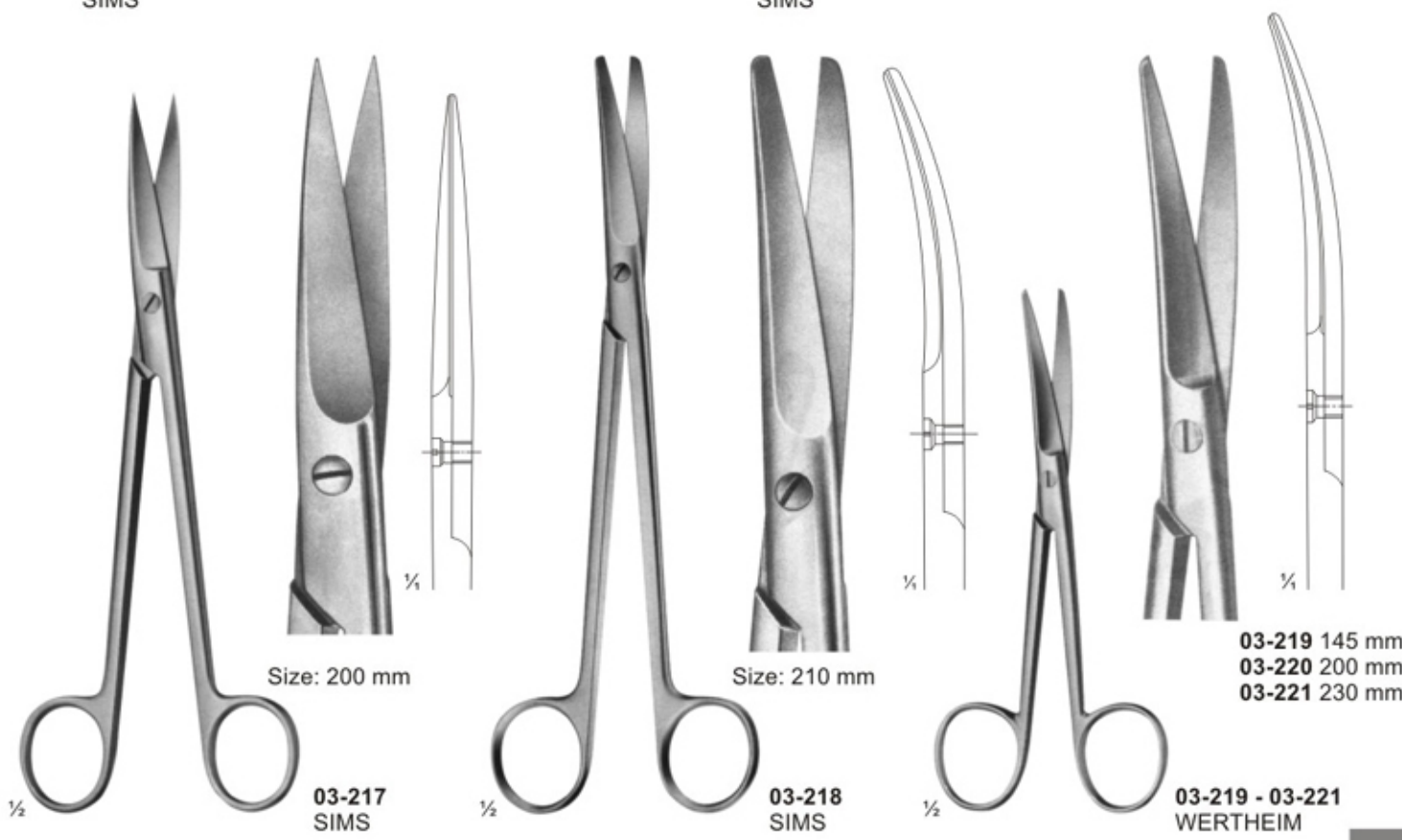
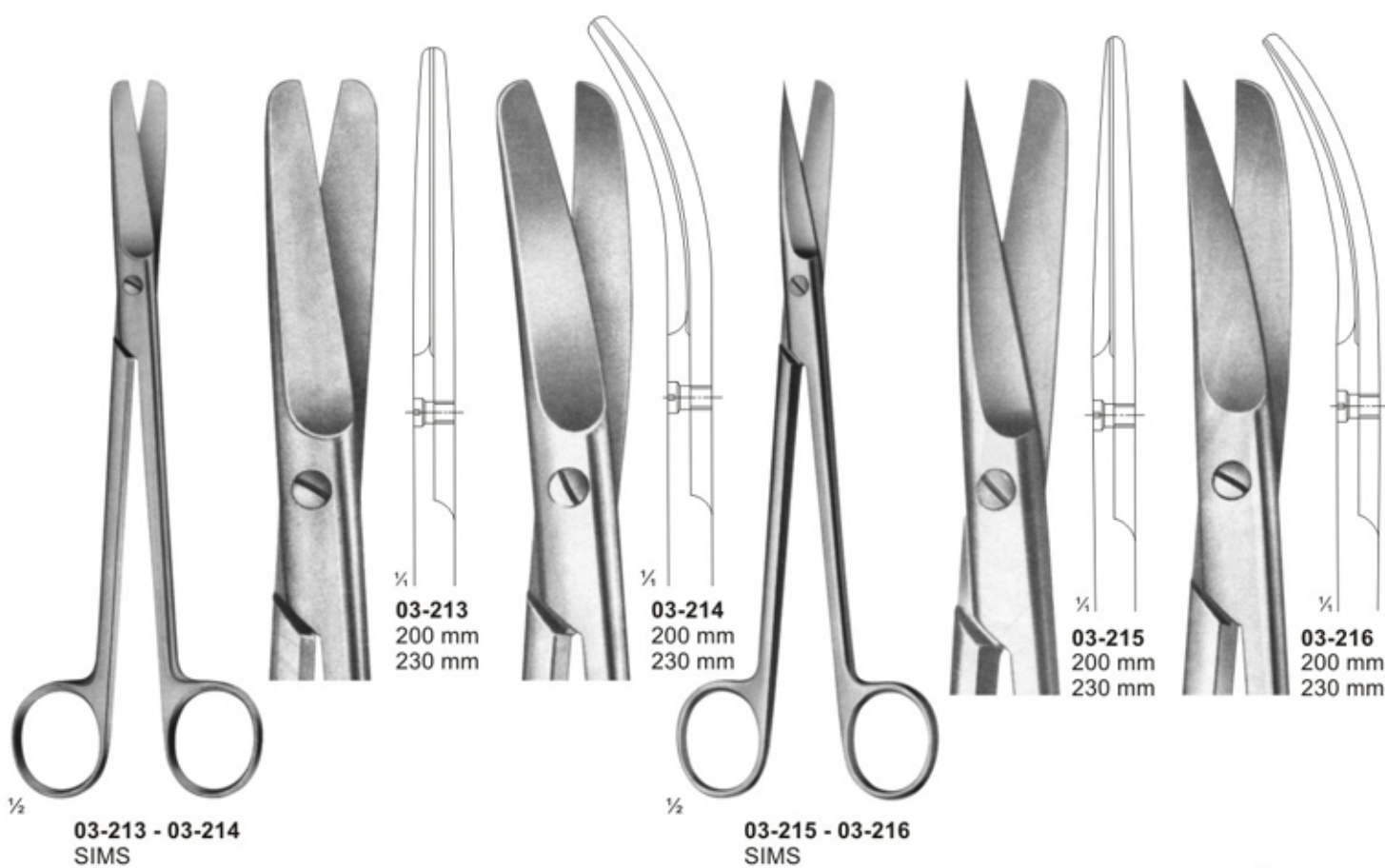

## Scissors for Obstetrics



**03-222**  
**SCHUMACHER**  
Umbilical cord scissors  
Size: 155 mm

**03-223**  
Umbilical cord scissors  
Size: 105 mm

**03-224**  
Umbilical cord scissors

135 mm

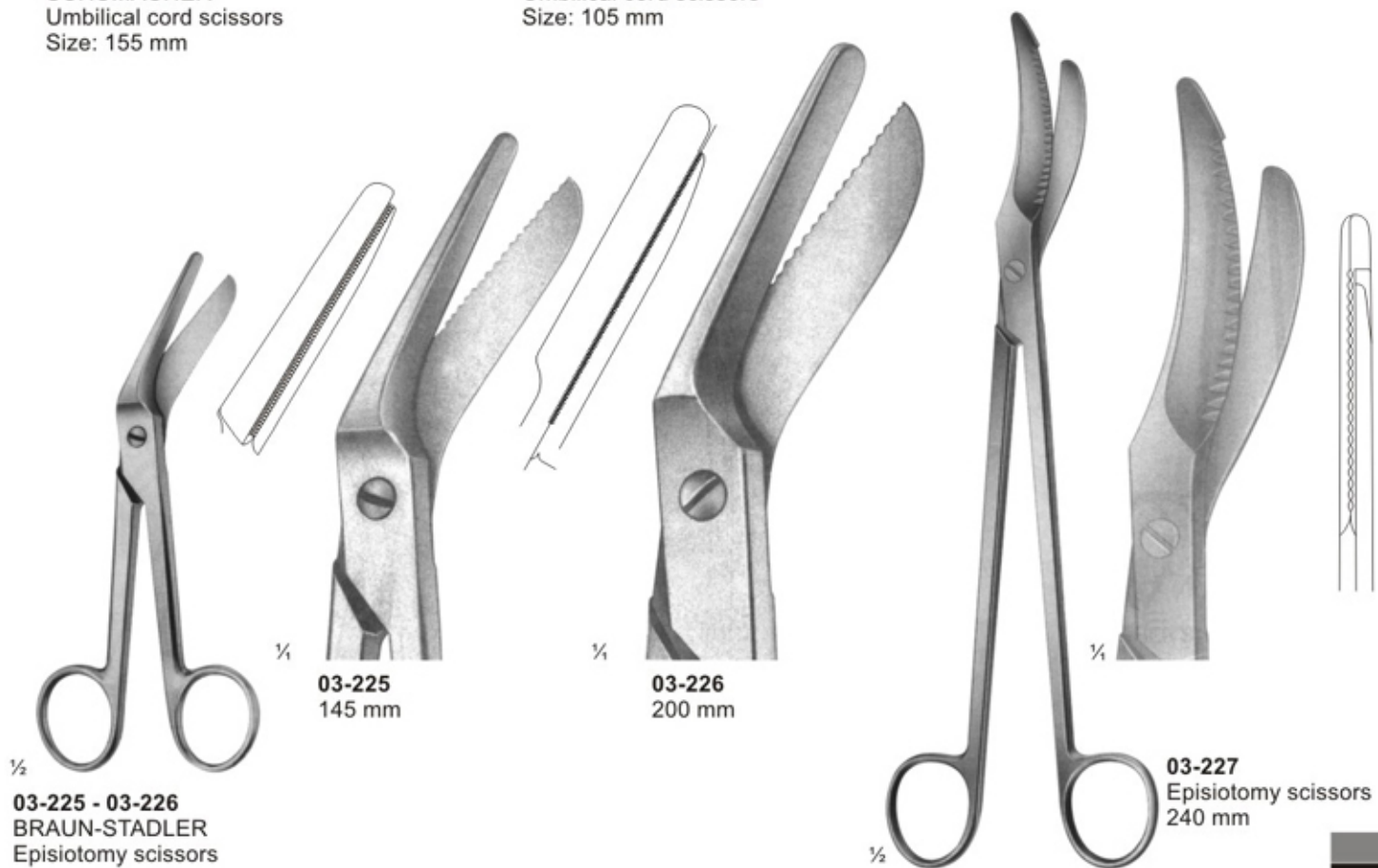

**03-225 - 03-226**  
**BRAUN-STADLER**  
Episiotomy scissors

**03-225**  
145 mm

**03-226**  
200 mm

**03-227**  
Episiotomy scissors  
240 mm

## Wire and Plate Scissors

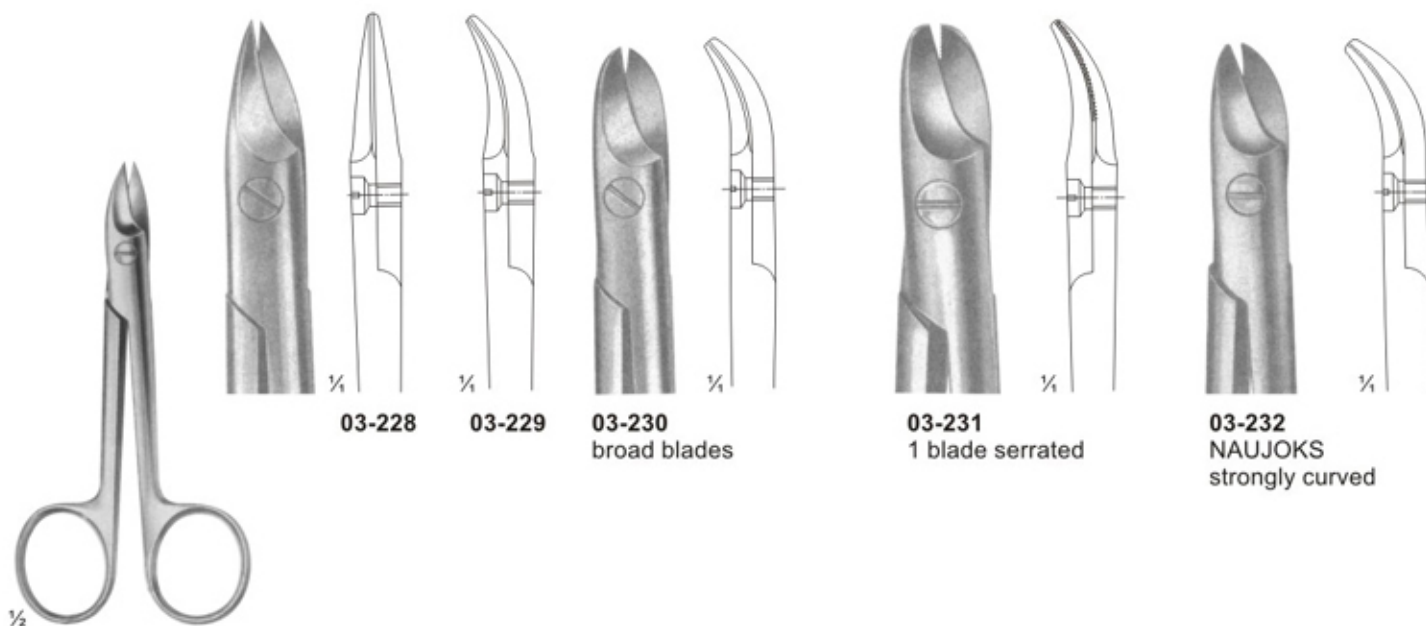

**03-228 - 03-232**  
BEEBE  
Size: 110 mm

03-228

03-229

03-230  
broad blades

03-231  
1 blade serrated

03-232  
NAUJOKS  
strongly curved

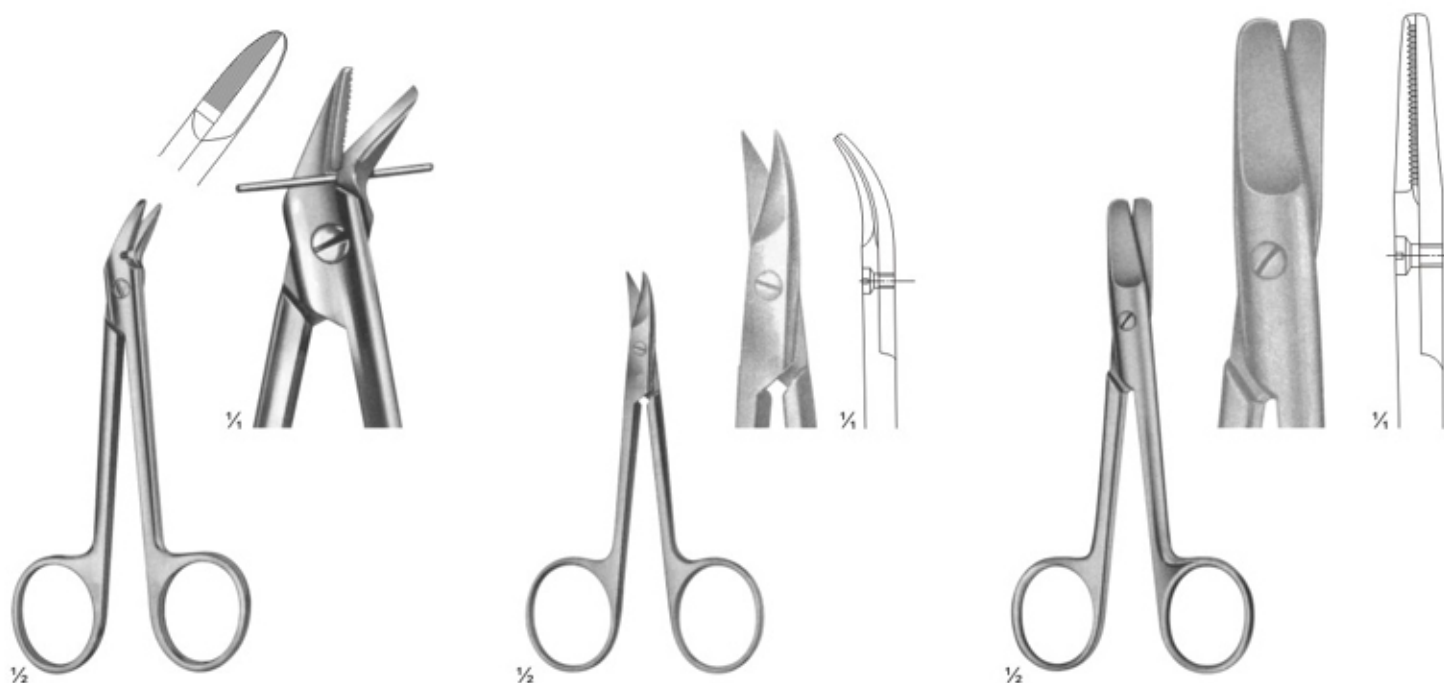

**03-233**  
1 blade serrated  
Size: 120 mm

**03-234**  
STRACK  
Size: 100 mm

**03-235**  
HARVEY  
blades serrated  
Size: 125 mm



# Bandage and Cloth Scissors



**03-236**  
 Universal bandage and cloth scissors,  
 with toothed edges  
 180 mm



**03-237**  
 LISTER  
 Universal bandage and cloth scissors,  
 with toothed edges  
 Size: 145 mm

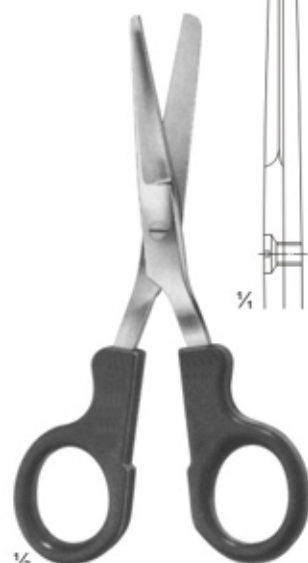

**03-238**  
 LISTER  
 Nurse's scissors  
 Size: 145 mm



**03-239 - 03-242**  
 LISTER

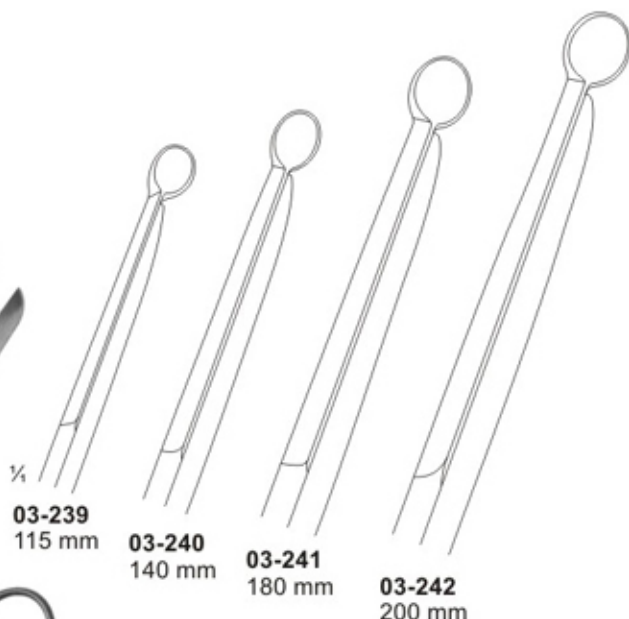

**03-239**  
 115 mm

**03-240**  
 140 mm

**03-241**  
 180 mm

**03-242**  
 200 mm

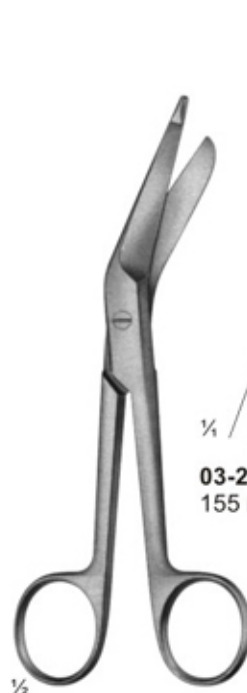

**03-243 - 03-244**  
 LISTER

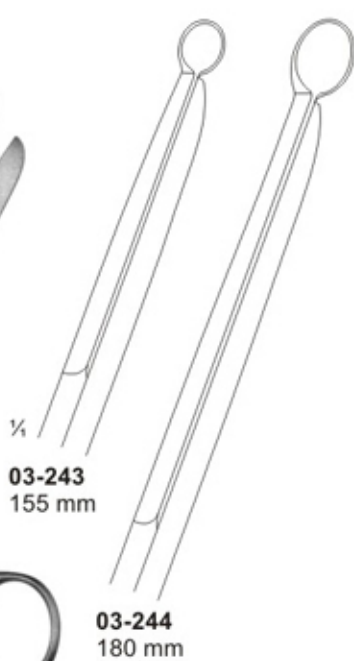

**03-243**  
 155 mm

**03-244**  
 180 mm



**Benodict**  
SURGICAL INSTRUMENTS

## Bandage-, Cloth-, and Plaster Scissors



**03-245**  
CLOTH SCISSORS  
205 mm

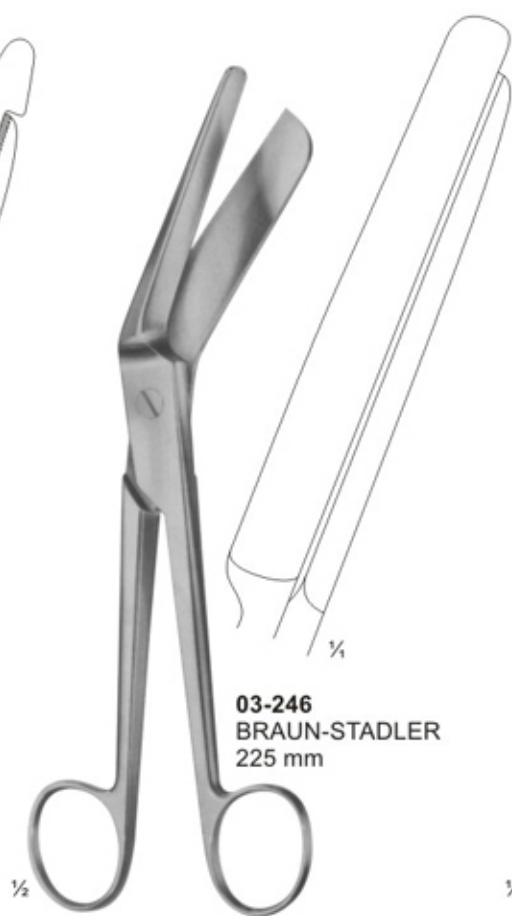

**03-246**  
BRAUN-STADLER  
225 mm



**03-247**  
SEUTIN  
230 mm



**03-248** 200 mm  
**03-249** 230 mm

**03-248 - 03-249**  
ESMARCH

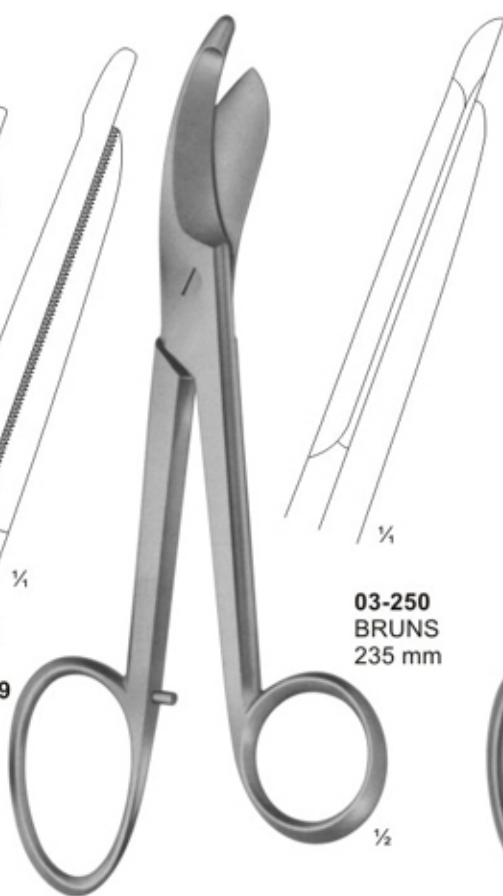

**03-250**  
BRUNS  
235 mm

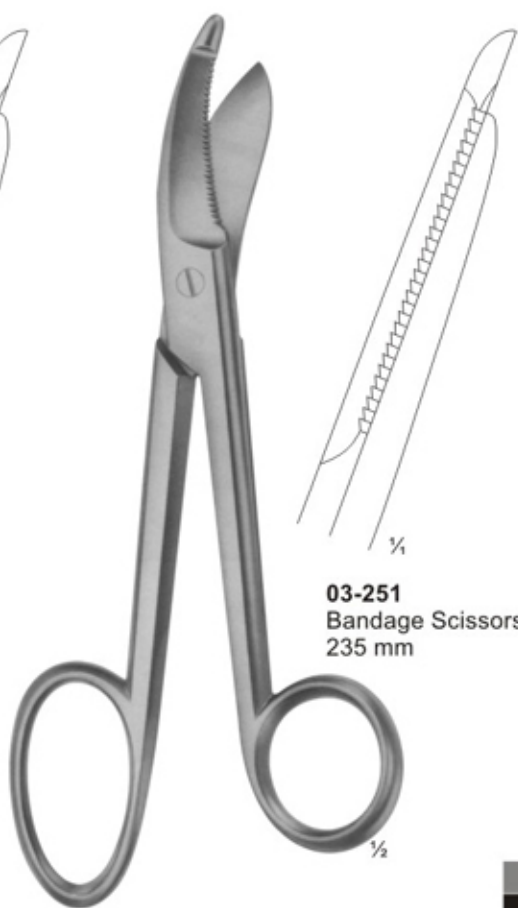

**03-251**  
Bandage Scissors  
235 mm



# Forceps for grasping tissue, tumors etc.



04-101 04-102 04-103

**04-101 - 103**  
YASARGIL-SAMII  
Jaws spoon-shaped  
240 mm



04-104 04-105

**04-104 - 105**  
YASARGIL  
Jaws spoon-shaped  
220 mm

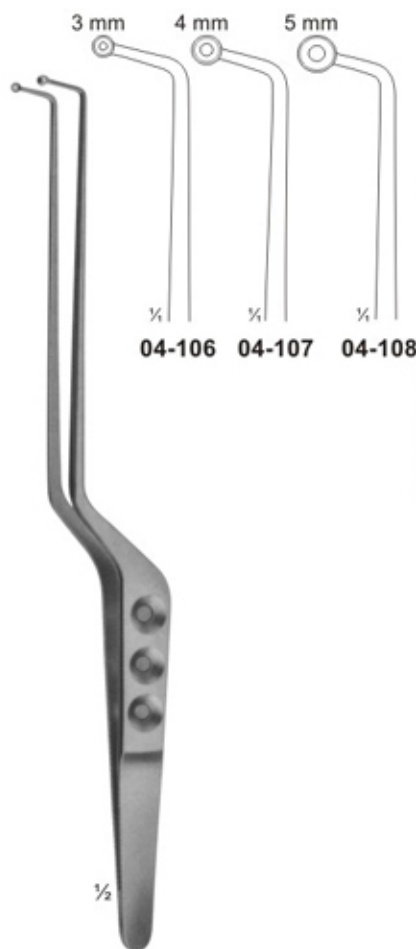

04-106 04-107 04-108

**04-106 - 108**  
SAMII  
Jaws spoon-shaped  
230 mm



04-109 04-110 04-111

**04-109 - 111**  
SAMII  
Jaws spoon-shaped  
230 mm

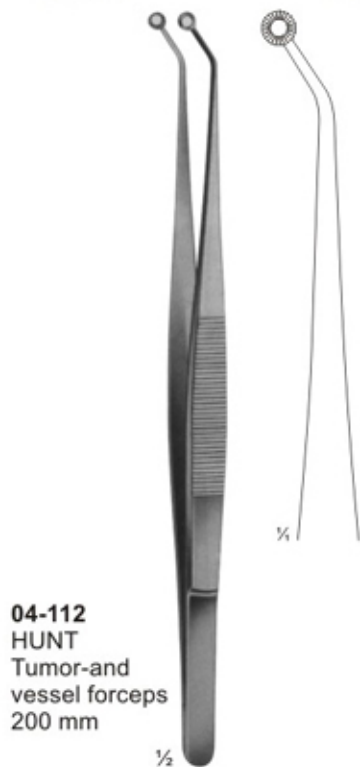

**04-112**  
HUNT  
Tumor-and  
vessel forceps  
200 mm



**04-113**  
HUNT  
Tumor-and  
vessel forceps  
200 mm



**04-114**  
YASARGIL  
Tumor-and  
vessel forceps  
200 mm



**Benodict**  
SURGICAL INSTRUMENTS

## Delicate Dissecting, Microscopic, Sterilizing Forceps

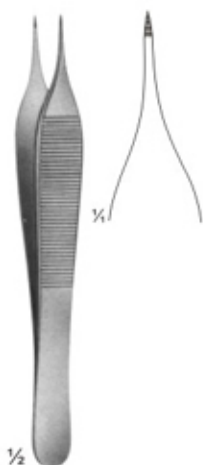

**04-115**  
THORPE  
Corneal forceps  
120 mm

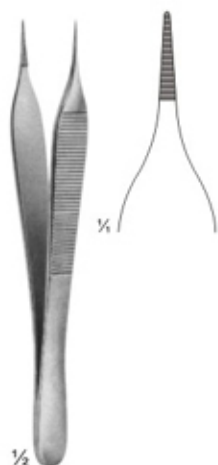

**04-116**  
MICRO-ADSON  
120 mm

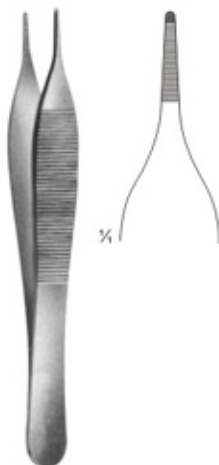

**04-117**  
ADSON  
120 mm



**04-118**  
MICRO-ADSON  
150 mm

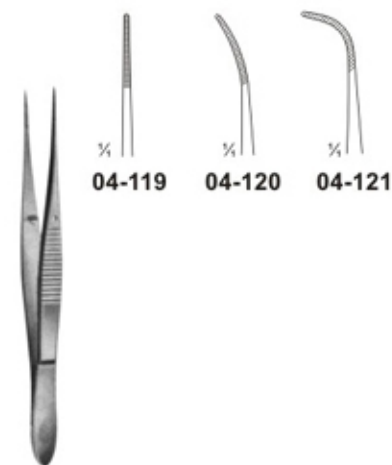

**04-119 - 121**  
100 mm

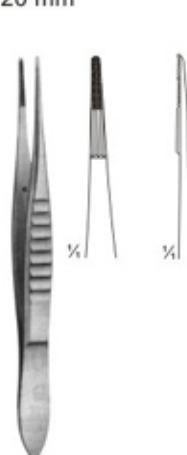

**04-122**  
BONACCOLTO  
110 mm

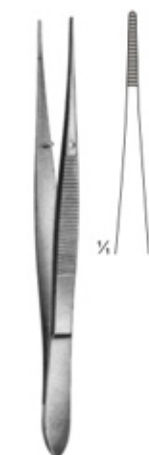

**04-123**  
115 mm

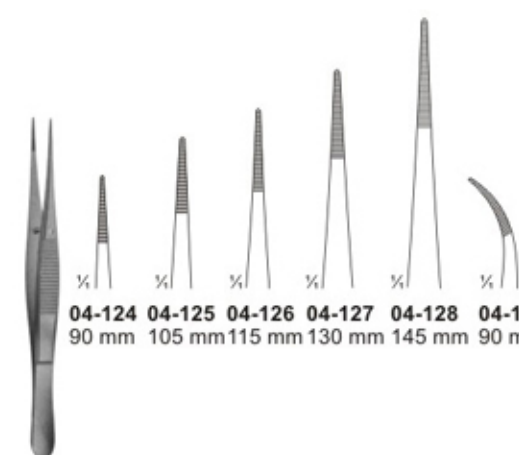

**04-124 - 133**

**04-124** 90 mm **04-125** 105 mm **04-126** 115 mm **04-127** 130 mm **04-128** 145 mm **04-129** 90 mm **04-130** 105 mm **04-131** 115 mm **04-132** 130 mm **04-133** 145 mm



**04-134**  
100 mm

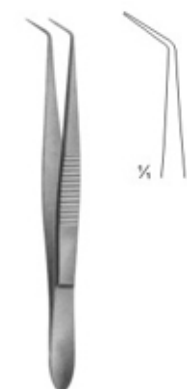

**04-135**  
100 mm



**04-136**  
100 mm

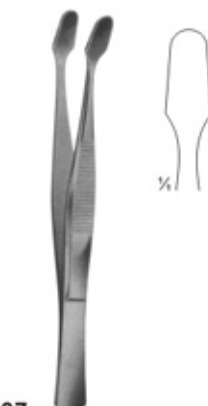

**04-137**  
KUHNE  
Cover glass forceps, 105 mm



**04-138**  
160 mm





# Delicate Dissecting Forceps

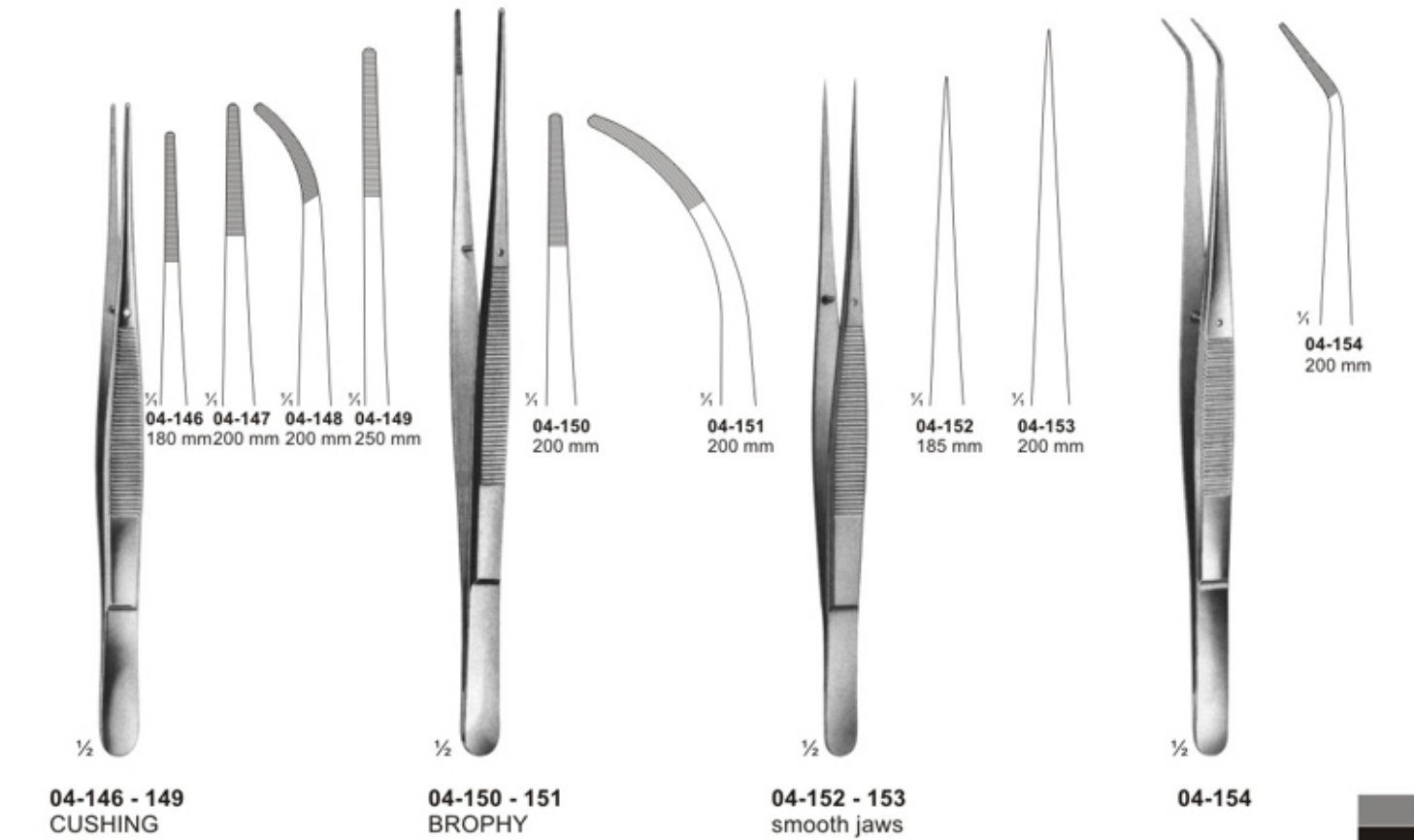
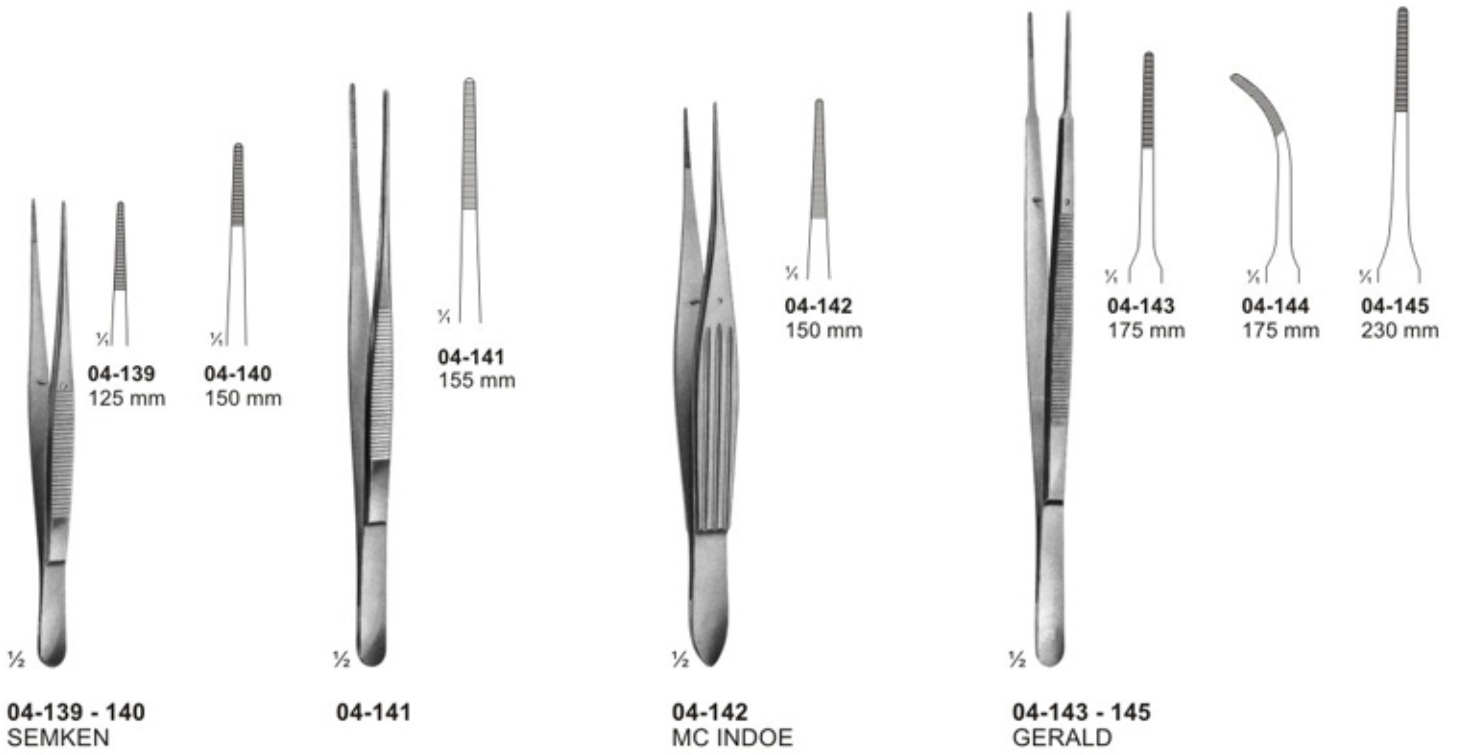

# Dissecting Forceps

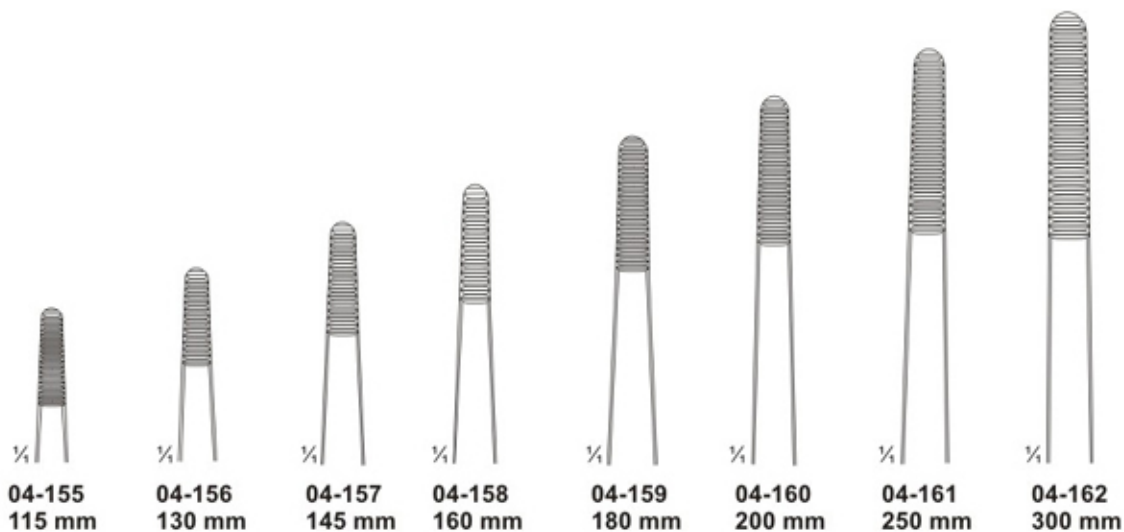

**04-155 - 04-162**  
STANDARD

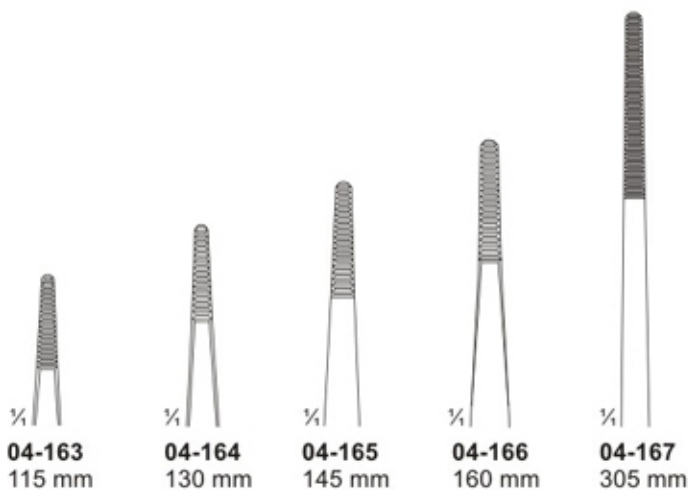

**04-163 - 04-167**  
MEDIUM



**04-168 - 04-169**  
MEDIUM



# Forceps

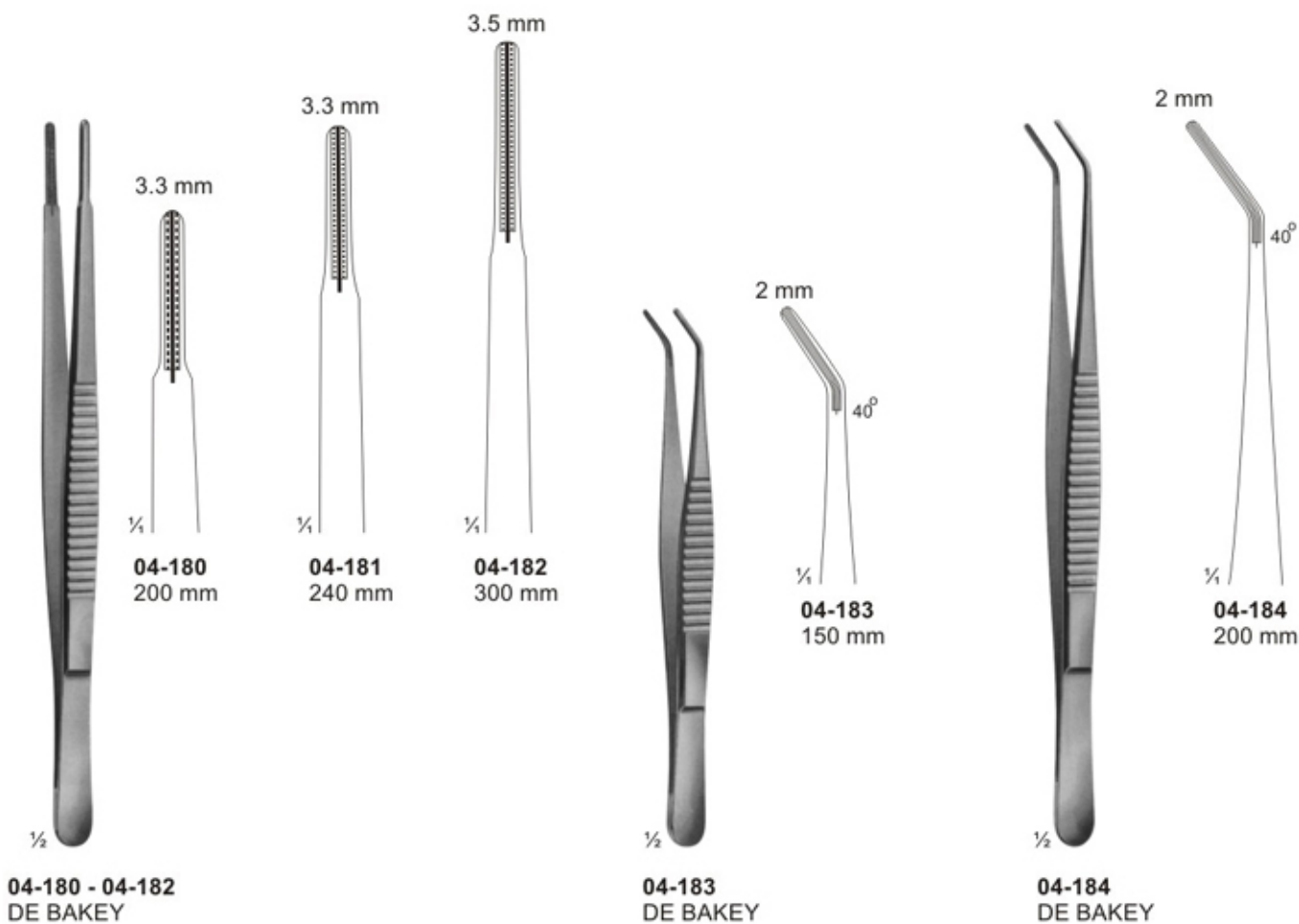
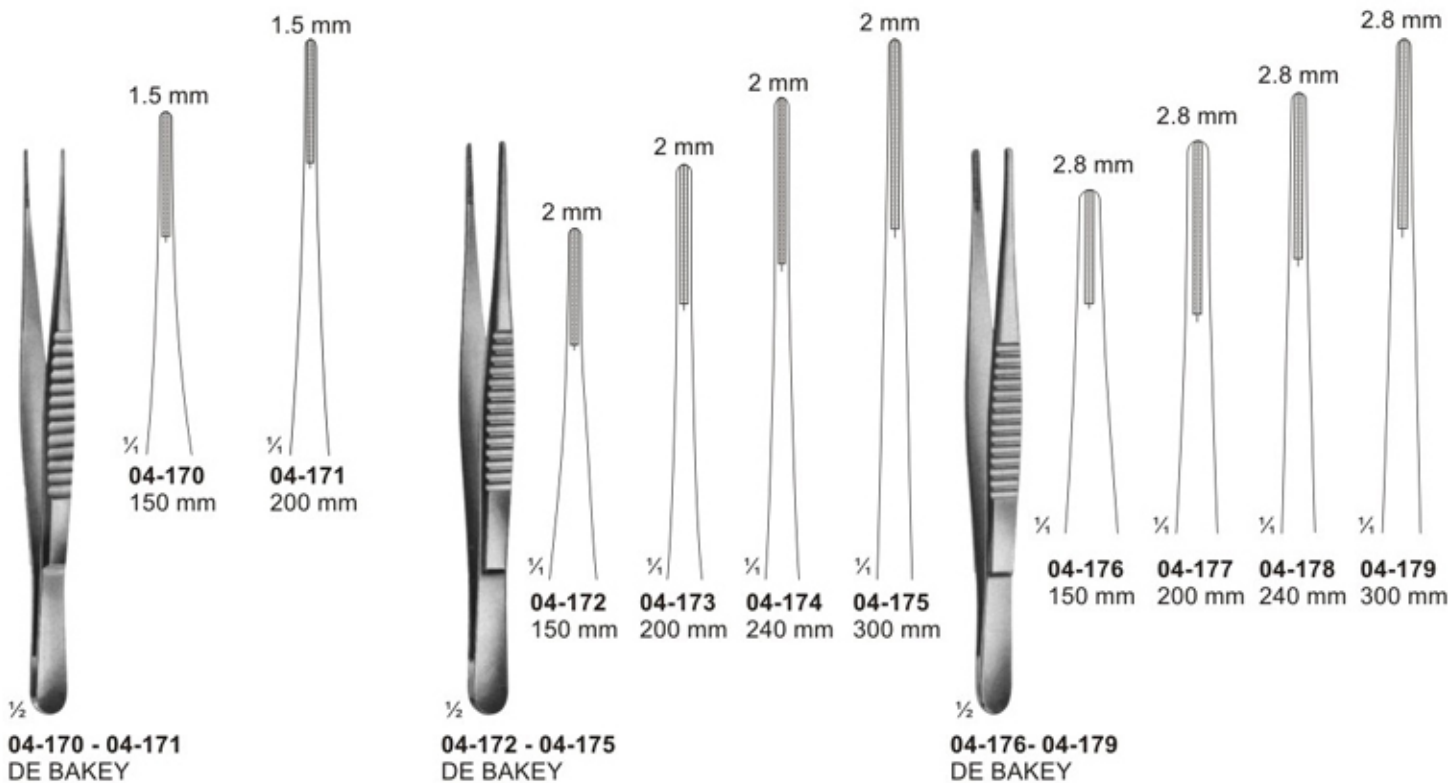

## Delicate Tissue Forceps



**04-185**  
BISHOP-HARMON  
85 mm

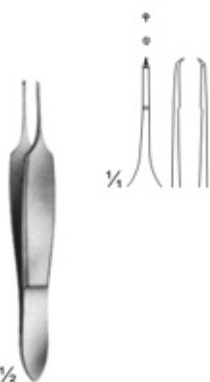

**04-186**  
ST.MARTIN  
80 mm

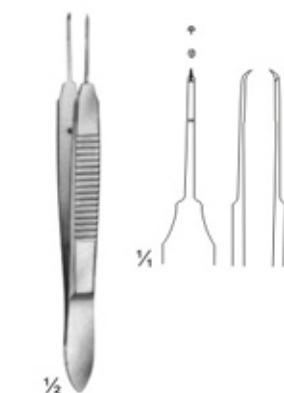

**04-187**  
CASTROVIEJO  
teeth 0.9 mm  
100 mm

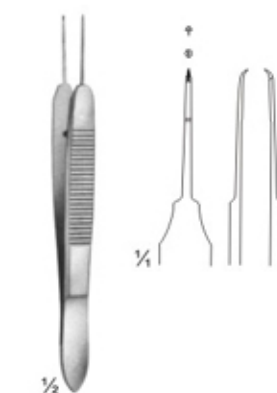

**04-188**  
CASTROVIEJO  
teeth 0.5 mm  
100 mm

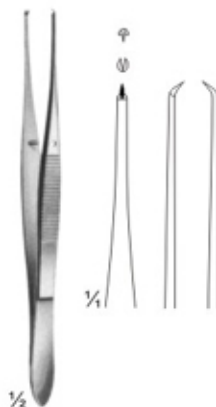

**04-189**  
ELSCHING  
110 mm

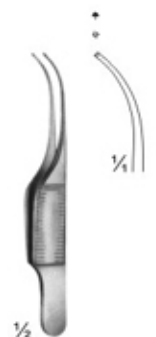

**04-190**  
GILL  
75 mm



**04-191**  
GILL - HESS  
75 mm

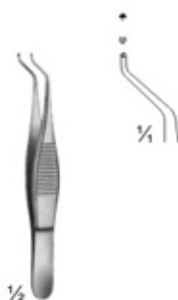

**04-192**  
HESS  
70 mm

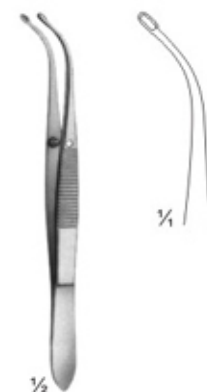

**04-193**  
ARRUGA  
100 mm



**04-194**  
SEMKEN

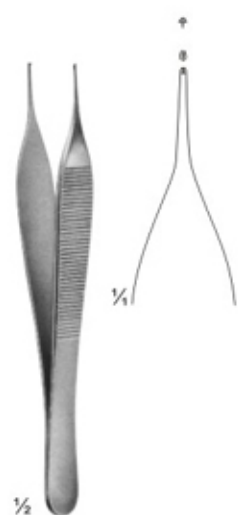

**04-195**  
MICRO-ADSON  
120 mm

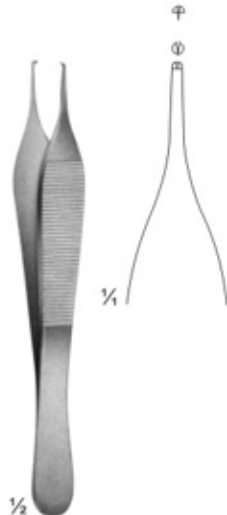

**04-196**  
ADSON  
120 mm



**04-197**  
ADSON  
120 mm



**04-198**  
ADSON  
120 mm



**04-199**  
ADSON  
150 mm





# Tissue Forceps

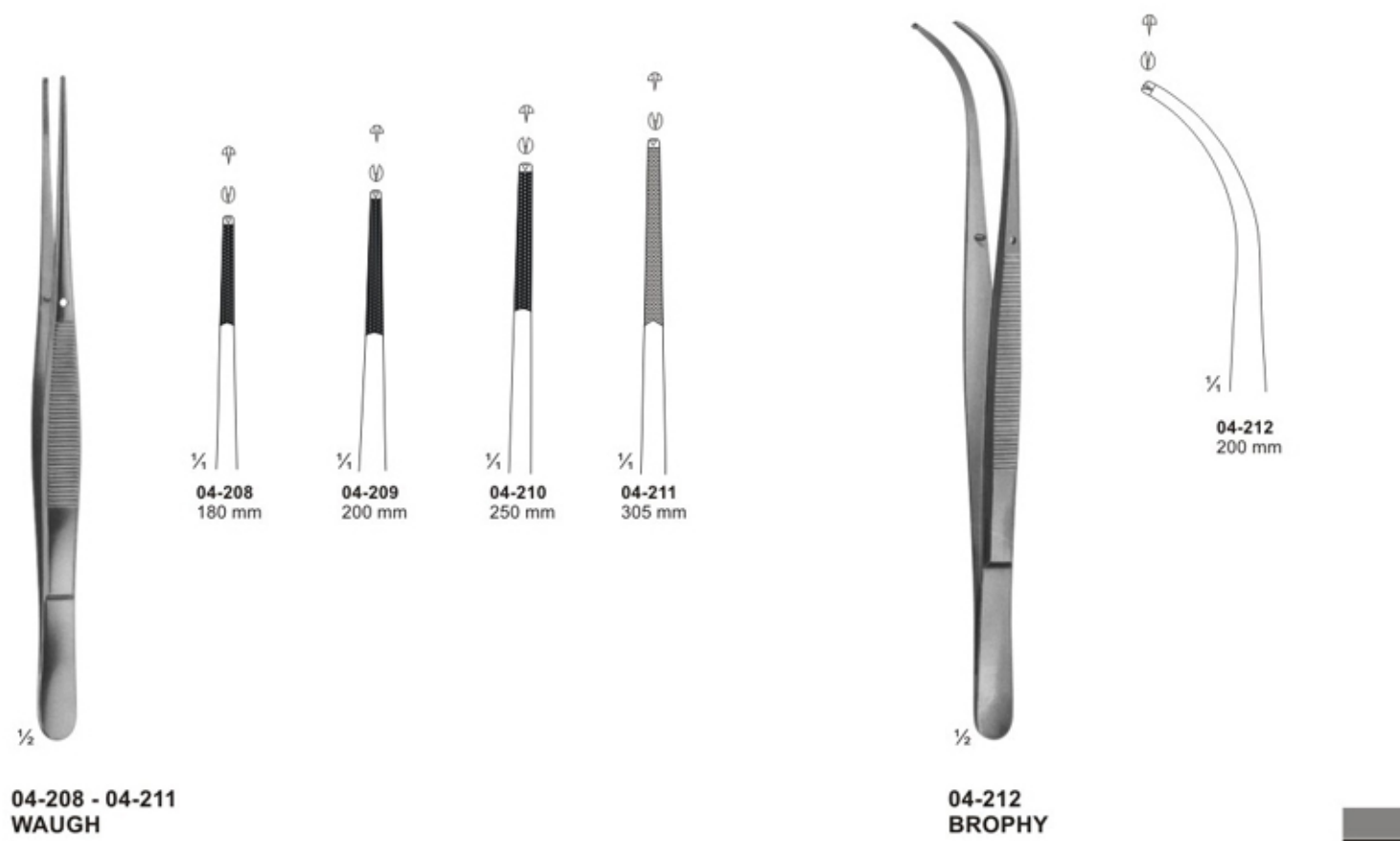
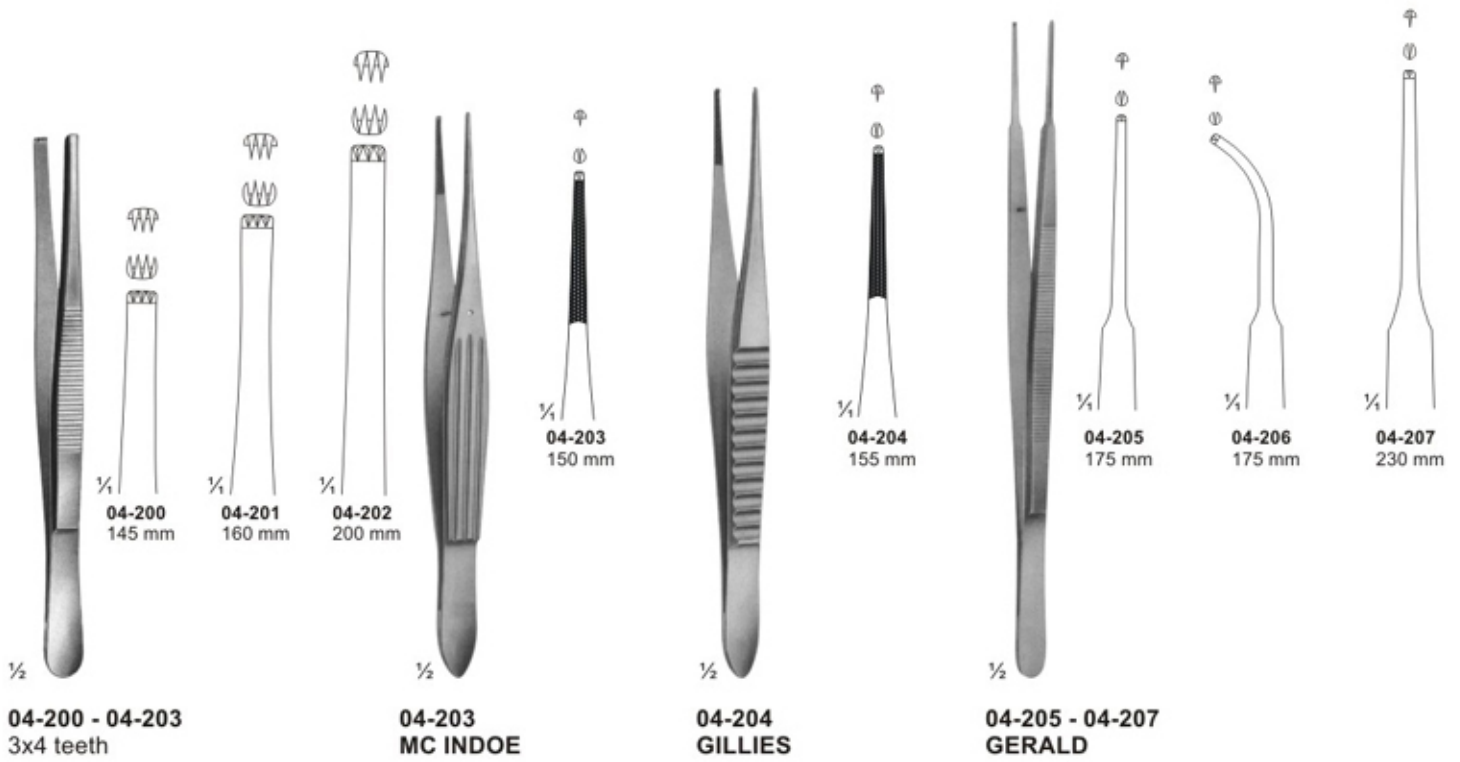

# Tissue Forceps

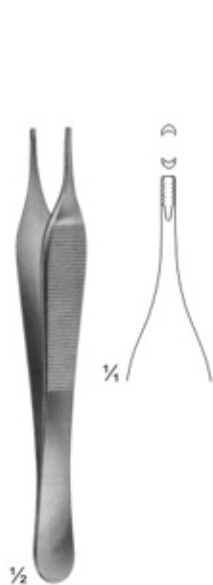

**04-213**  
**ADSON - BROWN**  
Non-traumatic  
120 mm

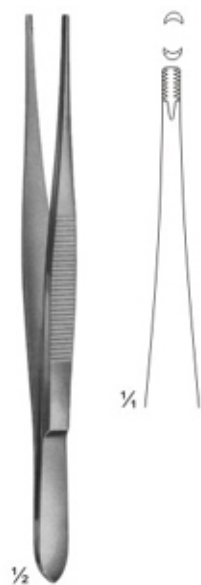

**04-214**  
**BROWN**  
120 mm



**04-215**  
**GRAEFE**  
110 mm

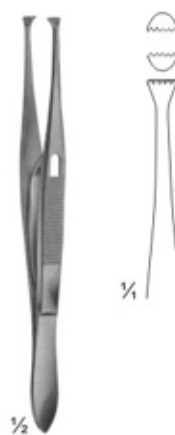

**04-216**  
**GRAEFE**  
With Catch  
110 mm

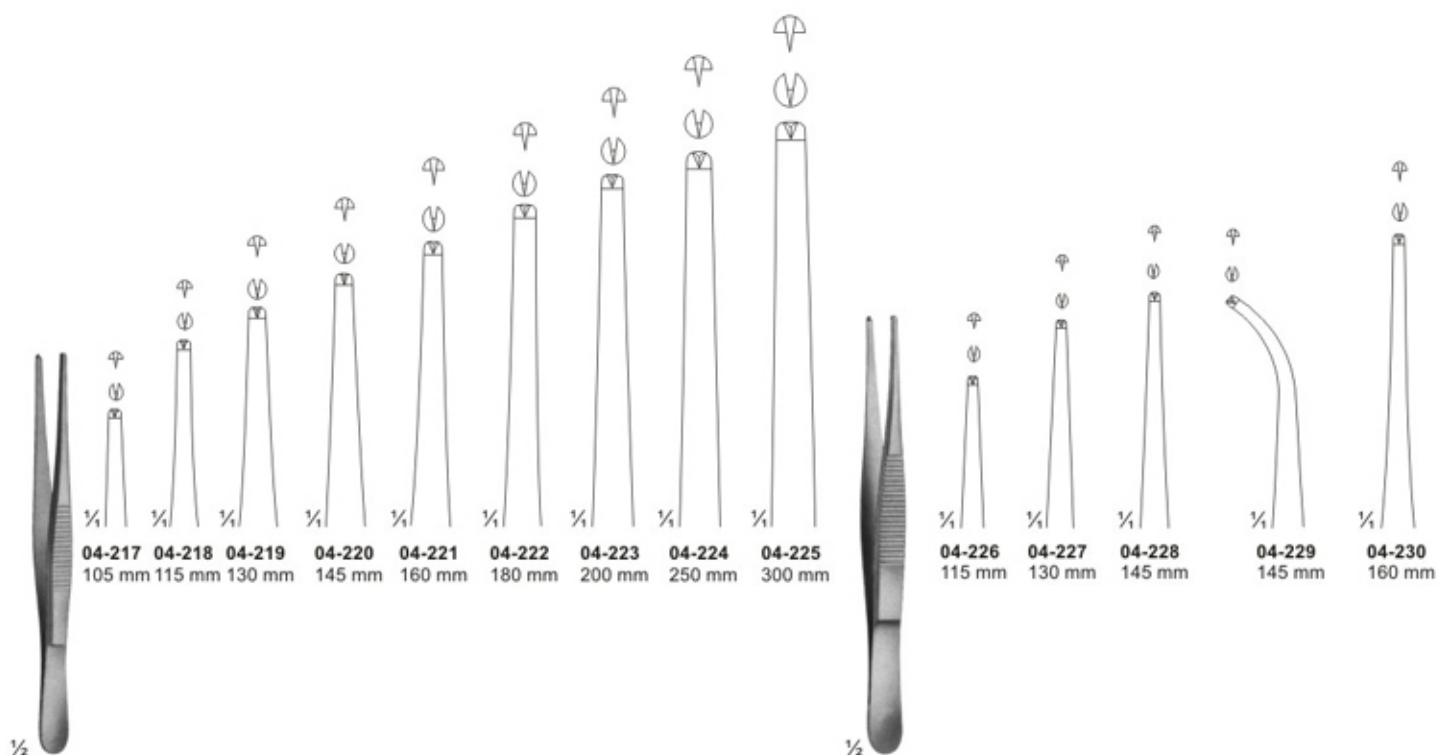

**04-217 - 04-225**  
**STANDARD**

**04-226 - 04-230**  
**GRAEFE**  
110 mm

## Forceps, Bayonet - Shaped

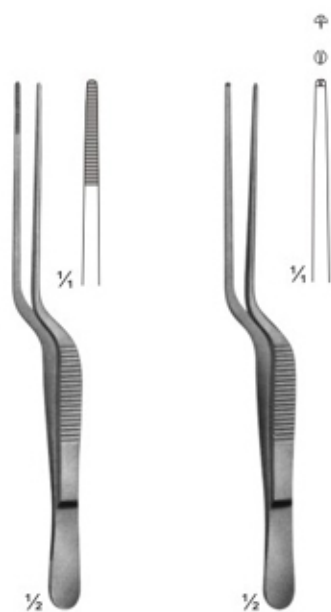

**04-231**  
LUCAE  
140 mm



**04-232**  
LUCAE  
1x2 teeth  
140 mm



**04-233**  
COTTLE  
Forceps with  
jaws toothed  
and serrated  
140 mm



**04-234**  
JANSEN  
160 mm

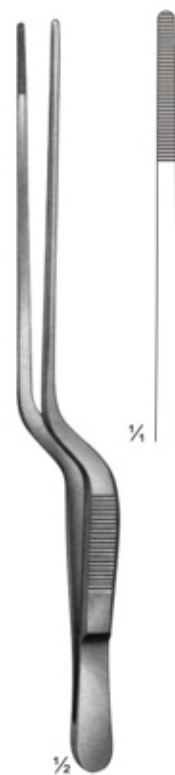

**04-235**  
GRUENWALD  
200 mm



**04-236**  
1x2 teeth  
200 mm



**04-237**  
TROELTSCH  
100 mm

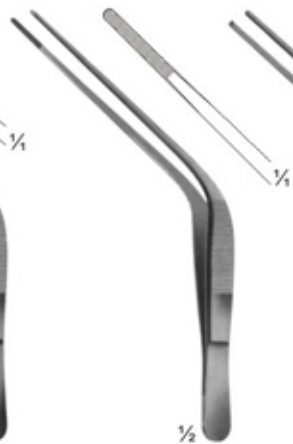

**04-238**  
TROELTSCH  
115 mm

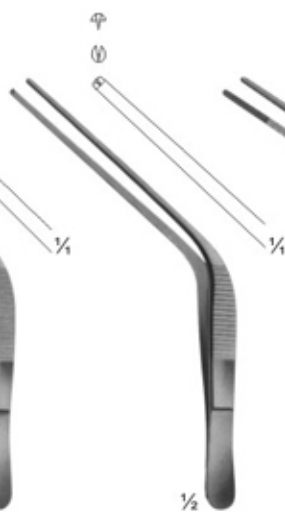

**04-239**  
TROELTSCH  
1X2 teeth  
115 mm

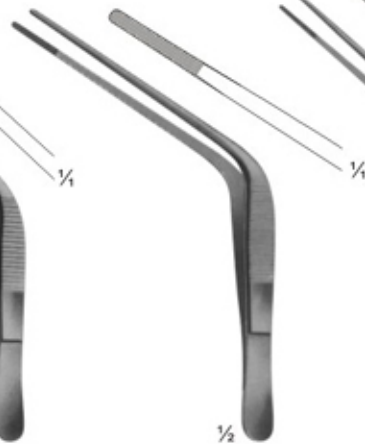

**04-240**  
WILDE  
115 mm

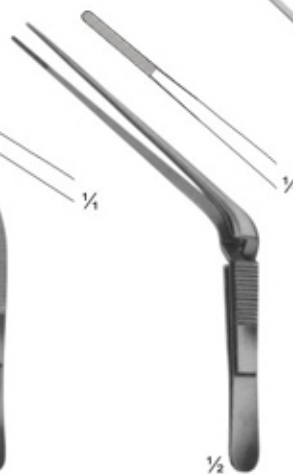

**04-241**  
TROELTSCH  
Cross action  
120 mm



**04-242**  
TROELTSCH  
140 mm



**Benodict**  
SURGICAL INSTRUMENTS

# Tissue Forceps, Lung Dissecting Forceps

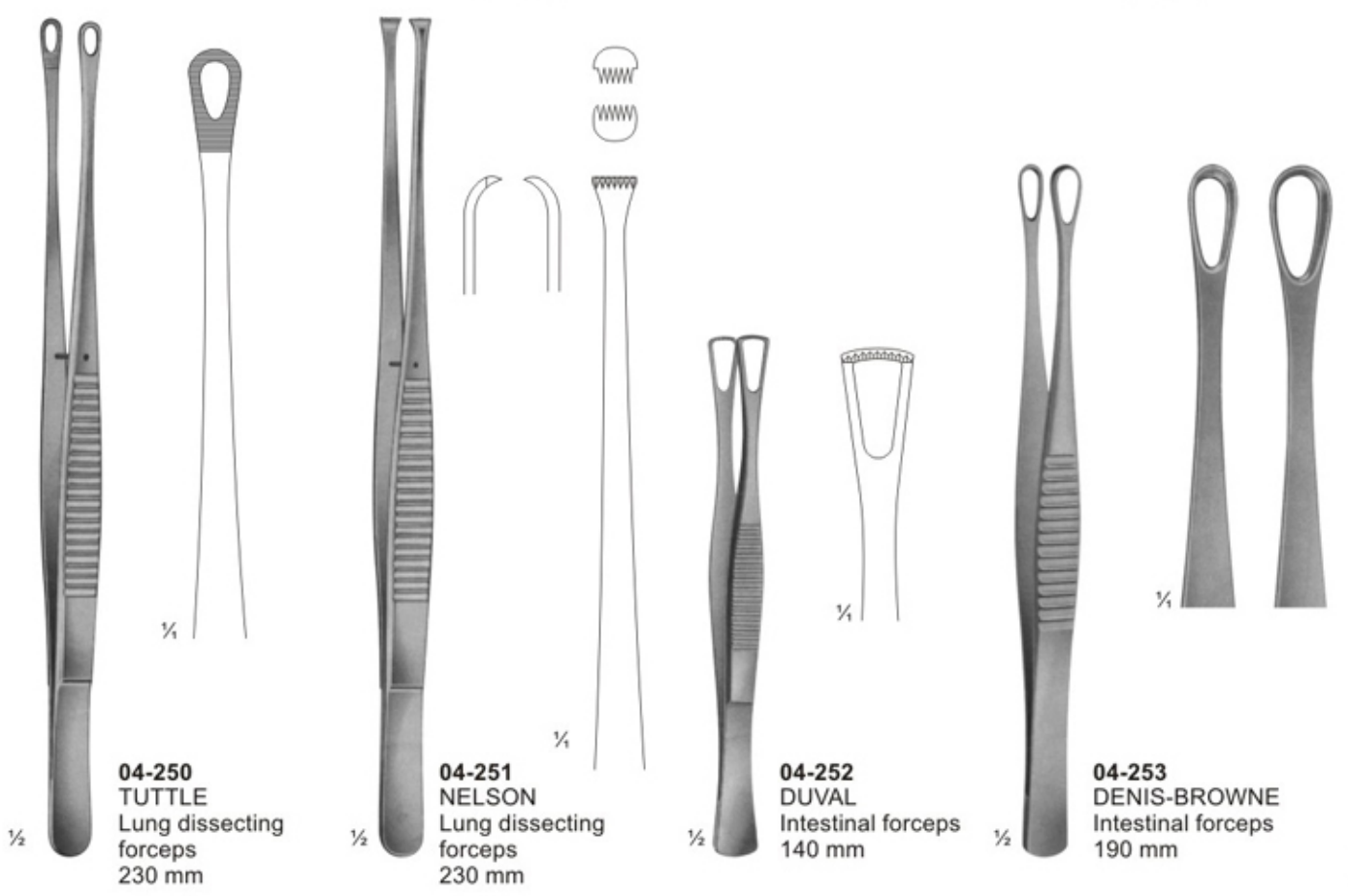
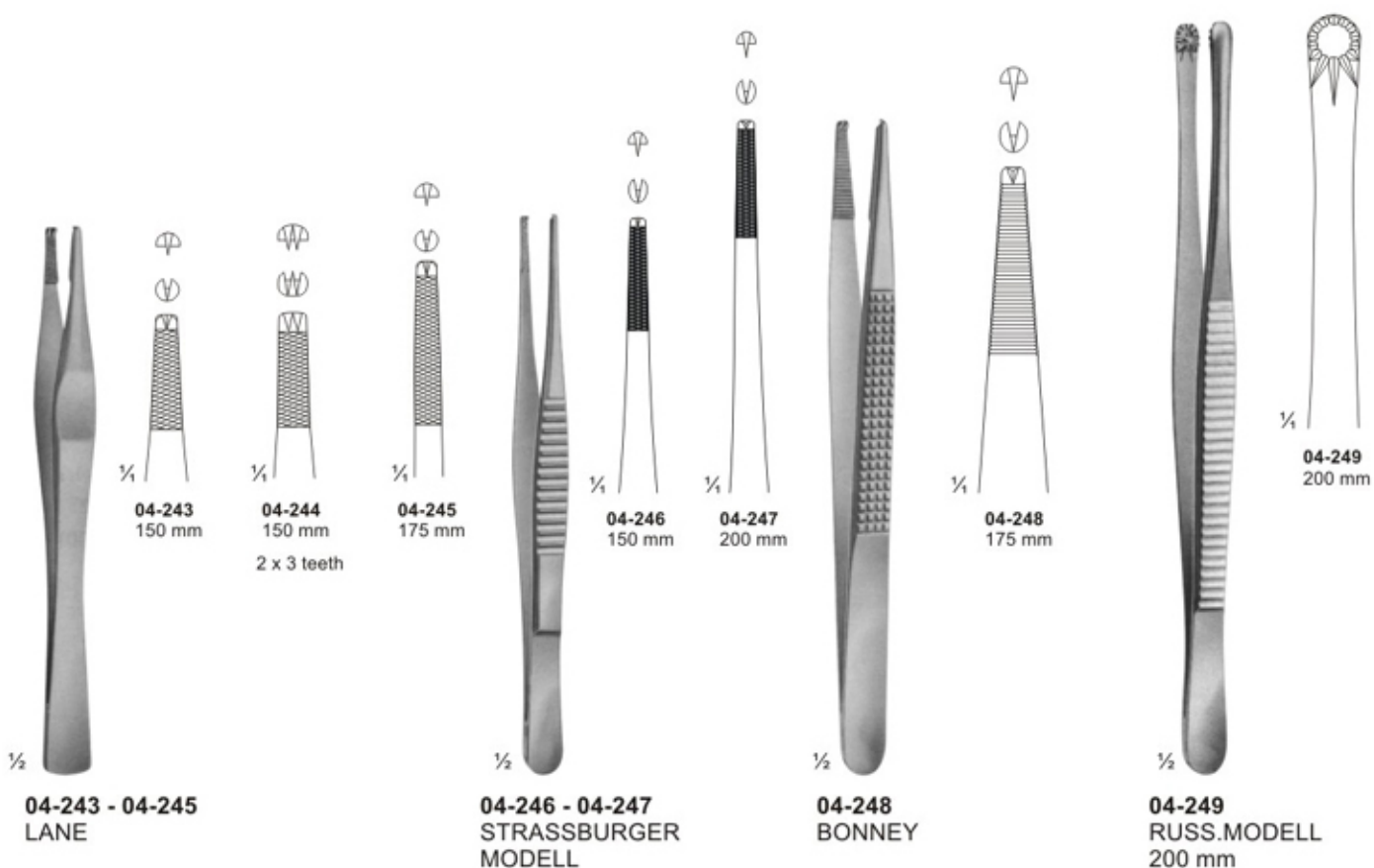





## Splinter and Cilia Forceps

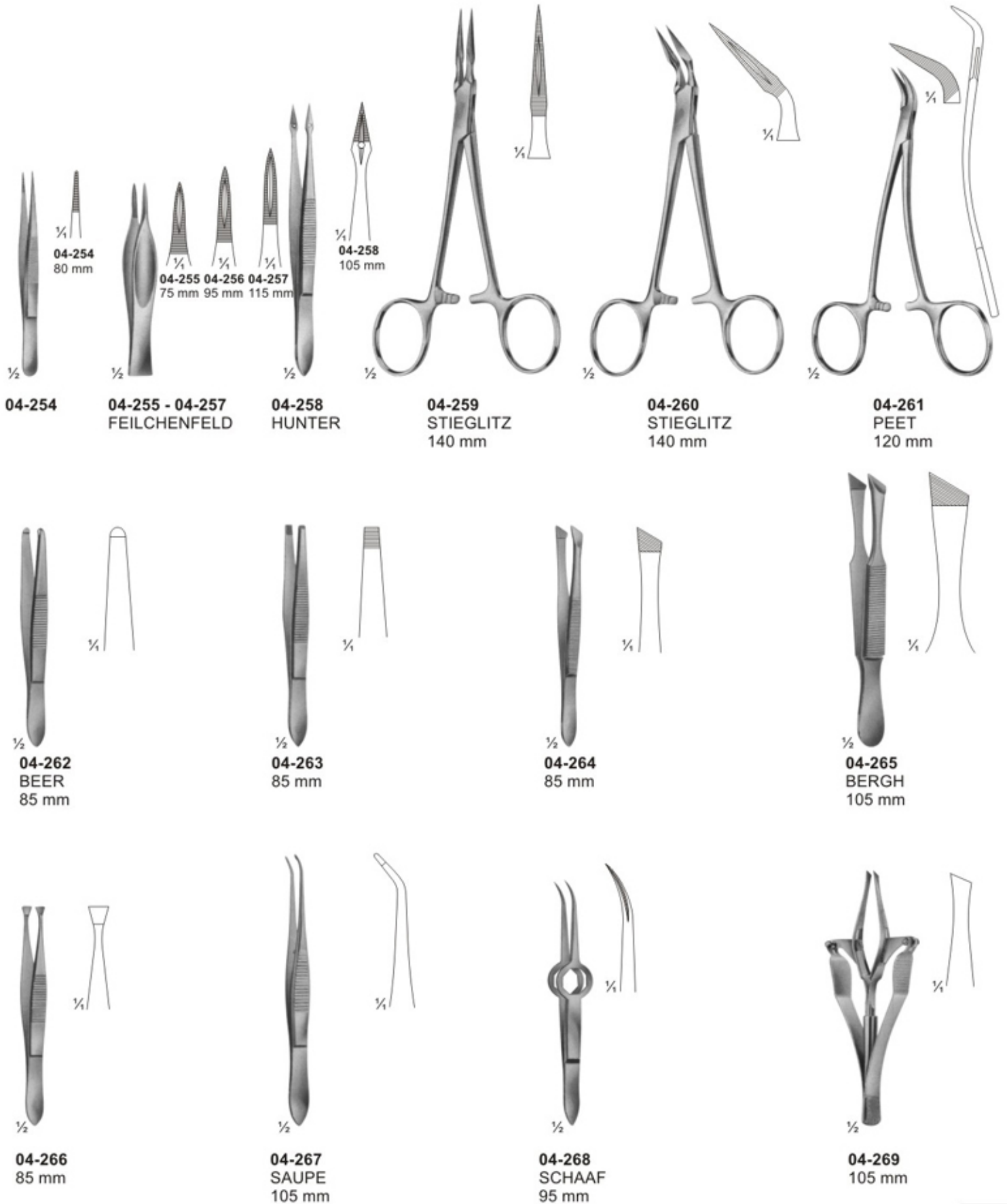

# Sponge and Dressing Forceps



**04-270**  
BRYANT  
130 mm

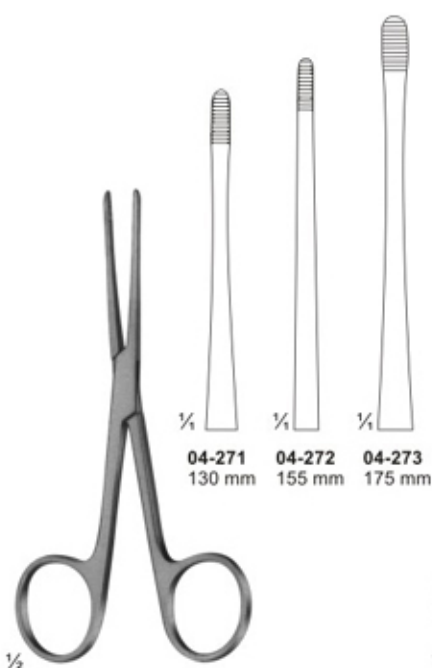

**04-271 - 04-273**  
LISTER  
Sinus forceps

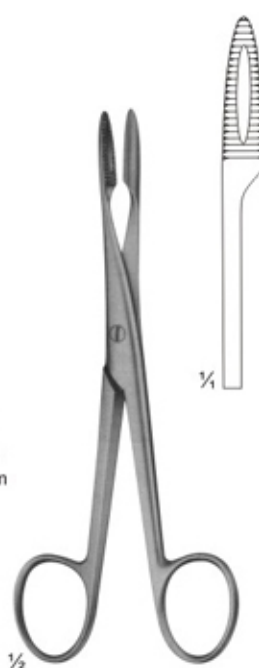

**04-274**  
without ratchet  
145 mm

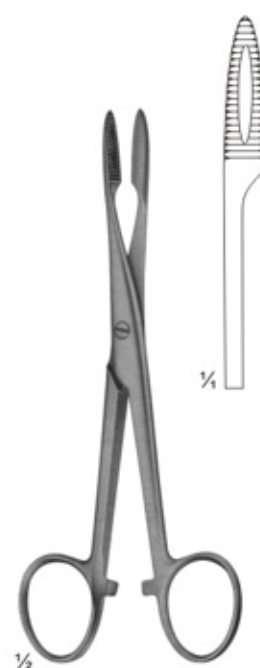

**04-275**  
with ratchet  
145 mm

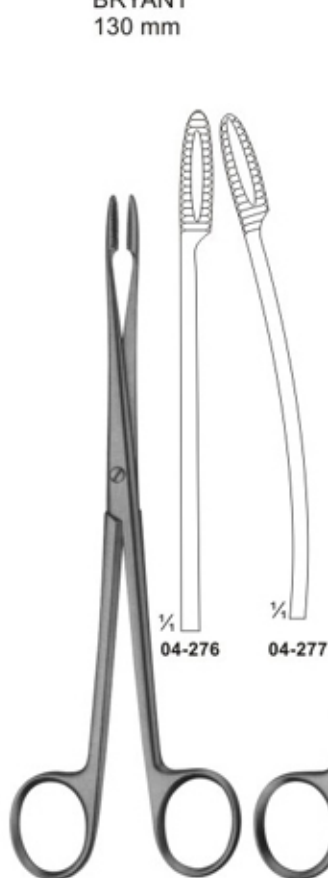

**04-276 - 04-277**  
GROSS  
without ratchet  
180 mm

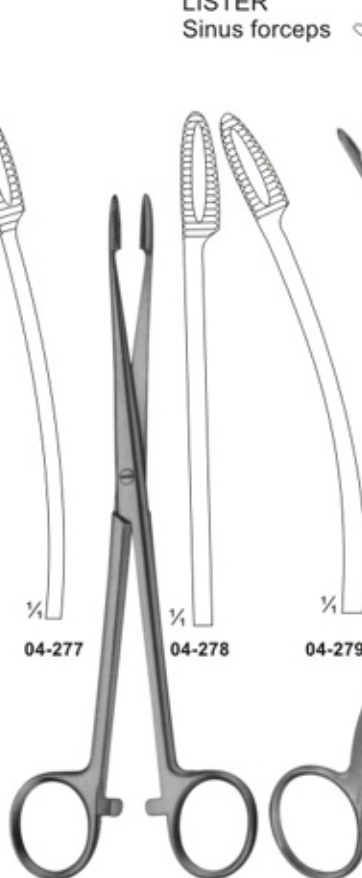

**04-278 - 04-279**  
GROSS  
with ratchet  
180 mm

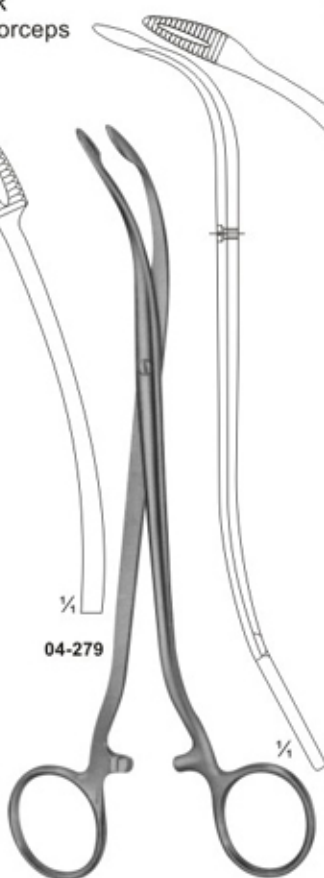

**04-280**  
DUPLAY  
190 mm

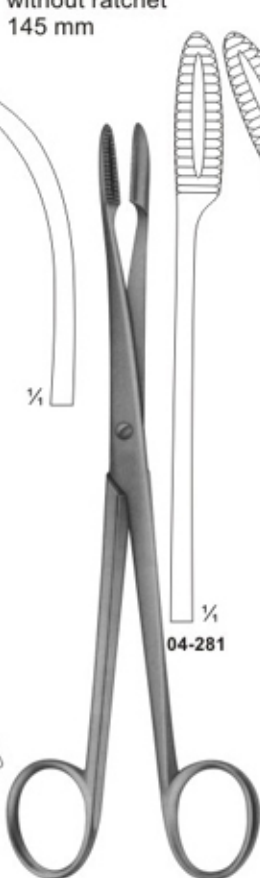

**04-281 - 04-282**  
GROSS  
without ratchet  
200 mm

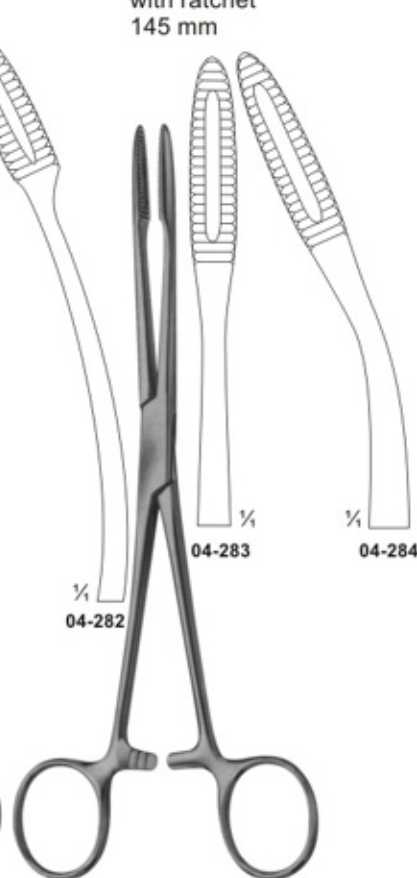

**04-283 - 04-284**  
GROSS  
200 mm



**Dressing-, Sponge holding-, Organ- and Tissue Grasping Forceps**

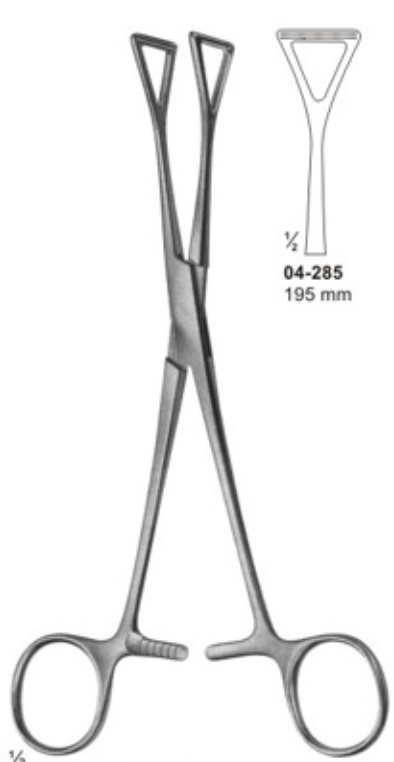

**04-285 - 04-286**  
COLLIN

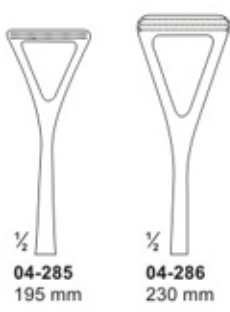

$\frac{1}{2}$   
**04-285**  
195 mm

$\frac{1}{2}$   
**04-286**  
230 mm

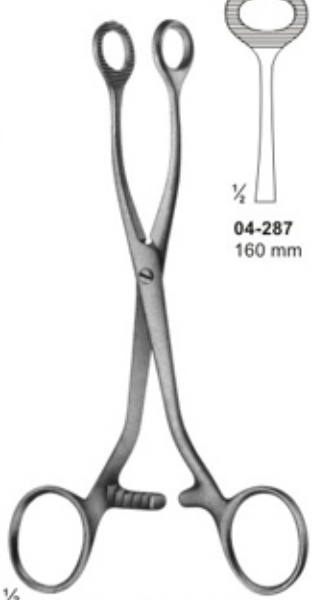

**04-287 - 04-289**  
COLLIN

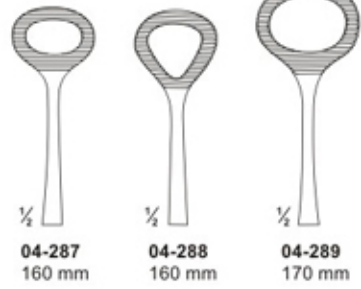

$\frac{1}{2}$   
**04-287**  
160 mm

$\frac{1}{2}$   
**04-288**  
160 mm

$\frac{1}{2}$   
**04-289**  
170 mm

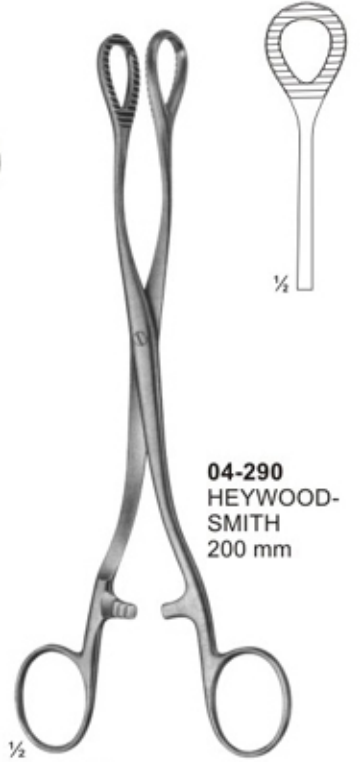

**04-290**  
HEYWOOD-SMITH  
200 mm

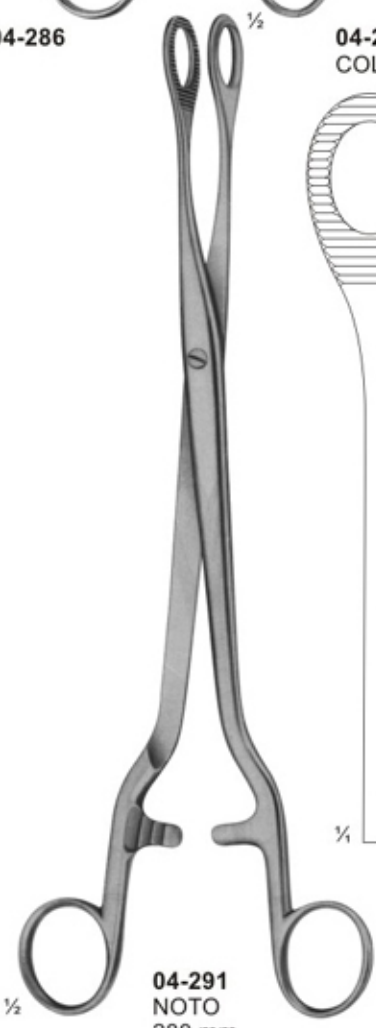

$\frac{1}{2}$   
**04-291**  
NOTO  
280 mm

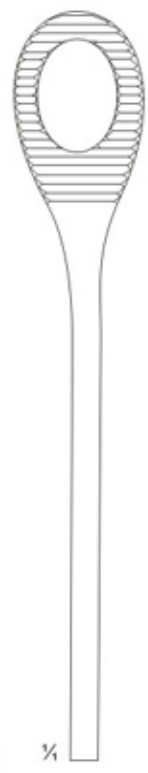

$\frac{1}{4}$

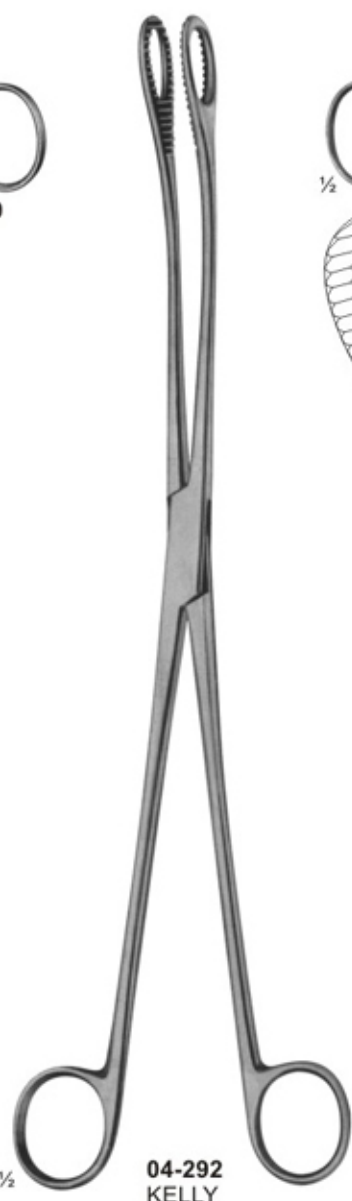

$\frac{1}{2}$   
**04-292**  
KELLY  
320 mm



$\frac{1}{4}$



**Benodict**  
SURGICAL INSTRUMENTS

# Dressing, Sponge holding, Organ and Tissue Grasping Forceps

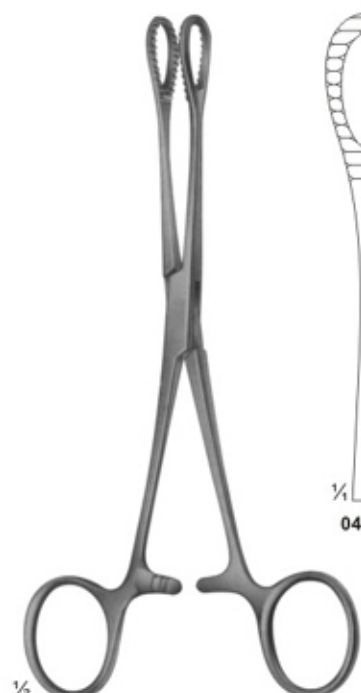

04-293



04-294

1/2  
**04-293 - 04-294**  
FOERSTER-BALLENGER  
180 mm



04-295  
180 mm



04-296  
250 mm

1/2  
**04-295 - 04-296**  
RAMPLEY



04-297  
Smooth Jaws



04-298  
Smooth Jaws



04-299  
Serrated Jaws



04-300  
Serrated Jaws

1/2  
**04-297 - 04-300**  
FOERSTER-BALLENGER  
240 mm

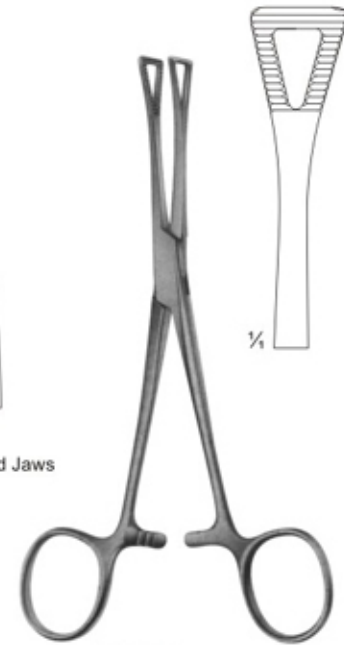

1/4

**04-301**  
PENNINGTON  
155 mm





# Intestinal Grasping Forceps

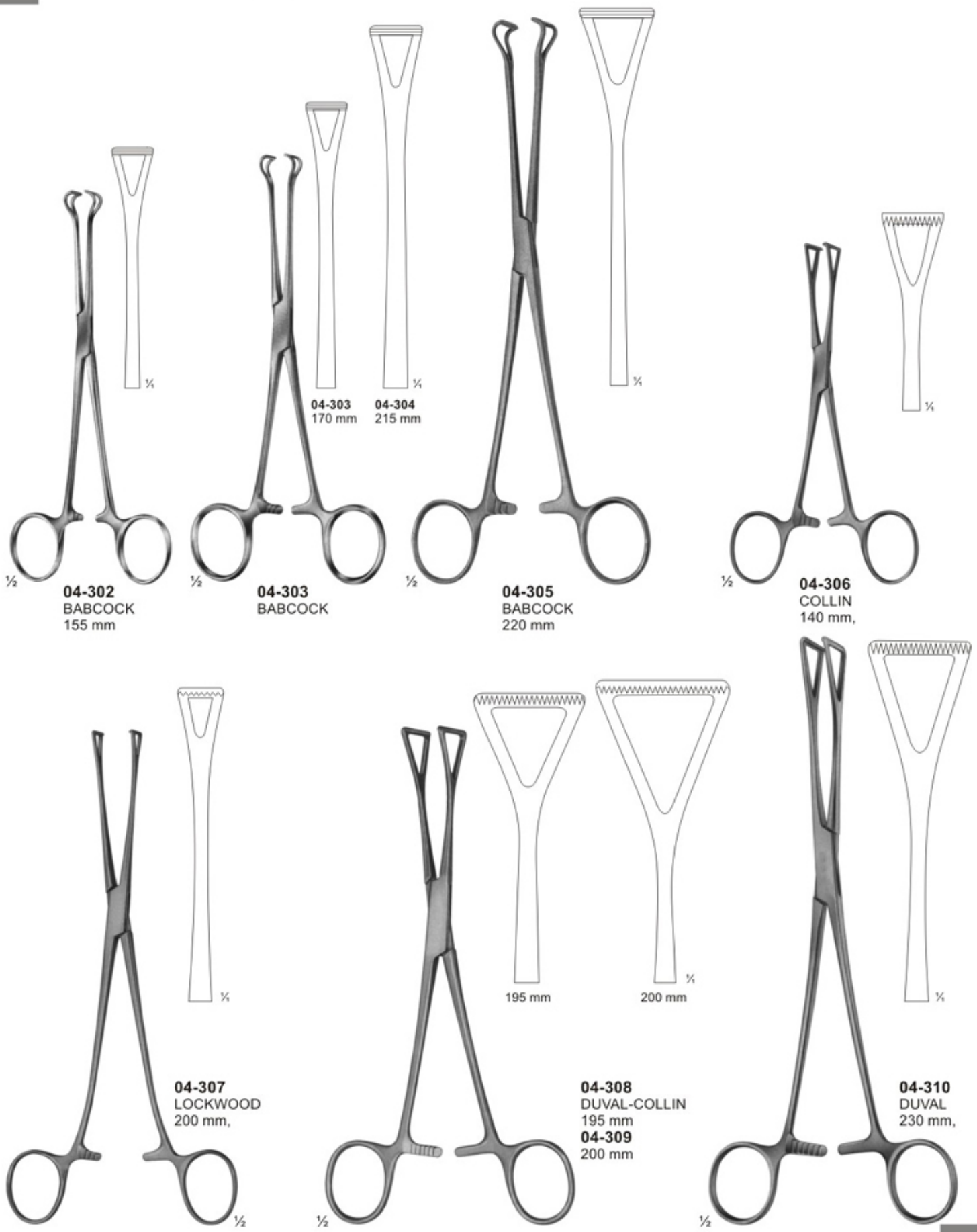

## Artery Traction - and Tissue Grasping Forceps

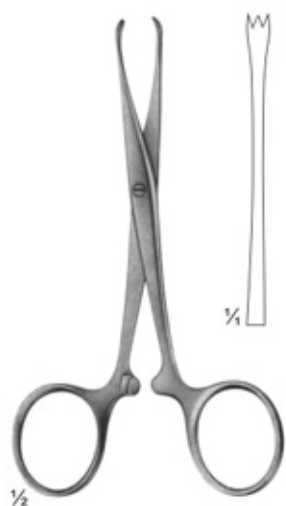

**04-311**  
CHAPUT  
2 x 3 teeth  
125 mm

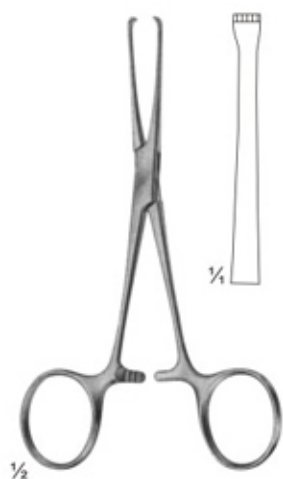

**04-312**  
BABY-ALLIS  
4 x 5 teeth  
130 mm

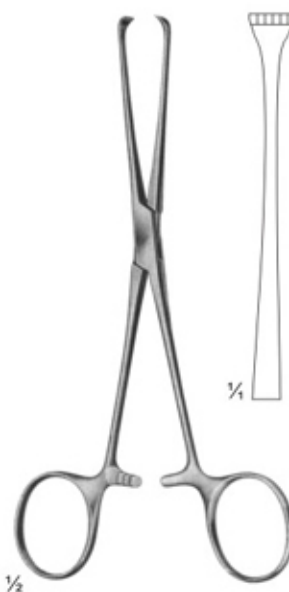

**04-313**  
BOYS-ALLIS  
5 x 6 teeth sharp  
155 mm

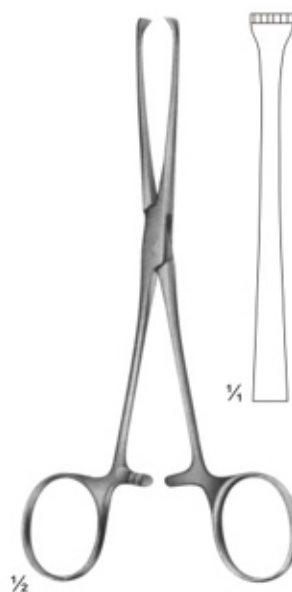

**04-314**  
ALLIS  
5 x 6 teeth  
155 mm



**04-315**  
LAHEY  
155 mm

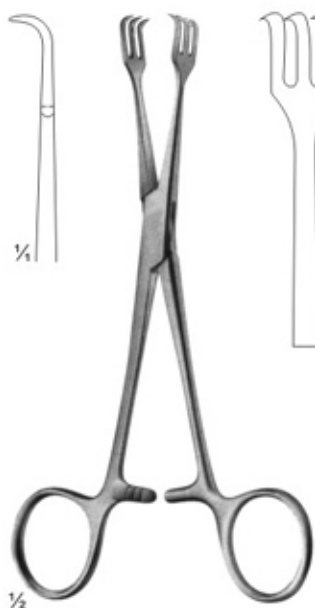

**04-316**  
LAHEY  
155 mm

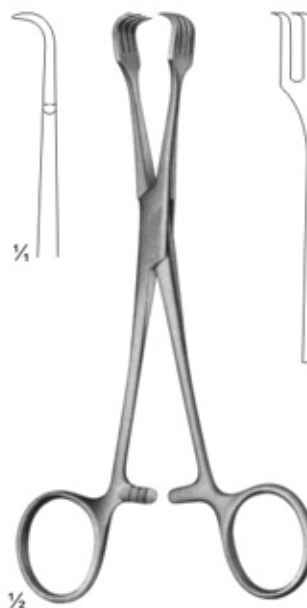

**04-317**  
BRAUN  
155 mm

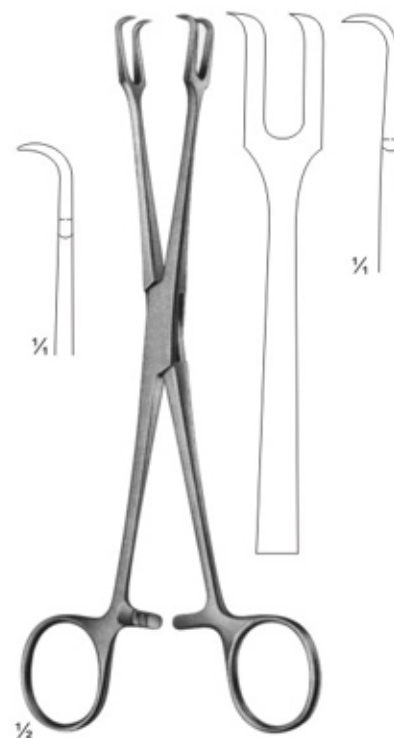

**04-318**  
MUSEUX  
200 mm

# Towel Clamps

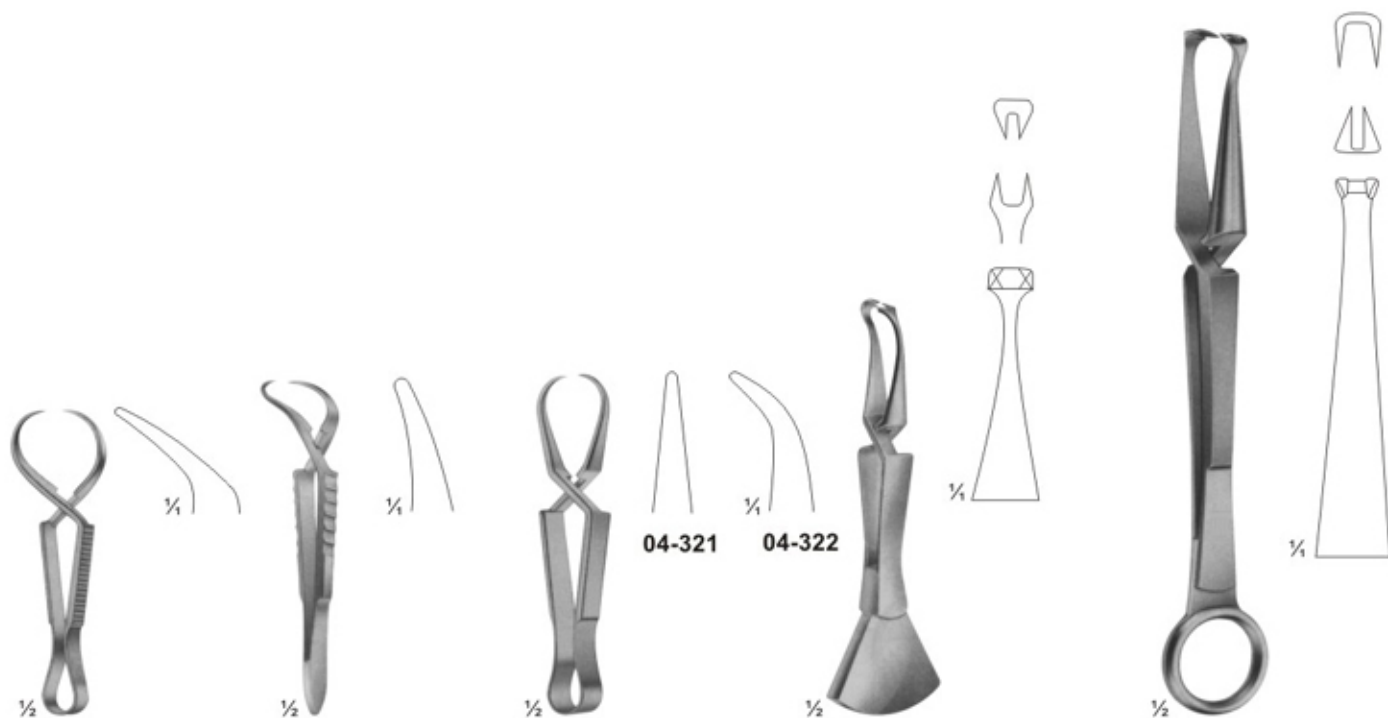

**04-319**  
JONES  
85 mm

**04-320**  
ENGL. MOD.  
85 mm

**04-321 - 04-322**  
SCHAEDEL  
85 mm

**04-323**  
DOYEN  
110 mm

**04-324**  
DOYEN  
180 mm

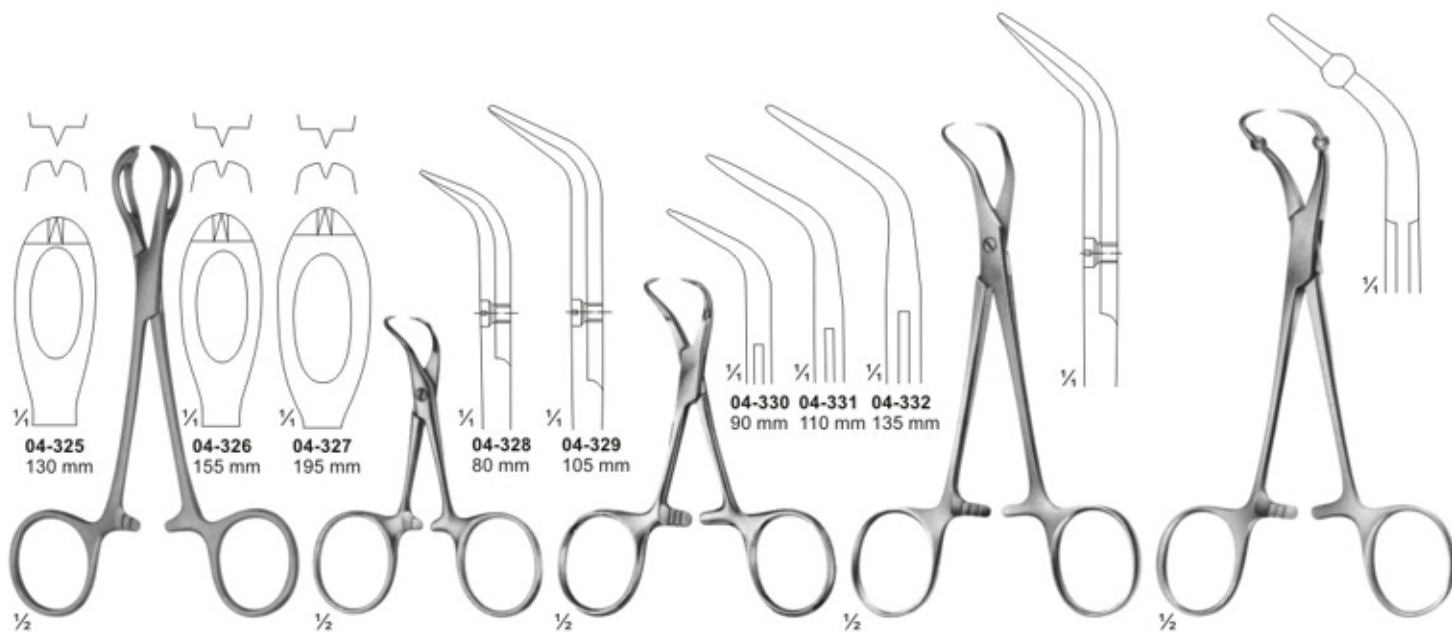

**04-325**  
130 mm

**04-326**  
155 mm

**04-327**  
195 mm

**04-328**  
80 mm

**04-329**  
105 mm

**04-330 04-331 04-332**  
90 mm 110 mm 135 mm

**04-325 - 04-327**  
LANE

**04-328 - 04-329**  
BACKHAUS

**04-330 - 04-332**  
BACKHAUS

**04-333**  
BACKHAUS-KOCHER  
135 mm

**04-334**  
ROEDER  
135 mm



# Muller Vessel Clips and Bulldog Clamps

## Closing force



**04-335**  
straight



**04-336**  
curved



**04-337**  
curved tips



**04-338**  
angled shaped



**04-339**  
MULLER  
knee-bent



**04-340**  
Muller  
Ligature Forceps



**04-351**  
straight



**04-352**  
curved



**04-353**  
curved tips



**04-354**  
angled shaped



**04-355**  
MULLER  
knee-bent



**04-356**  
Muller  
Ligature Forceps



Jaw, cross serrated



**04-341**  
35 mm



**04-342**  
35 mm



**04-343**  
45 mm



**04-344**  
45 mm



DIEFFENBACH

**04-345**  
38 mm



DIEFFENBACH

**04-346**  
48 mm



DIEFFENBACH

**04-347**  
58 mm



DIEFFENBACH

**04-348**  
58 mm



DIEFFENBACH

**04-349**  
91 mm



DIEFFENBACH

**04-350**  
20 mm

- 04-351** 38 mm
- 04-352** 48 mm
- 04-353** 56 mm
- 04-354** 63 mm
- 04-355** 70 mm
- 04-356** 80 mm
- 04-357** 91 mm



**04-359**  
length 50 mm  
jaws 27 mm



**04-360**  
length 48 mm  
jaws 27 mm



**04-361**  
GLOVER  
length 57 mm  
jaws 35 mm



**04-362**  
DE BAKEY  
length 73 mm  
jaws 38 mm



**04-363**  
DE BAKEY  
length 99 mm  
jaws 63 mm



**04-364**  
DE BAKEY  
length 95 mm  
jaws 54 mm



**04-365**  
DE BAKEY  
L. 80 mm



**04-366**  
DE BAKEY  
L. 90 mm



**04-367**  
DE BAKEY  
L. 105 mm



**04-368**  
DE BAKEY  
L. 124 mm



**04-369**  
DE BAKEY  
L. 78 mm



**04-370**  
DE BAKEY  
L. 86 mm

**04-371**  
L. 97 mm

**04-372**  
L. 117 mm

**04-373**  
GLOVER  
L. 68 mm

**04-374**  
L. 96 mm

**04-375**  
L. 117 mm

**04-376**  
GLOVER  
L. 65 mm

**04-377**  
L. 91 mm

**04-378**  
L. 110 mm





**Benodict**  
SURGICAL INSTRUMENTS

## Delicate Haemostatic Forceps

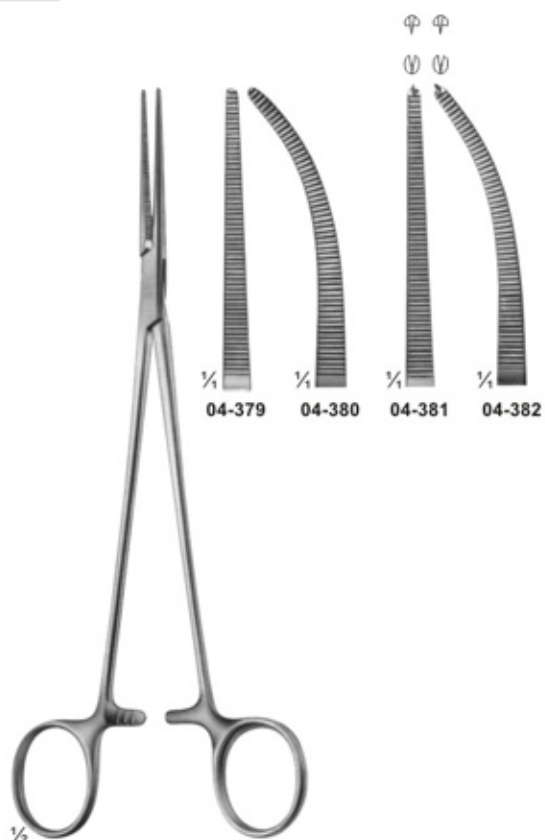

**04-379 - 04-382**  
HALSTED-MOSQUITO  
200 mm

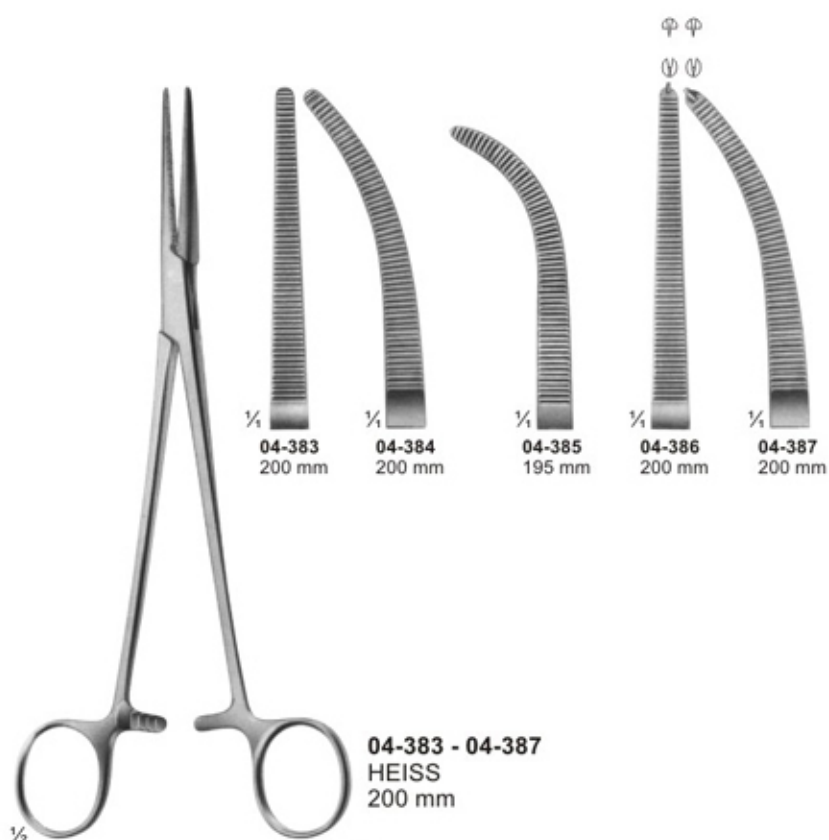

**04-383 - 04-387**  
HEISS  
200 mm

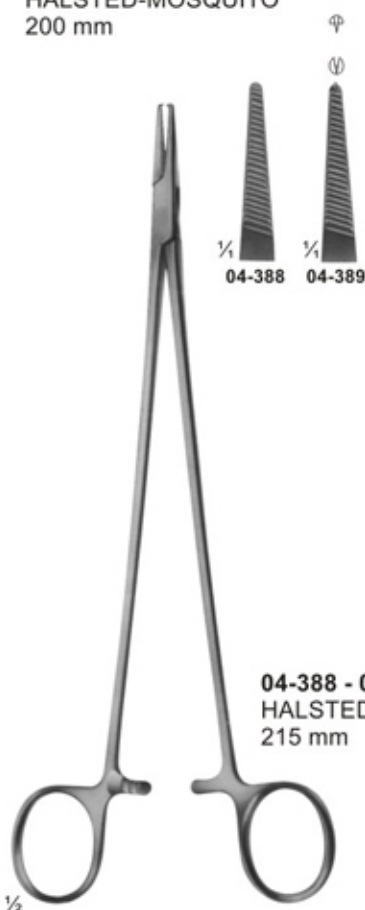

**04-388 - 04-389**  
HALSTED  
215 mm

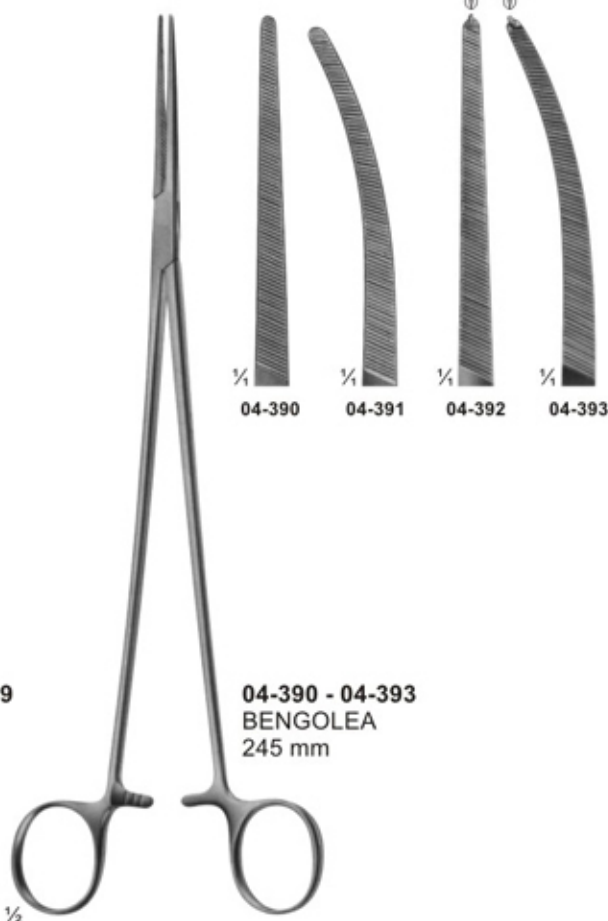

**04-390 - 04-393**  
BENGOLEA  
245 mm

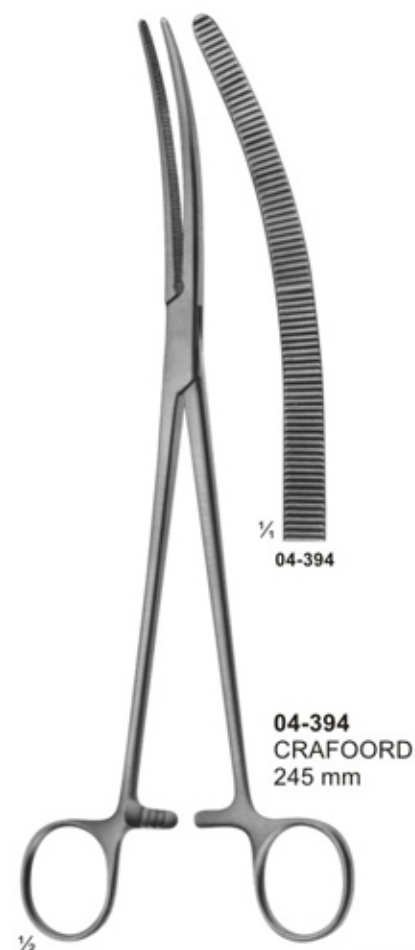

**04-394**  
CRAFOORD  
245 mm



**Benodict**  
SURGICAL INSTRUMENTS

# Delicate Haemostatic Forceps



**04-395**  
CARREL  
85 mm



**04-396 - 04-399**  
BABY-MOSQUITO  
(HARTMANN)  
100 mm

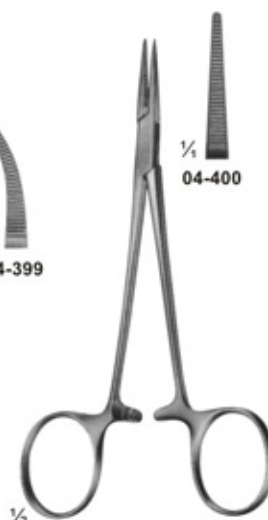
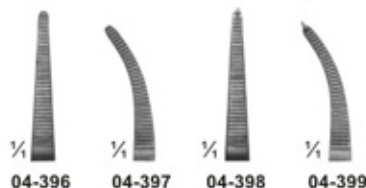

**04-400 - 04-403**  
MICRO-HALSTED  
125 mm

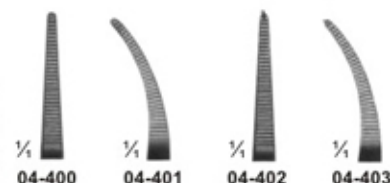

**04-404 - 04-407**  
HALSTED-MOSQUITO  
125 mm

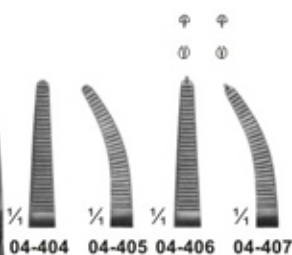

**04-408 - 04-409**  
PROVIDENCE-HOSPITAL  
140 mm

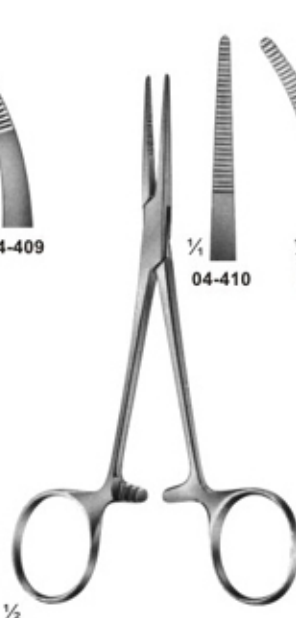

**04-410 - 04-411**  
KELLY  
140 mm

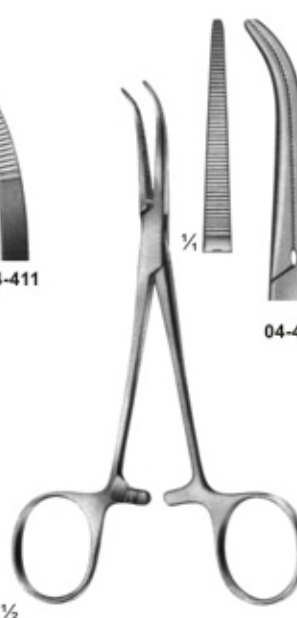

**04-412 - 04-413**  
DANDY  
Curved sideways  
140 mm

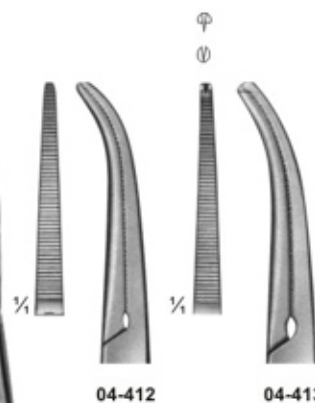



**Benodict**  
SURGICAL INSTRUMENTS

# Delicate Haemostatic Forceps

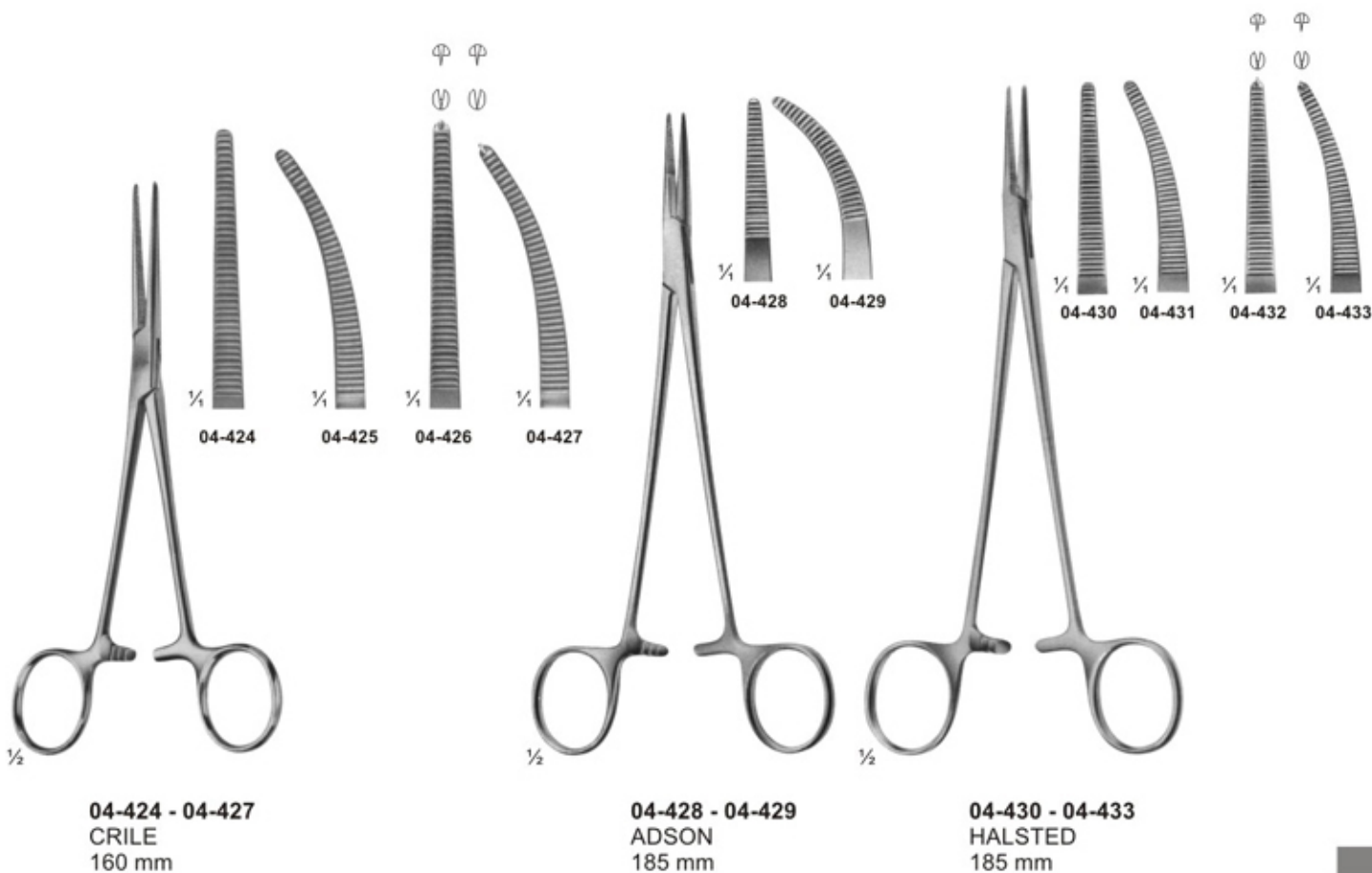
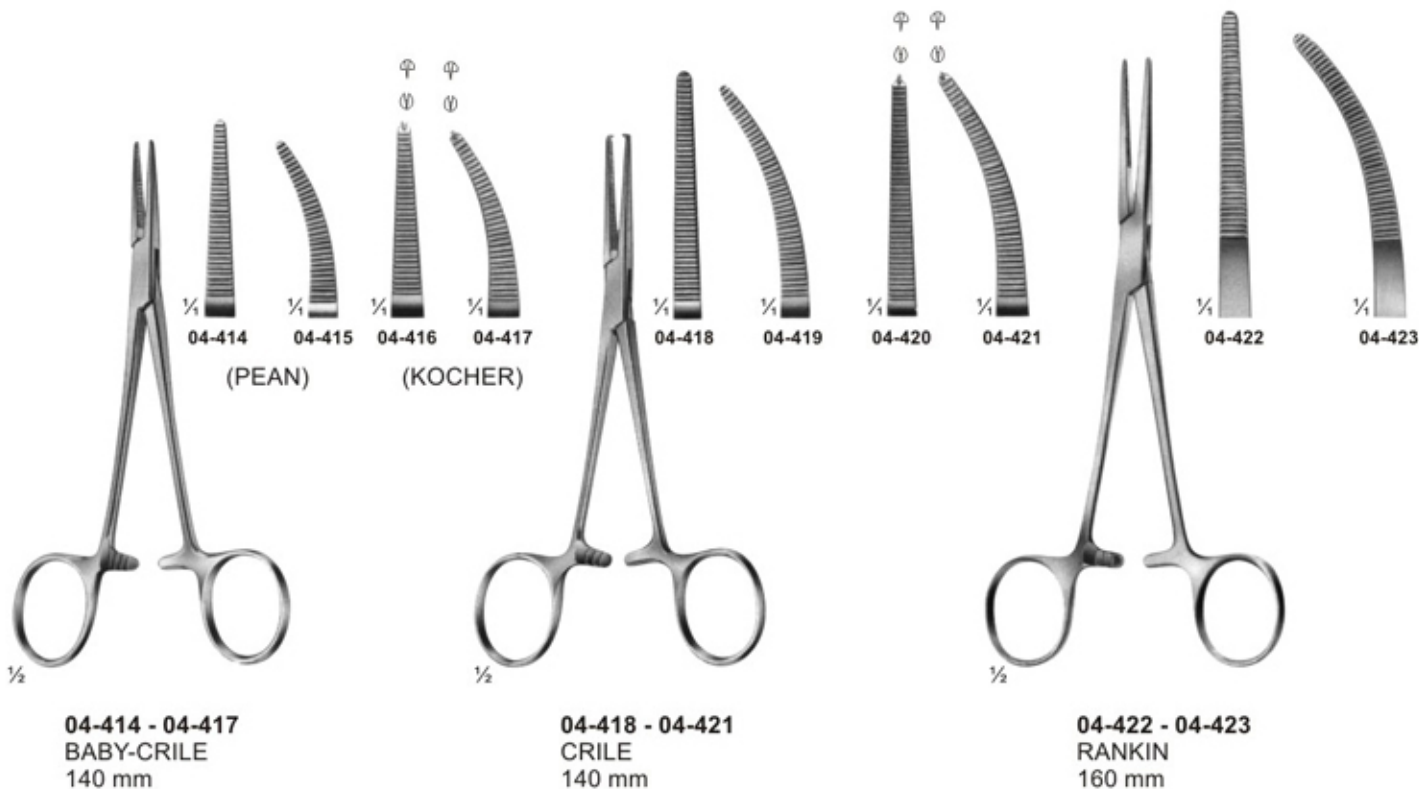



**Benodict**  
SURGICAL INSTRUMENTS

## Haemostatic Forceps



04-434 130 mm  
04-435 140 mm  
04-436 130 mm  
04-437 140 mm

04-438 130 mm  
04-439 150 mm  
04-440 175 mm  
04-441 200 mm  
04-442 130 mm  
04-443 150 mm  
04-444 175 mm  
04-445 200 mm

**04-434 - 04-437**  
PEAN  
Slender type

**04-438 - 04-445**  
SPENCER-WELLS  
Slender type

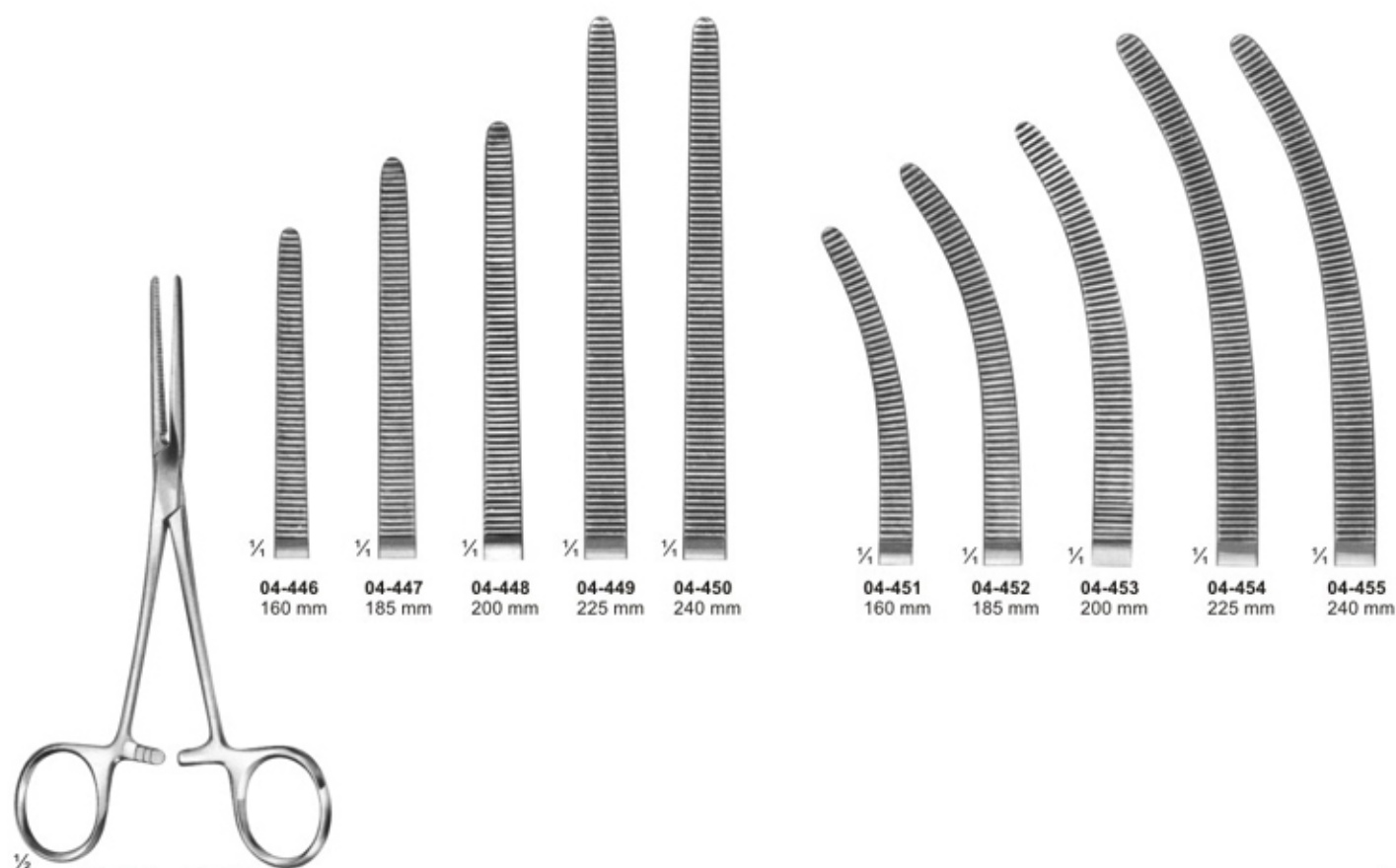

04-446 160 mm  
04-447 185 mm  
04-448 200 mm  
04-449 225 mm  
04-450 240 mm

04-451 160 mm  
04-452 185 mm  
04-453 200 mm  
04-454 225 mm  
04-455 240 mm

**04-446 - 04-455**  
ROCHESTER-PEAN





# Haemostatic Forceps



**04-456 - 04-461**  
PEAN

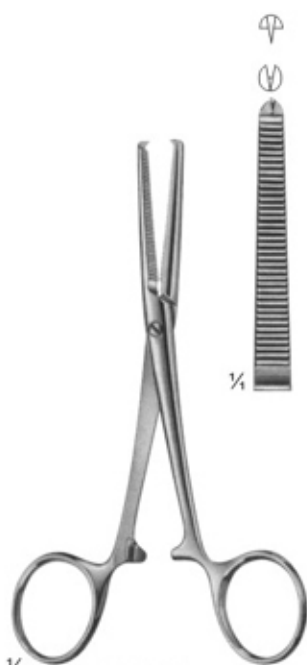
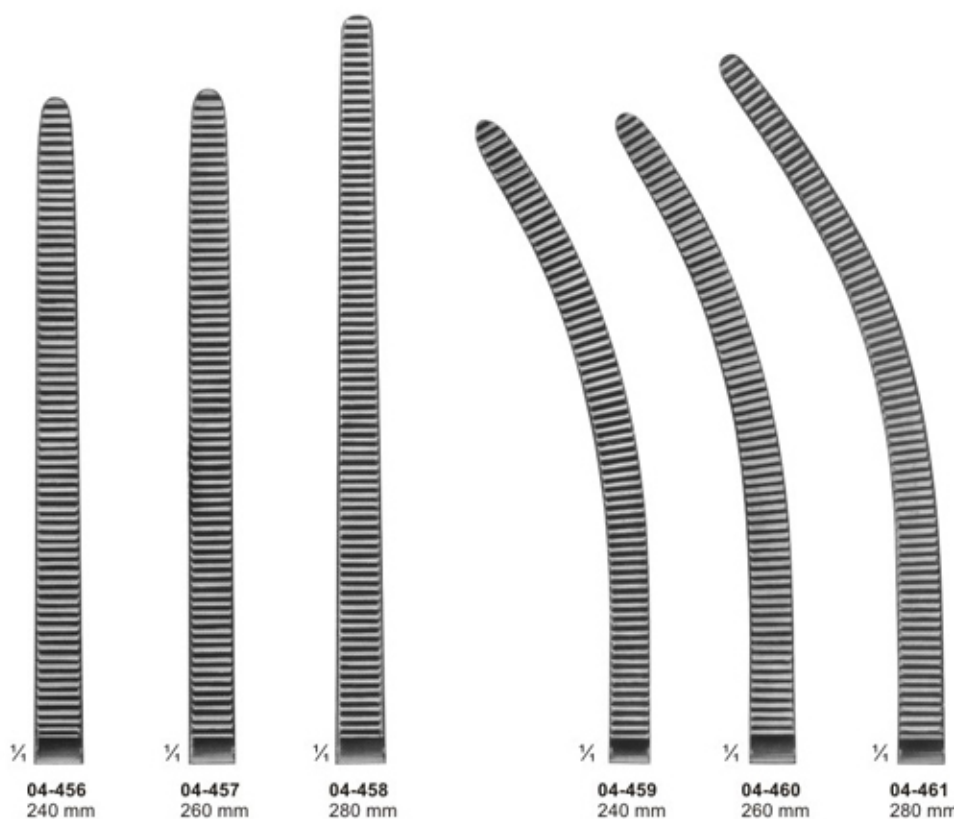

**04-462**  
KOCHER  
Strong Pattern  
145 mm

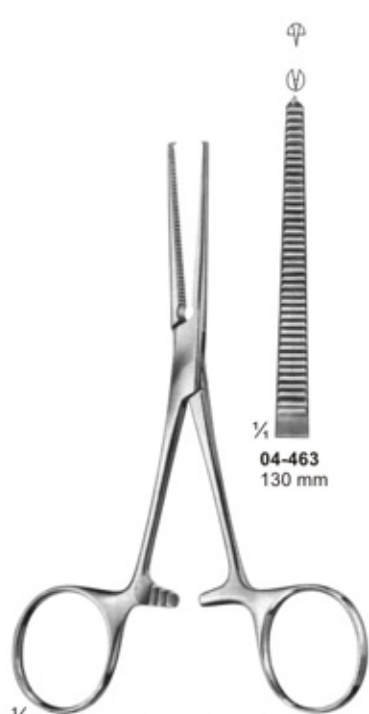

**04-463 - 04-465**  
KOCHER

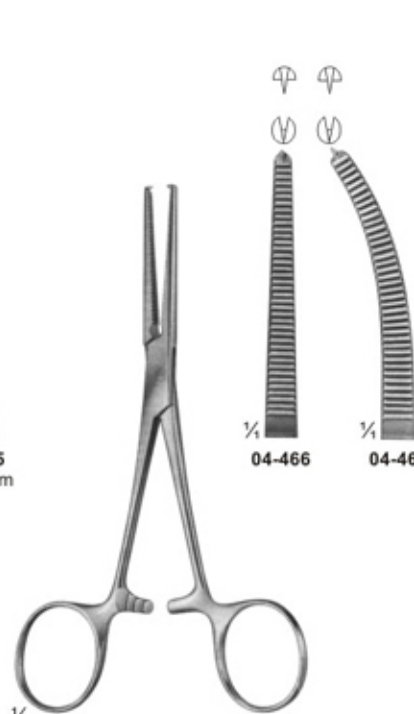
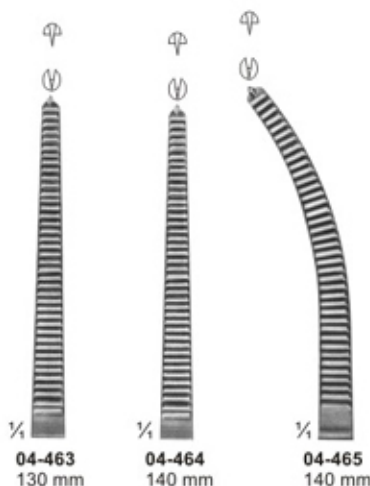

**04-466 - 04-467**  
ROCHESTER-OGHSNER  
140 mm

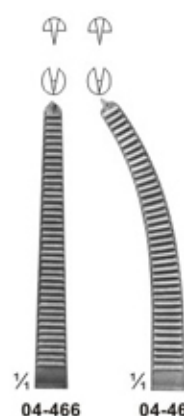



**Benodict**  
SURGICAL INSTRUMENTS

# Haemostatic Forceps

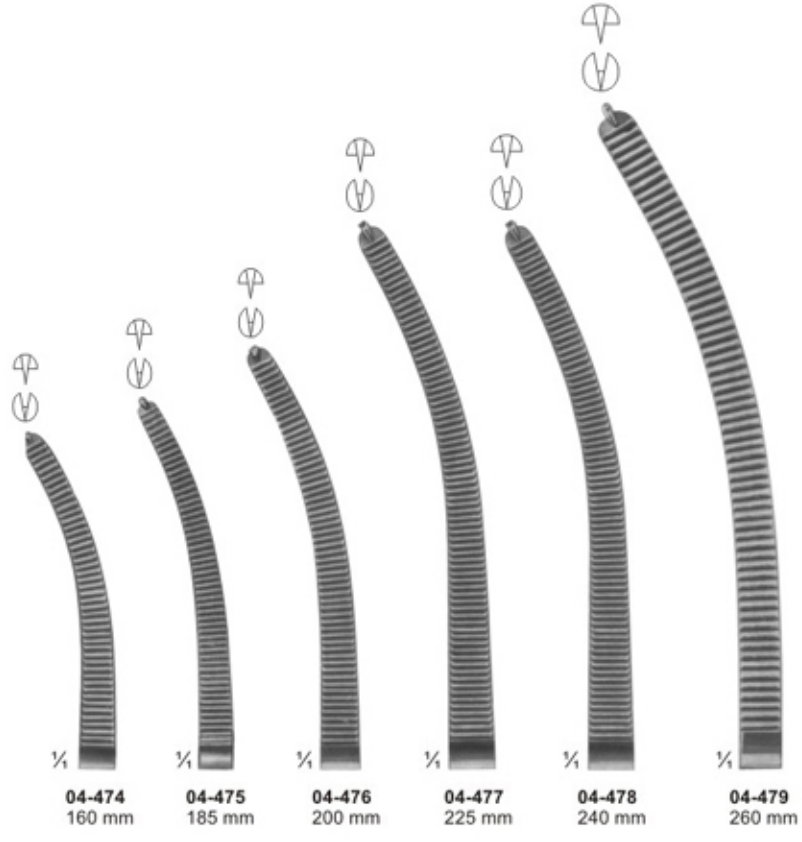
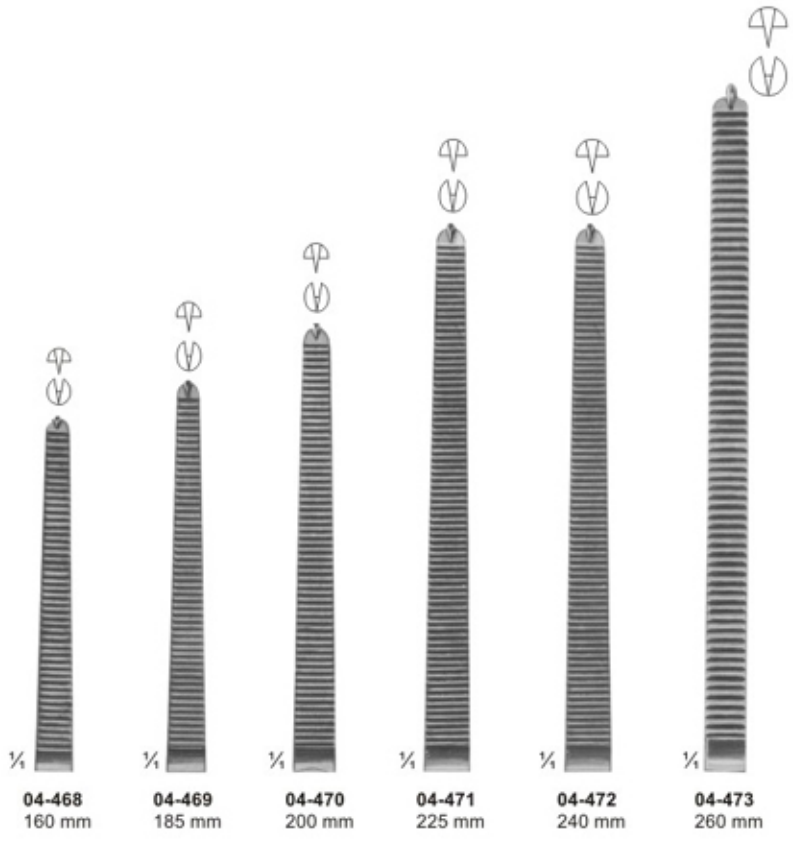

04-468 - 04-479  
KOCHER-OCHSNER

## Haemostatic Forceps

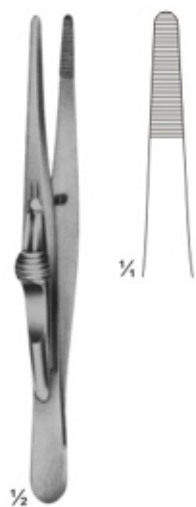

**04-480**  
FRICKE  
Artery forceps  
130 mm

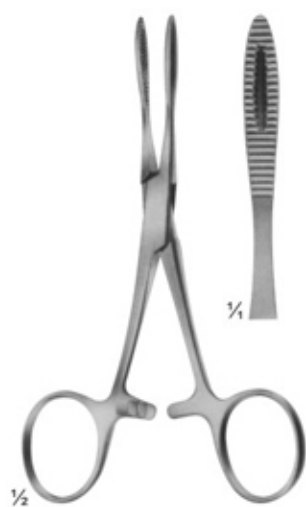

**04-481**  
KRONLEIN  
130 mm

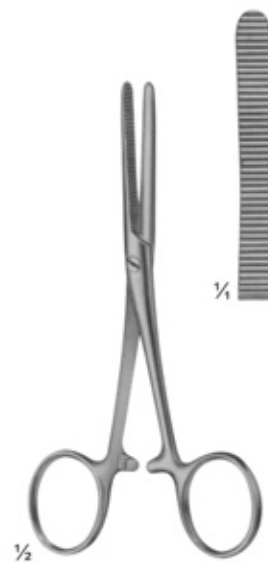

**04-482**  
PEAN  
125 mm



**04-483 - 04-484**  
PEAN



**04-484**  
140 mm

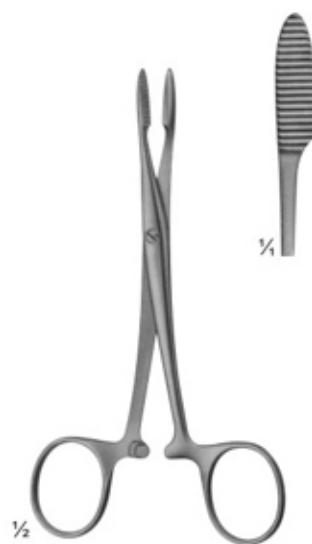

**04-485**  
PEAN  
125 mm



**04-486 - 04-487**  
PEAN

**04-486**  
165 mm

**04-487**  
185 mm



**Benodict**  
SURGICAL INSTRUMENTS

# Haemostatic Forceps, Special Pattern, Tonsil Forceps

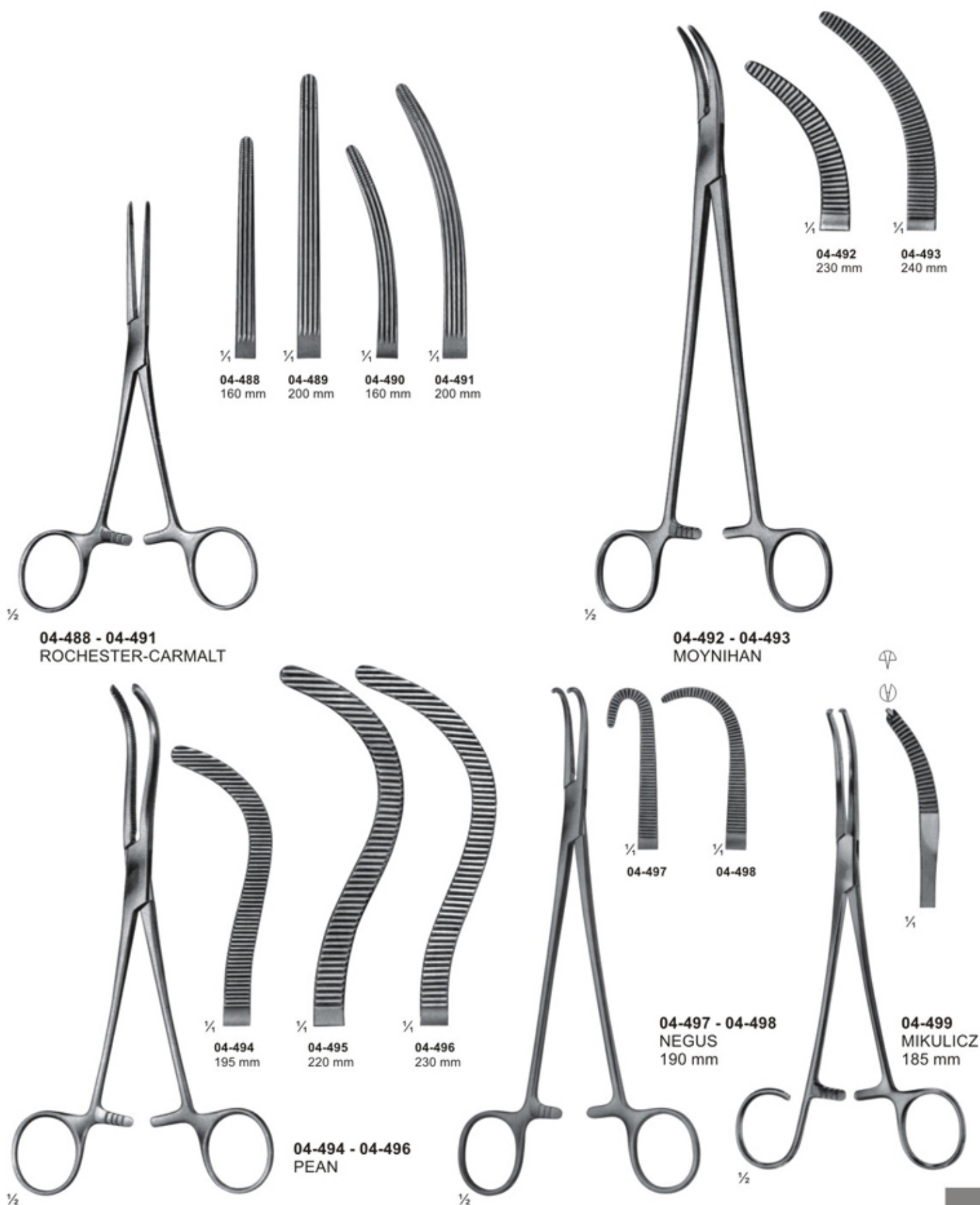





# Dissecting- and Ligature Forceps



**04-500**  
MIXTER-O'SHAUGHNESSY  
190 mm

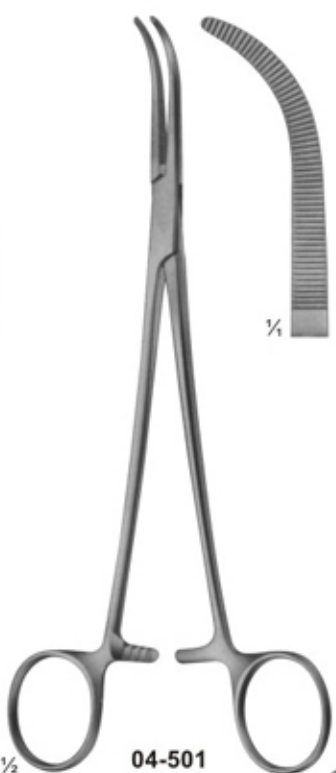

**04-501**  
HEISS  
195 mm

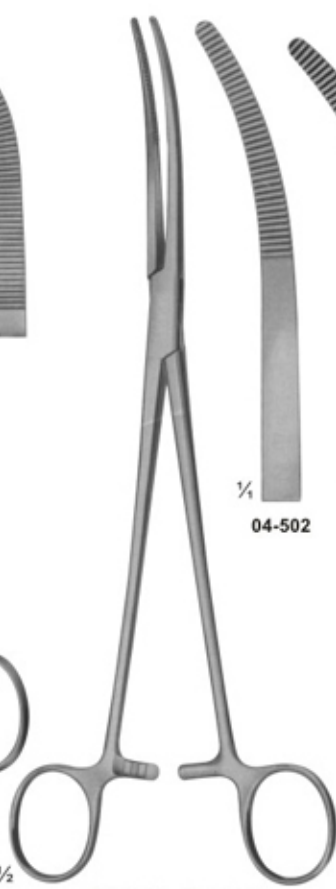

**04-502 - 04-506**  
RUMEL  
240 mm

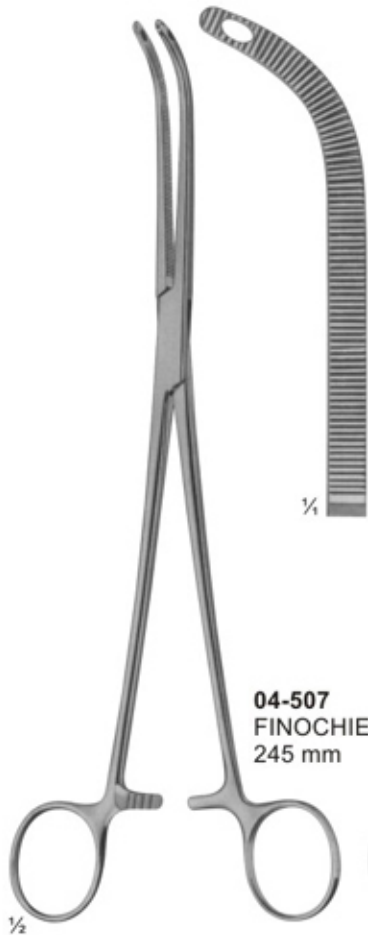
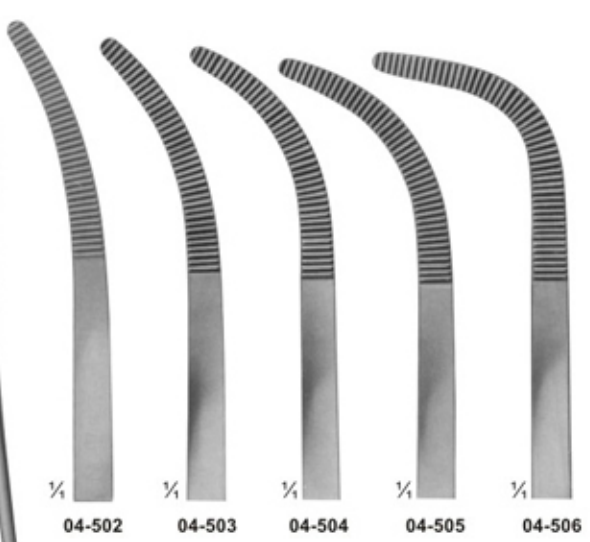

**04-507**  
FINOCHIETTO  
245 mm

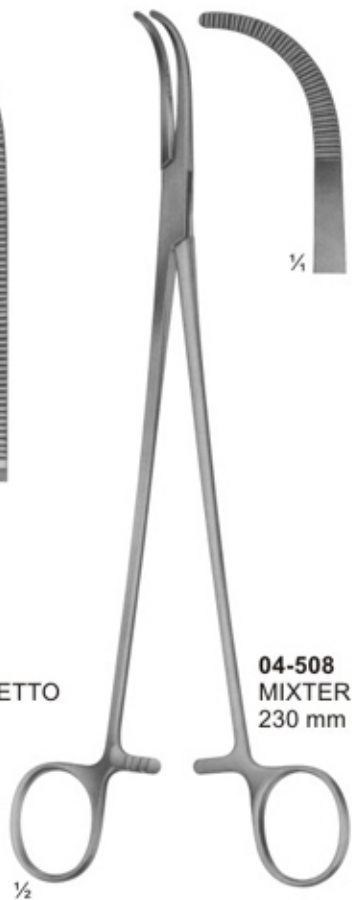

**04-508**  
MIXTER  
230 mm



**04-509**  
LAWRENCE  
270 mm

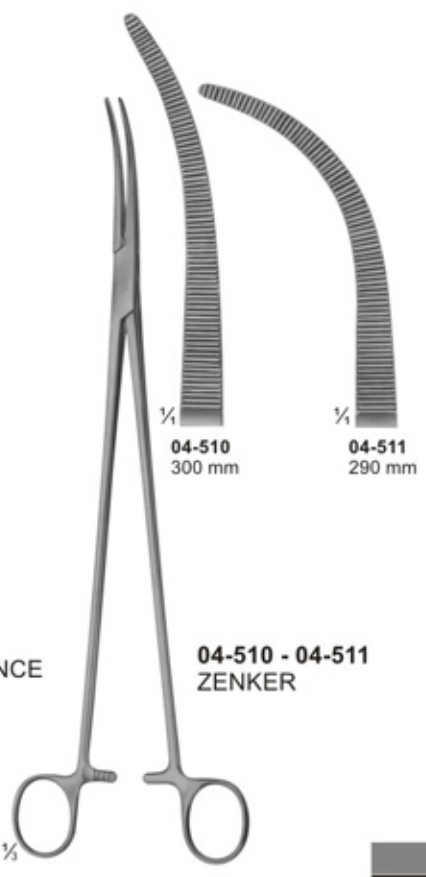

**04-510 - 04-511**  
ZENKER



**Benodict**  
SURGICAL INSTRUMENTS

# Hysterectomy Forceps, Vaginal Clamps and Compression Forceps



**04-512**  
WERTHEIM  
Hysterectomy forceps  
255 mm

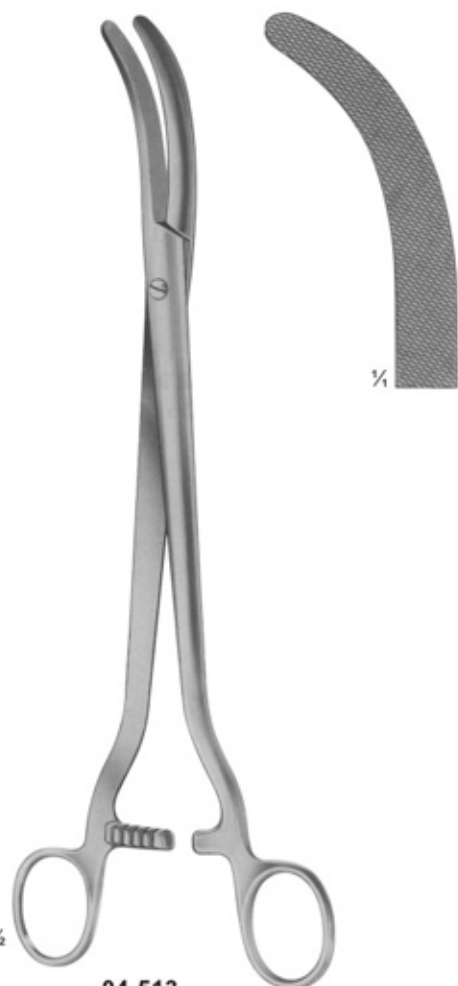

**04-513**  
WERTHEIM  
Parametrium clamp  
260 mm



**04-514 - 04-516**  
DICK

**04-514** 255 mm  
**04-515** 265 mm  
**04-516** 275 mm

**Hysterectomy Forceps, Vaginal Clamps  
and Compression Forceps**

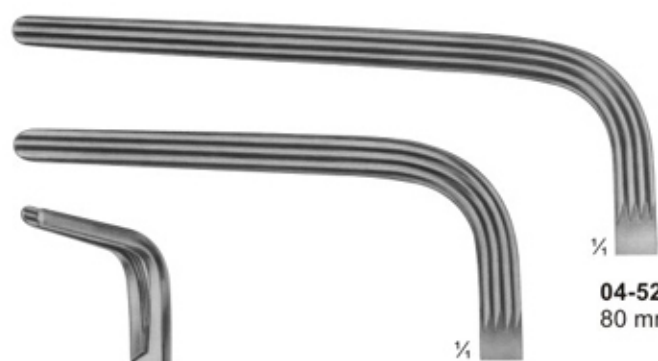



## Needle Holders for micro surgery



**05-101**  
ROHRSCHEIDER  
with copper inserts  
100 mm



**05-102**  
KALT  
with catch  
135 mm



**05-103**  
ARRUGA  
with catch  
135 mm



**05-104 - 105**  
CASTROVIEJO  
with catch  
145 mm



**05-106 - 107**  
without Catch  
160 mm



**05-108 - 109**  
without catch  
185 mm

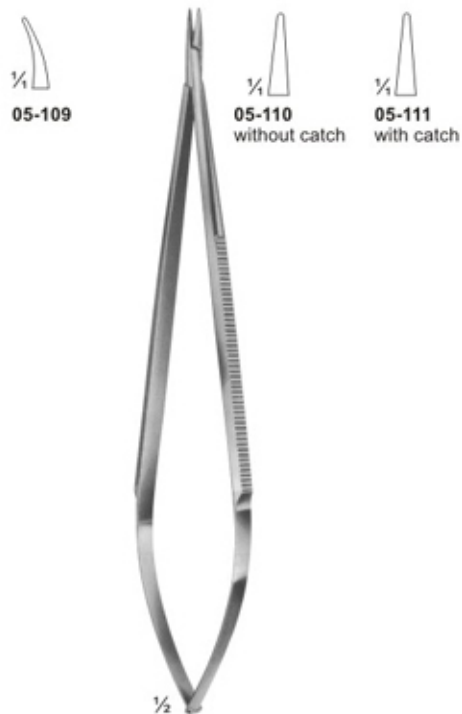

**05-110 - 111**  
JACOBSON  
185 mm



**05-112**  
without catch  
195 mm



**05-113 - 114**  
YASARGIL  
with catch  
200 mm





# Needle Holders



**05-115 - 117**  
MAYO-HEGAR  
medium fine patterns

**05-118 - 121**  
HEGAR  
heavy patterns

**05-122**  
HEANEY (HEGAR)  
200 mm



**05-123**  
JAMESON  
230 mm

**05-124**  
WANGENSTEEN  
275 mm

**05-125**  
MASSON  
265 mm

**05-126**  
MASSON-LUETHY  
255 mm

## Needle Holders

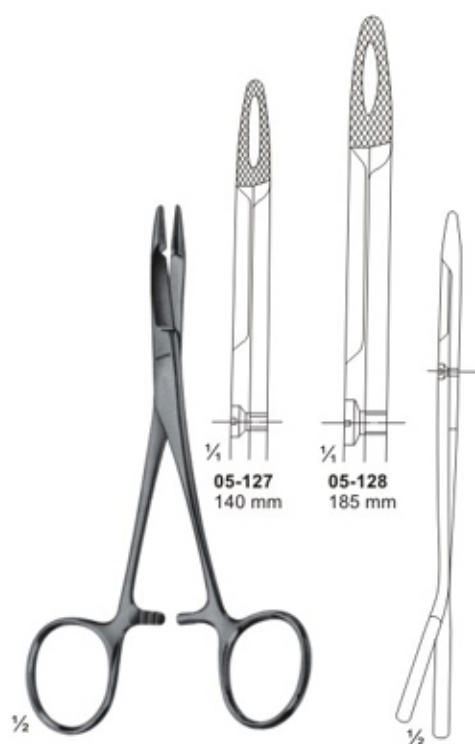

**05-127 - 128**  
**HEGAR-OLSEN**  
255 mm

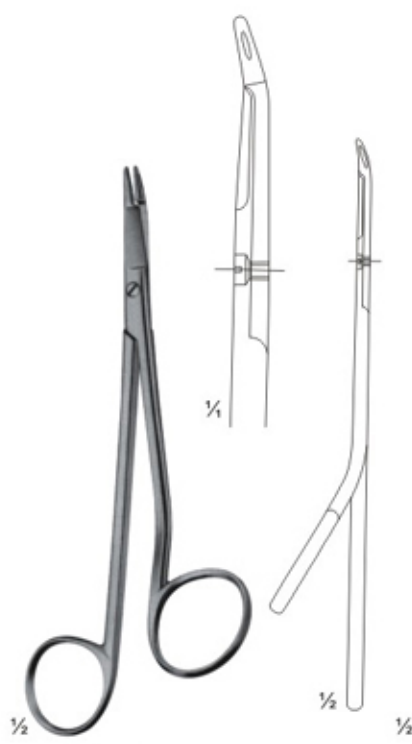

**05-129**  
**GILLIES**  
150 mm



**05-130**  
**GILLIES**  
160 mm



**05-131**  
**EISELSBERG**  
115 mm

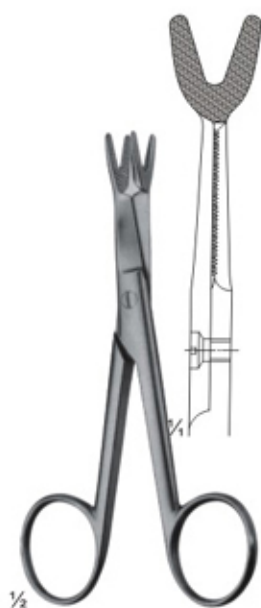

**05-132**  
**SCHOEMAKER-LOTH**  
125 mm



**05-133**  
**CRILE**  
150 mm



**05-134**  
**TOENNIS**  
Elastic pattern for dura-or  
intestinal suture. 180 mm



# Needle Holders

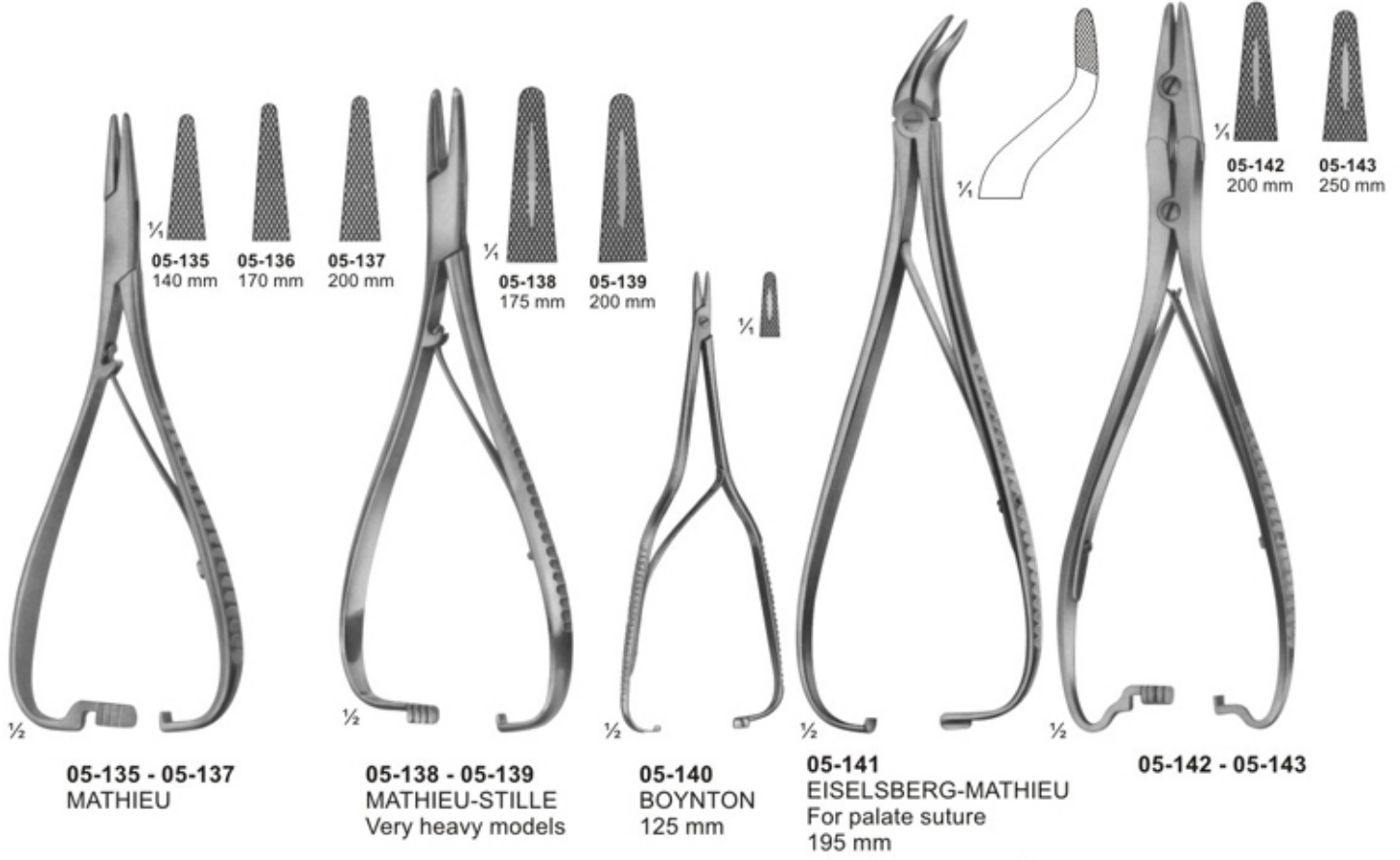

**05-135 - 05-137**  
MATHIEU

**05-138 - 05-139**  
MATHIEU-STILLE  
Very heavy models

**05-140**  
BOYNTON  
125 mm

**05-141**  
EISEISBERG-MATHIEU  
For palate suture  
195 mm

**05-142 - 05-143**

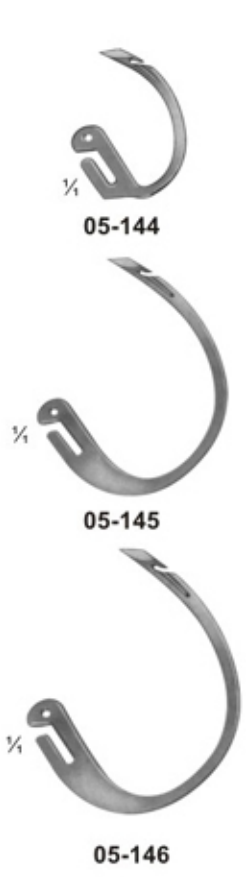

**05-144**

**05-145**

**05-146**



**05-147**  
YOUNG-HRYNTSCHAK  
With 1 needle  
240 mm

**05-148**  
YOUNG-MILLIN  
With 1 needle  
200 mm



**05-149**  
MILLIN  
Ligature holding  
forceps. 245 mm



## Suture Instruments - Reverdin Needles

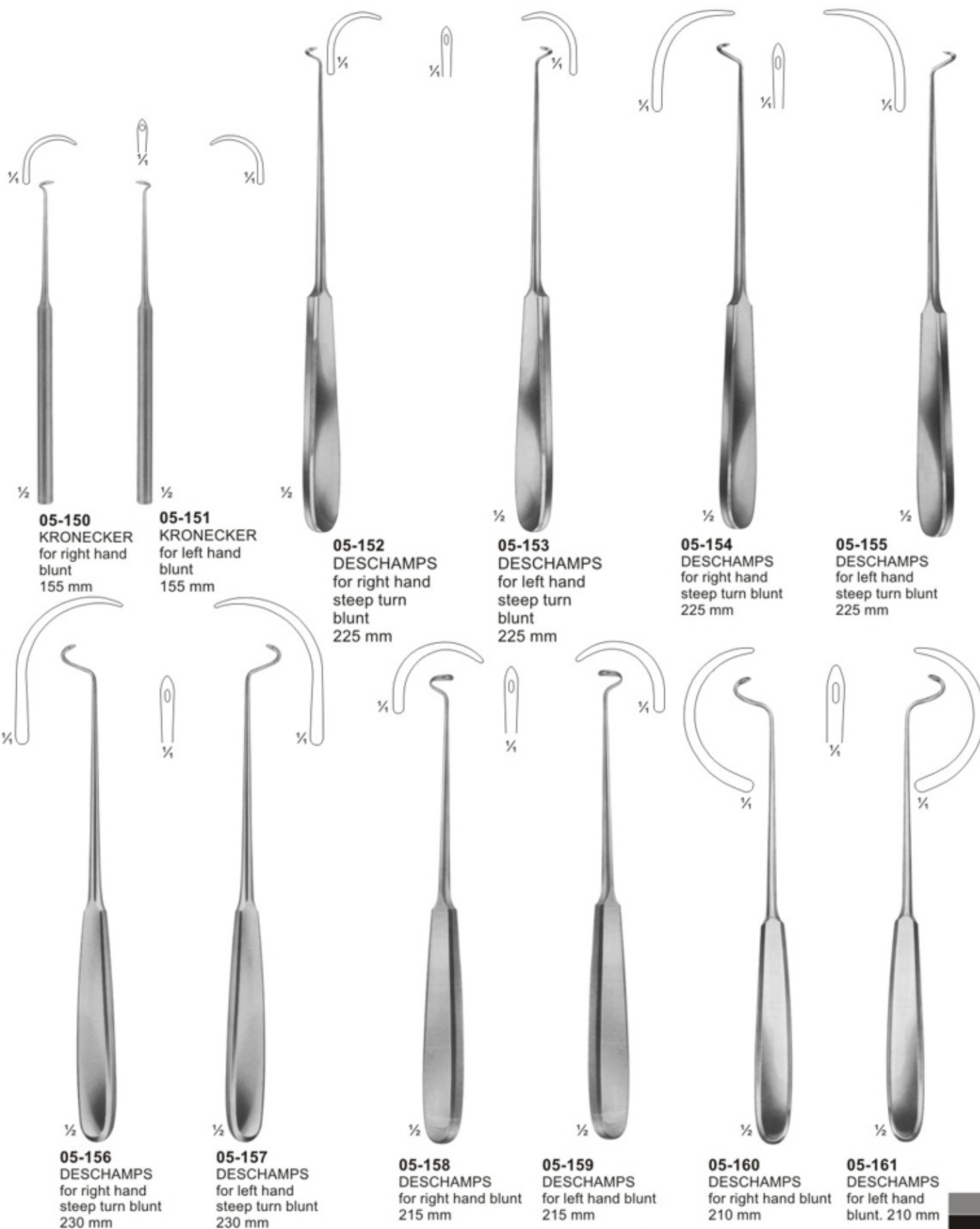





# Probes



**05-162** 130 mm  
**05-163** 145 mm  
**05-164** 160 mm  
Directors



**05-165**  
**DOYEN**  
145 mm  
Directors



**05-166**  
**NELATON**  
160 mm  
Directors



**05-167**  
Director with tip  
Diam. Of tip 3,3 mm  
140 mm

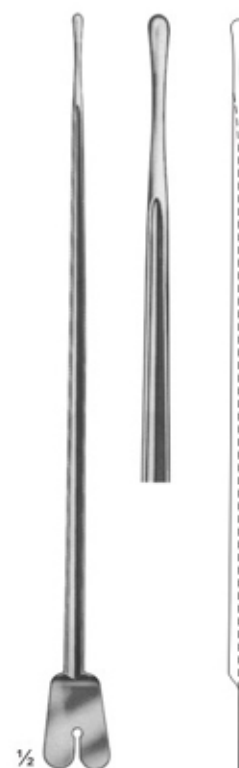

**05-168**  
**BRODIE**  
Director with tip,  
Diam. Of tip 3,5 mm  
200 mm

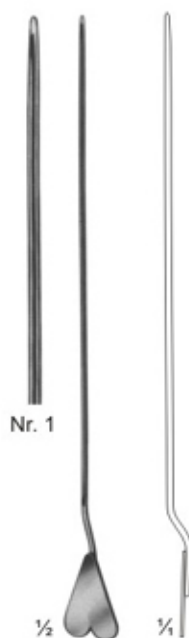

**05-169**  
**LOCKHART-MUMMERY**  
165 mm

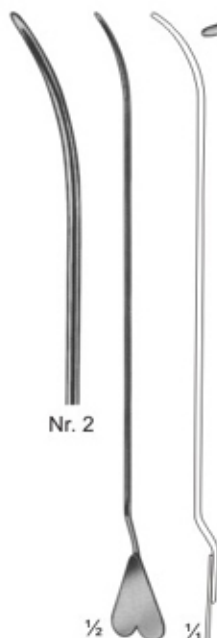

**05-170**  
**LOCKHART-MUMMERY**  
165 mm

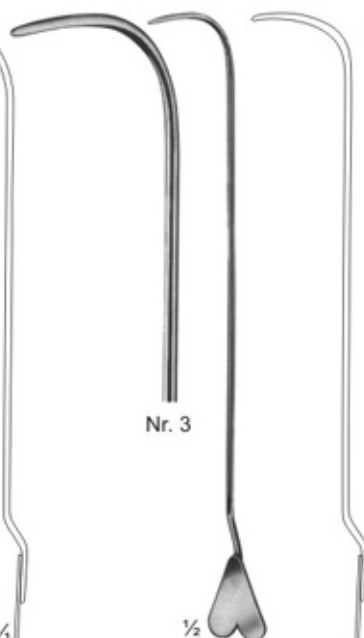

**05-171**  
**LOCKHART-MUMMERY**  
165 mm

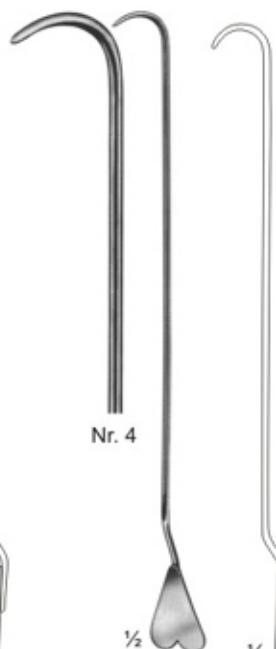

**05-172**  
**LOCKHART-MUMMERY**  
165 mm



**05-173**  
Director with wire  
loop, malleable  
190 mm

# Probes



05-174 145 mm  
05-175 160 mm  
05-176 200 mm  
Probes with eye



05-177  
Myrtle leaf probe  
145 mm



05-178 130 mm  
05-179 145 mm  
05-180 160 mm  
05-181 180 mm  
05-182 200 mm



05-183  
Probes



05-184  $\frac{1}{2}$   
Double ended probe,  
malleable, diam. of tips  
3 mm with hole  
190 mm



05-185  
Double ended probes,  
tin, malleable,  
diam. of tips  
3,5 mm with hole  
250 mm, 300 mm



05-186  $\frac{1}{4}$   
Double ended probes,  
tin, malleable,  
diam. of tips 4 mm  
400 mm



$\frac{1}{2}$   $\varnothing$  tip  
05-187 1,5 mm  
05-188 2,0 mm  
05-189 2,5 mm  
300 mm



## Suturing Instrument Set, Pocket Instrument Set



### 05-190

Suturing instruments set, in metal case consisting of: Scissors, curved, sharp/sharp, 115mm  
25 MICHEL clip, 16 x 3mm  
1 Delicate tissue forceps, 130mm  
1 Scalpel, bellied  
1 MATHIEU needle holder, 140mm  
1 Perforated metal case, stainless containing:  
1 Suture needle  
1 item 1 item



### 05-191

Pocket instrument set, in metal case consisting of:

#### Bottom tray

1 MATHIEU needle holder, 140mm  
1 MICHEL clip forceps, combined  
1 Myrtle leaf probe, 130mm  
1 Sharp double curette  
1 Skin hook  
1 Detachable scalpel handle, no.4  
1 Perforated metal case, containing  
6 Scalpel blades  
1 Perforated metal case, stainless, containing  
1 Suture needle  
1 item  
1 item



#### Top tray

1 Tissue forceps, 130mm  
1 KOCHER haemostatic forceps, 130mm  
1 Straight surgical scissors, 130mm  
1 Dissecting forceps, 130mm  
1 FEILCHENFELD splinter forceps, 115mm  
25 MICHEL clip, 16 x 3mm  
1 Flacon of suture skin, sterile in alcohol



### 05-192

Pocket instrument set, in metal case consisting of:

#### Bottom tray

1 MAYO-HÉGER needle holder, 150mm  
1 MICHEL clip forceps, combined  
1 Myrtle leaf probe, 130mm  
1 Sharp double curette  
1 Skin hook  
1 Detachable scalpel handle, no. 4  
1 Perforated metal case, consisting  
6 Scalpel blades  
1 Perforated metal case, stainless, consisting:  
1 Suture needle  
1 item, & 1 item



#### Top tray

1 Tissue forceps, 130mm  
1 CRILE haemostatic forceps, 140mm  
1 Straight surgical scissors, 130mm  
1 Dissecting forceps, 130mm  
1 FEILCHENFELD splinter forceps, 115mm  
25 MICHEL clip, 16 x 3mm  
1 Flacon of suture silk, sterile in alcohol



## Fine Wound Retractors (Dura- and Skin Retractors)

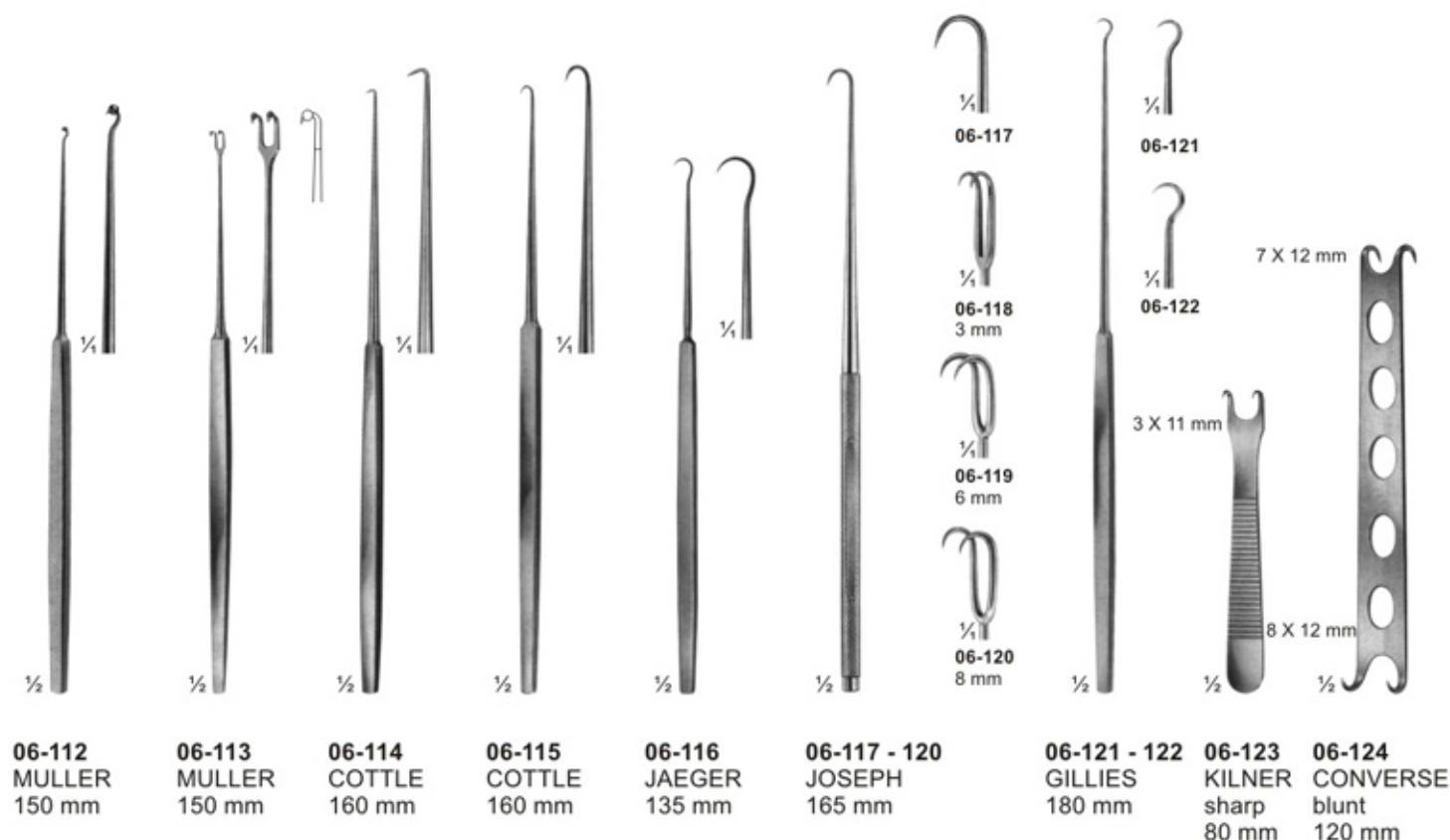
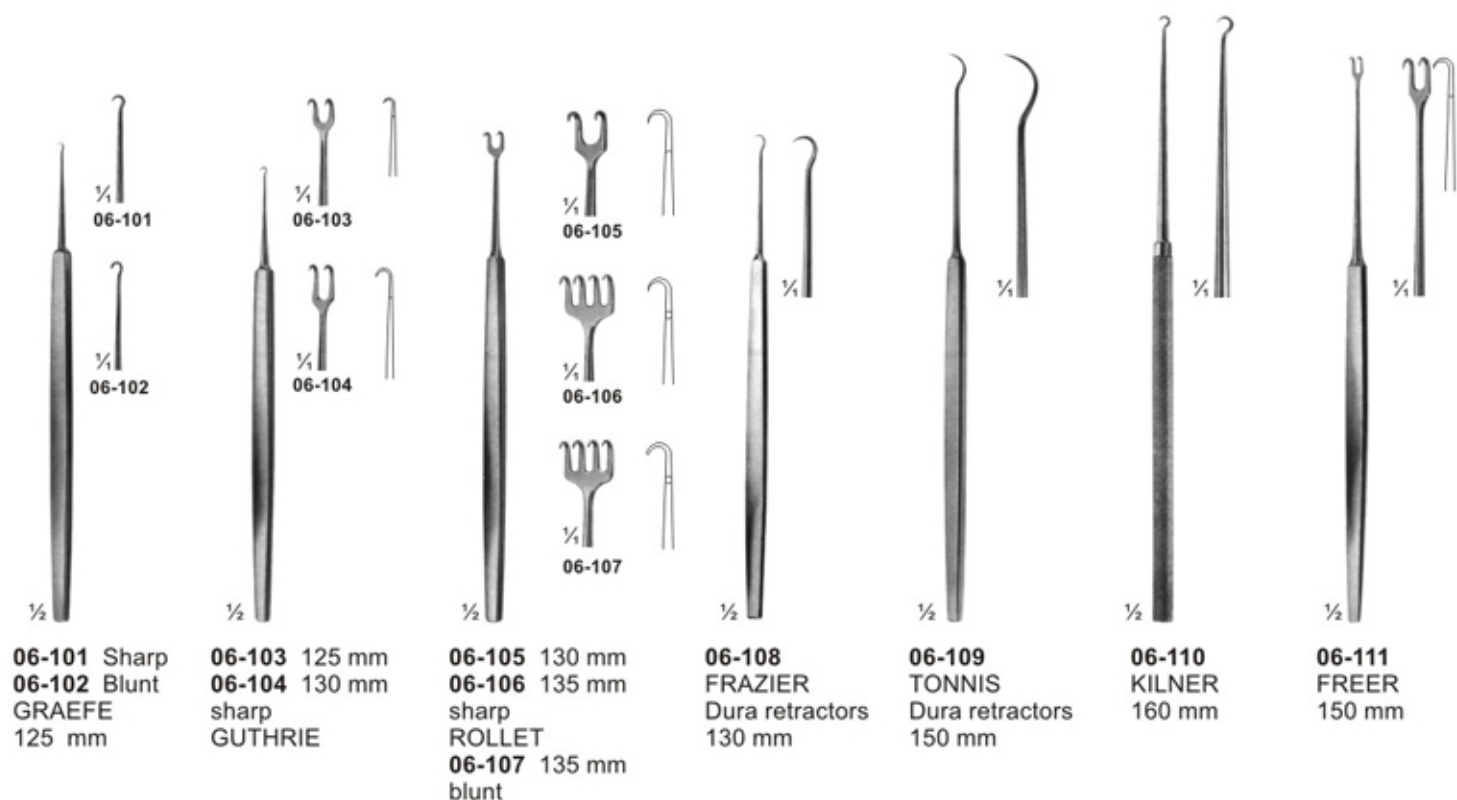





## Retractors With treangle handle

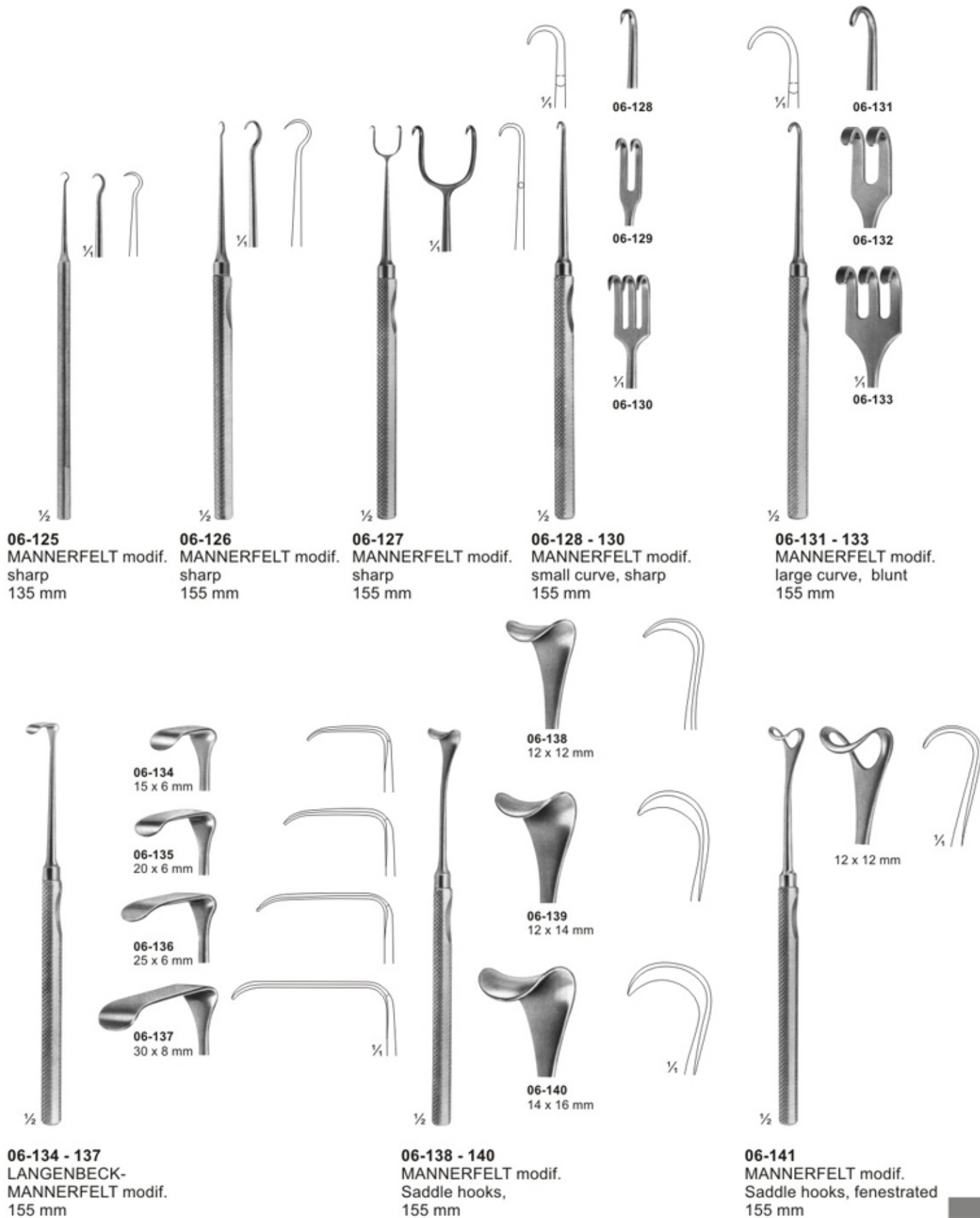



# Retractors



1/4  
6 x 12 mm

1/2  
**06-142**  
MASING  
140 mm

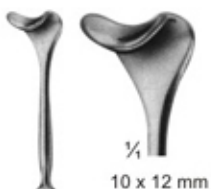

1/4  
10 x 12 mm

1/2  
**06-143**  
COTTLE  
140 mm



1/4  
**06-144**  
9 x 9 mm

1/2  
**06-144 - 148**  
DESMARRES  
140 mm



1/4  
**06-145**  
9 x 12 mm



1/4  
**06-147**  
12 x 16 mm



1/4  
**06-146**  
11 x 14 mm



1/4  
**06-148**  
13 x 18 mm



1/4  
**06-149**  
13 x 13 mm



1/4  
**06-150**  
12 x 16 mm

1/2  
**06-149 - 150**  
KONIG  
180 mm



1/4  
10 x 10 mm

1/2  
**06-151**  
CUSHING-KOCHER  
175 mm



1/4  
**06-152**  
20 x 12 mm

1/2  
**06-152 - 153**  
KOCHER  
205 mm



1/4  
**06-153**  
20 x 15 mm



1/4  
13 x 6 mm

1/2  
**06-154**  
SCHOENBORN  
200 mm



1/4  
**06-155**  
10 x 13 mm

1/2  
**06-155 - 156**  
CUSHING  
205 mm



1/4  
**06-156**  
14 x 18 mm



20 x 15 mm

20 x 19 mm

1/2  
**06-157**  
205 mm

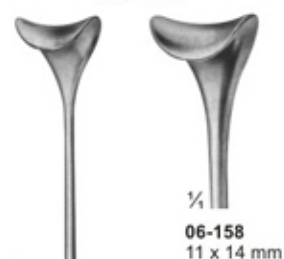

1/4  
**06-158**  
11 x 14 mm

1/2  
**06-158 - 160**  
CUSHING  
250 mm



1/4  
**06-159**  
13 x 18 mm



1/4  
**06-160**  
15 x 22 mm

# Retractors



# Retractors

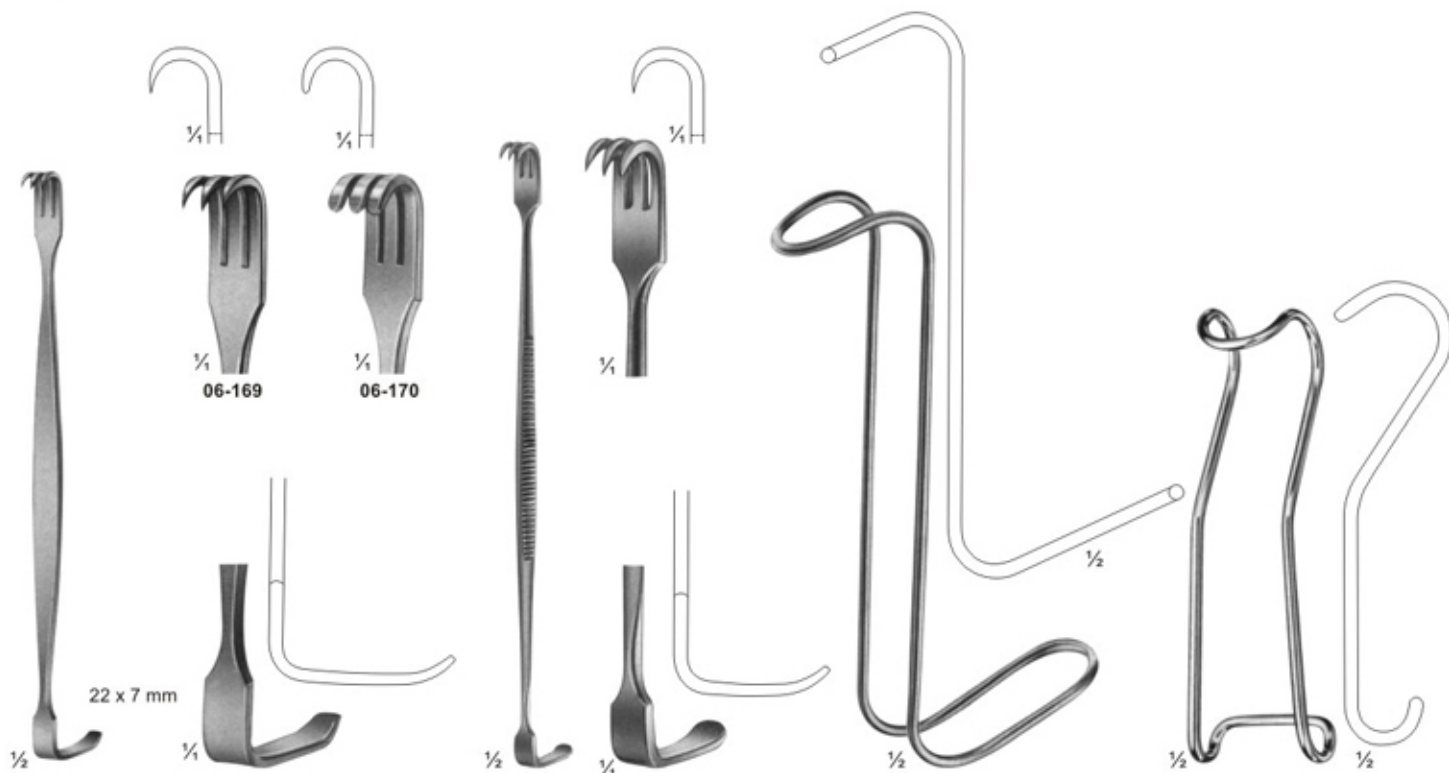

**06-169 - 06-170**  
**BABY-SENN-MILLER**  
 155 mm

**06-171**  
**SENN-MILLER**  
 165 mm

**06-172**  
**COLLIN-HARTMANN**  
 150 mm

**STERBERG**  
**06-173** 120 mm  
**06-174** 130 mm  
**06-175** 135 mm  
**06-176** 140 mm

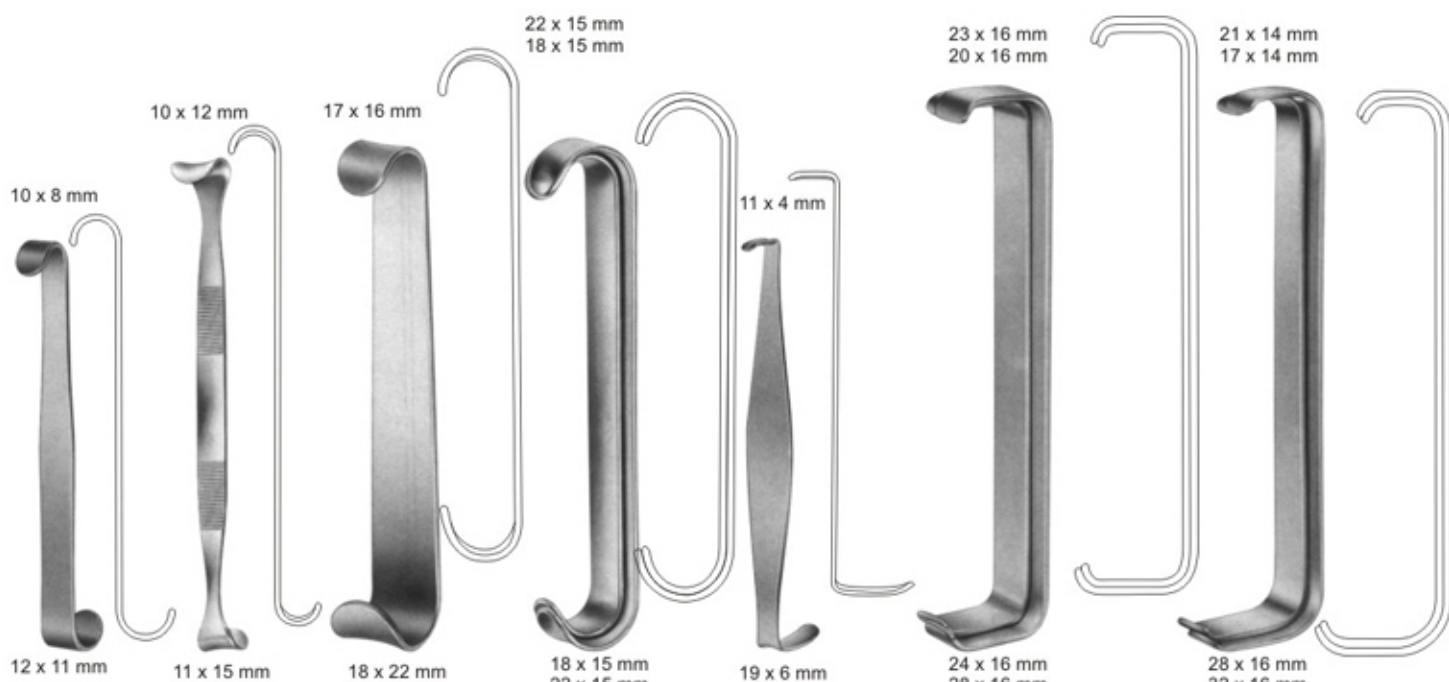

**06-177**  
**LUER**  
 110 mm

**06-178**  
**ROSE**  
 130 mm

**06-179**  
**BABY-ROUX**  
 135 mm

**06-180**  
**PARKER**  
 135 mm

**06-181**  
**CRILE**  
 110 mm

**06-182**  
**FARABEUF**  
 150 mm

**06-183**  
**COLLIN**  
 150 mm





## Bone Retractors and Retractors



**06-184**  
KOCHER  
sharp  
205 mm



**06-185**  
KOCHER  
sharp  
220 mm



**06-186**  
KOCHER  
sharp  
220 mm



**06-187**  
VOLKMANN  
blunt  
220 mm



**06-188**  
VOLKMANN  
sharp  
220 mm



**06-189 - 06-196**  
VOLKMANN  
225 mm



Sharp

1/4



**06-189**  
9 x 8 mm



**06-190**  
9 x 13 mm



**06-191**  
9 x 19 mm



**06-192**  
9 x 29 mm



Blunt

1/4



**06-193**  
8,5 x 8 mm



**06-194**  
8,5 x 13 mm



**06-195**  
8,5 x 19 mm



**06-196**  
8,5 x 29 mm

# Retractors



**06-197 - 06-199**  
MIDDELDORPF



$\frac{1}{2}$   
**06-197**  
15 x 15 mm  
220 mm



$\frac{1}{4}$



$\frac{1}{2}$   
**06-198**  
20 x 22 mm  
215 mm



$\frac{1}{4}$



$\frac{1}{2}$   
**06-199**  
28 x 28 mm  
235 mm



$\frac{1}{4}$



$\frac{1}{2}$   
**06-200**  
BUCHS  
205 mm



38 x 18 mm



67 x 17 mm

$\frac{1}{4}$



$\frac{1}{2}$   
**06-201**  
CASPAR  
210 mm



$\frac{1}{2}$   
**06-202**  
KOCHER  
230 mm

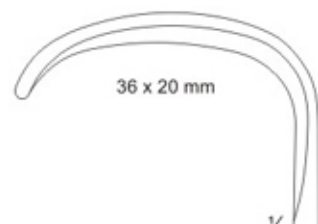

36 x 20 mm

$\frac{1}{4}$

# Retractors, Vario Retractor System



- 06-203-06-209**  
BRUNNER  
275 mm
- 06-203 80 x 20
  - 06-204 100 x 25
  - 06-205 120 x 25
  - 06-206 130 x 30
  - 06-207 140 x 30
  - 06-208 160 x 30
  - 06-209 180 x 30



**06-210**  
Handle with cold  
light carrier for  
retractor blades.  
280 mm



Handle arrange-  
ment verriable

## Retractors, Lung Spatulas







**Benodict**  
SURGICAL INSTRUMENTS

**Retractors for deep surgery  
(Abdominal Retractors)**



91 x 35 mm

1/4

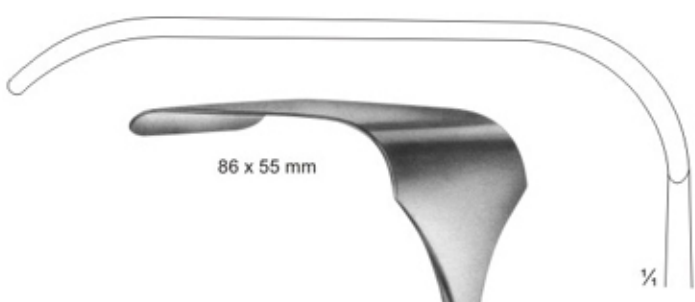

86 x 55 mm

1/4

1/2

**06-217**  
**MIKULICZ**  
250 mm

1/2

**06-216**  
**MIKULICZ**  
255 mm

# Retractors, Abdominal Retractors

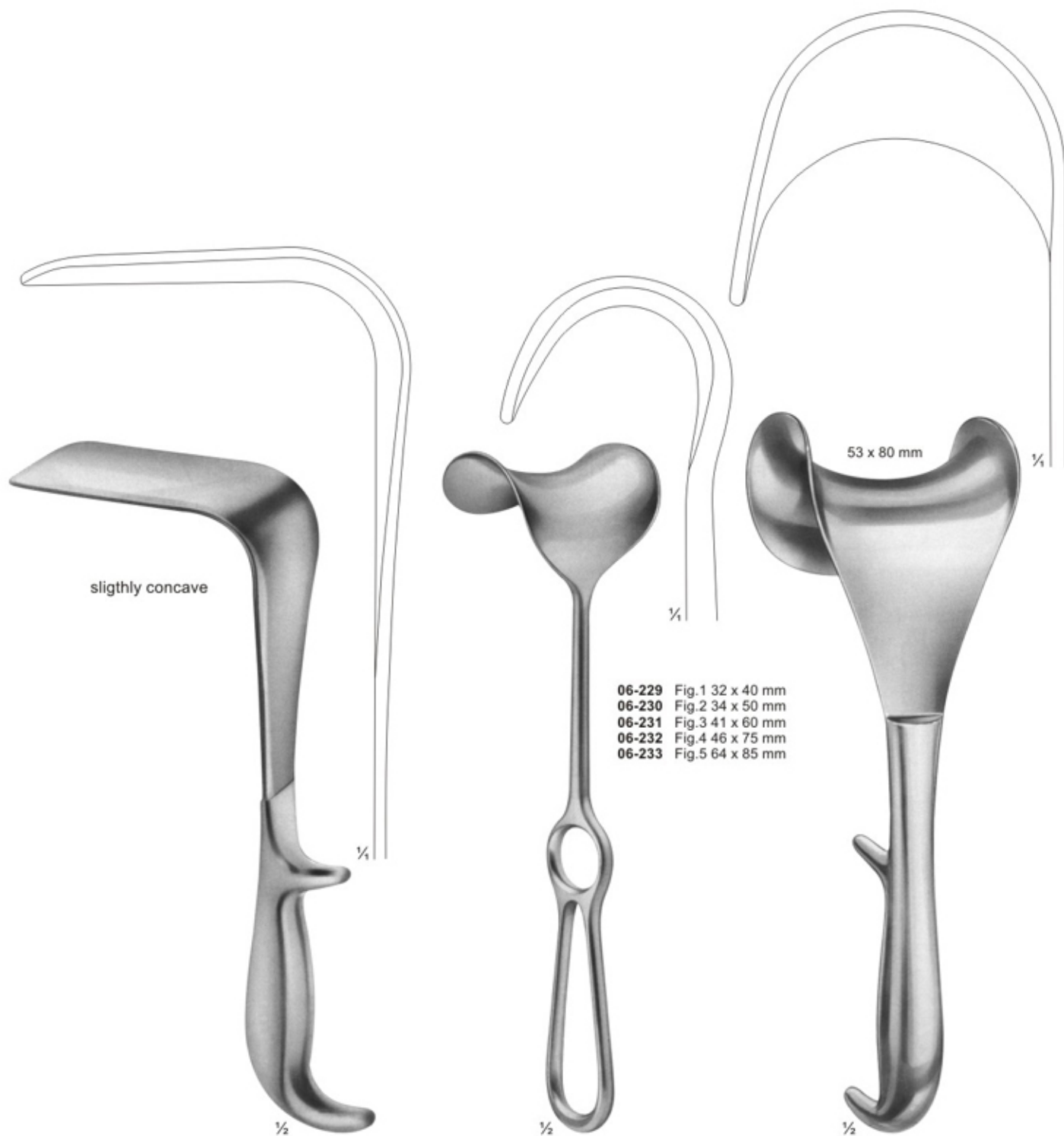

- 06-229 Fig.1 32 x 40 mm
- 06-230 Fig.2 34 x 50 mm
- 06-231 Fig.3 41 x 60 mm
- 06-232 Fig.4 46 x 75 mm
- 06-233 Fig.5 64 x 85 mm

**06-218 - 06-228**  
DOYEN  
240 mm

**06-229 - 06-233**  
FRITSCH  
240 mm

**06-234**  
DOYEN  
250 mm

	width of blades	35 mm, 45 mm, 60 mm
length of blades		
62 mm	06-218, 06-222, 06-226	
92 mm	06-219, 06-223, 06-227	
122 mm	06-220, 06-224, 06-228	
160 mm	06-221, 06-225	



**Benodict**  
SURGICAL INSTRUMENTS

**Abdominal- and Intestinal Spatulas**  
**Bauch- und Darmspatel**



**06-235**  
LERICHE  
255 mm

**06-236**  
KUMMEL  
Mealleable  
285 mm

**06-237**  
MIKULICZ  
29 mm  
250 mm

**06-238 - 06-239**  
KADER  
**06-238** 30 mm  
**06-239** 40 mm  
270 mm

## Self-Retaining Retractors

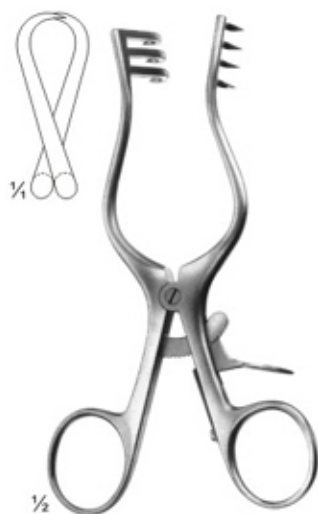

**06-240**  
WEITLANER  
sharp  
130 mm

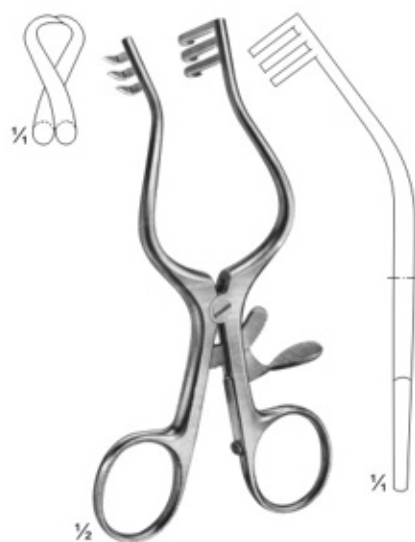

**06-241**  
WULLSTEIN  
sharp  
130 mm

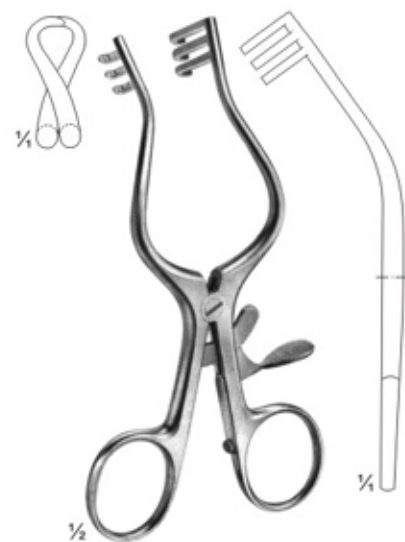

**06-242**  
WULLSTEIN  
blunt  
130 mm



**06-243**  
WEITLANER  
sharp  
165 mm



**06-244**  
PLESTER  
blunt  
110 mm



**06-245**  
PERKINS  
130 mm



**Special Retractors**



**06-246**  
JOLL ( FRIEDMAN )  
Thyroid- and vaginal retractor  
155 mm

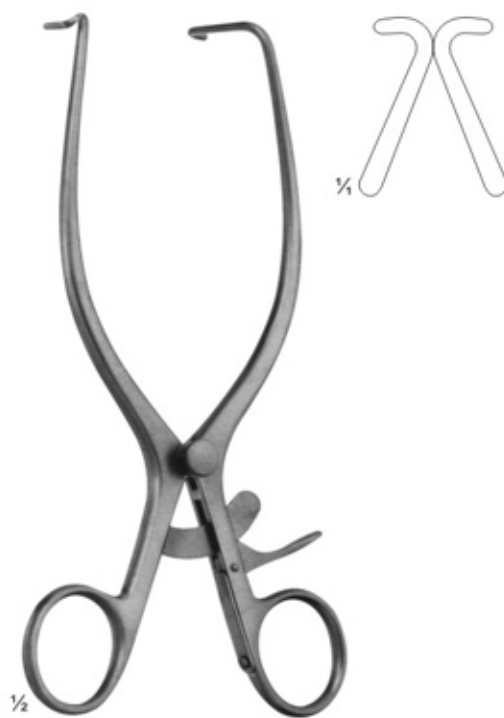

**06-247**  
JACKSON BURROWS  
Retractor, blunt  
185 mm



**06-248**  
GELPI  
Vaginal retractor  
135 mm

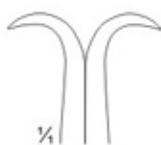

**06-249**  
GELPI  
Skin- and vaginal retractor  
175 mm



**06-250**  
DE BAKKEY  
Femur retractor  
145 mm

## Lamina Spreaders



**06-251**  
CLOWARD  
155 mm



**06-252**  
CLOWARD  
135 mm



**06-253**  
INGE  
170 mm

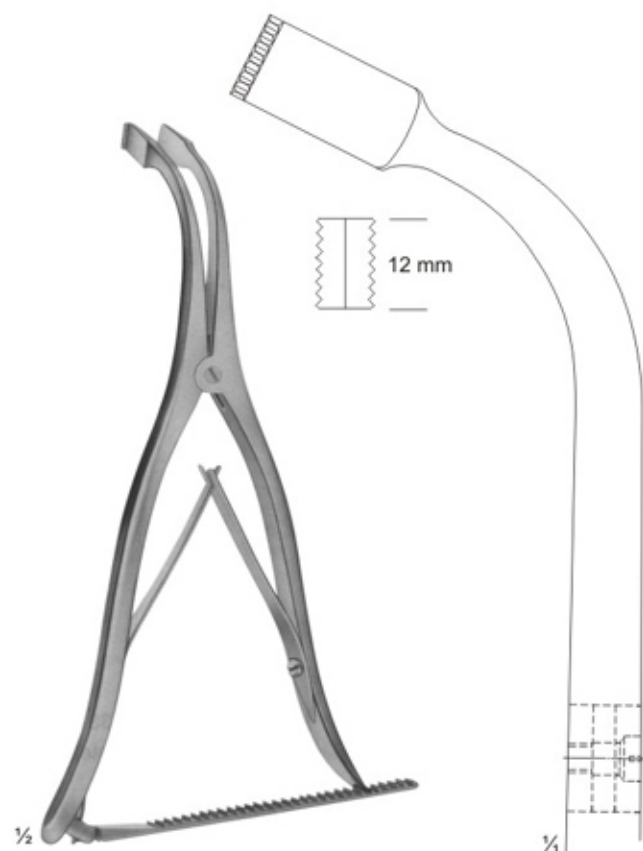

**06-254**  
INGE  
275 mm

## Abdominal Retractors

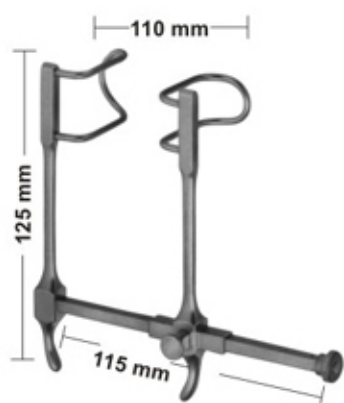

**06-255**  
GOSSET  
Blades: 38 mm deep

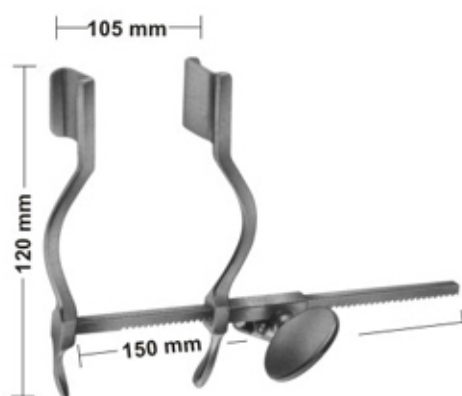

**06-256**  
HERTZLER  
Blades 20 X 25 mm

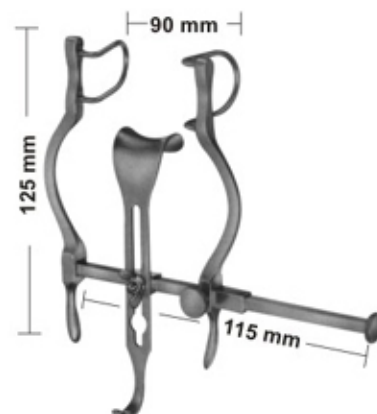

**06-257**  
BALFOUR-BABY  
Lateral blades 27 mm deep  
Center blade 21x24 mm

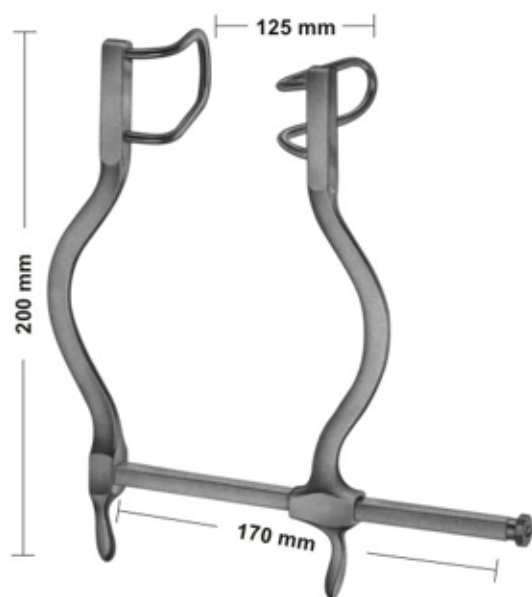

**06-258**  
GOSSET  
Blades: 55 mm deep

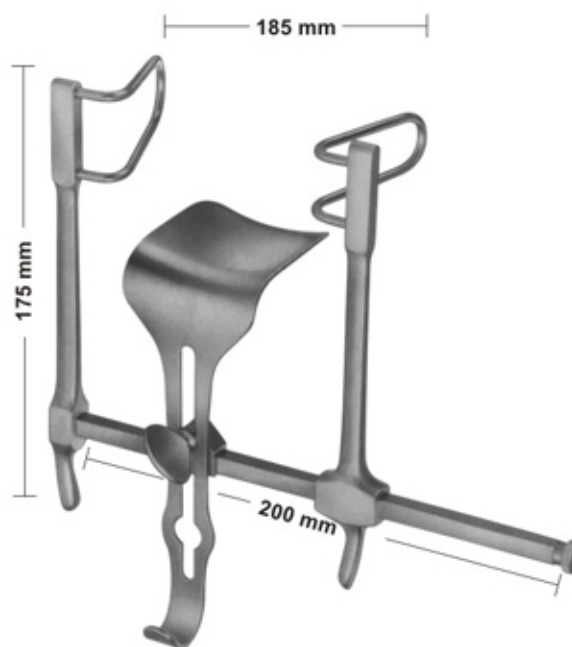

**06-259**  
GOSSET  
Lateral blades 58 mm deep  
Center blade 59 x 57 mm

# Organ-, Tissue and Intestinal Grasping Forceps

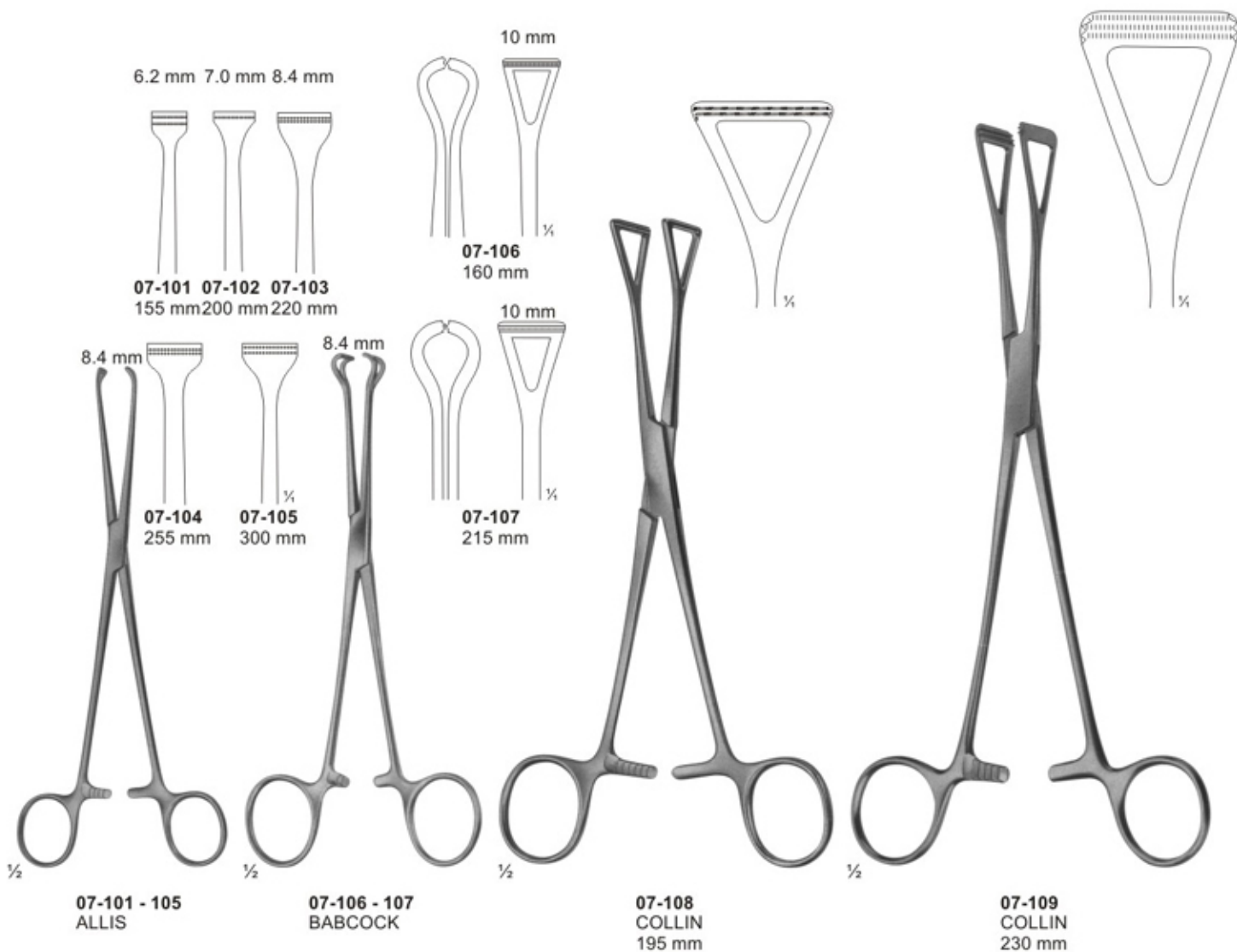



**Intestinal Clamps, soft elastic**

**ATRAUMATA**

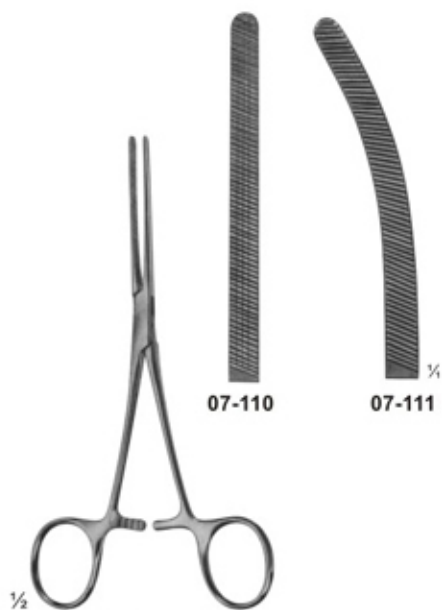

**07-110 - 111**  
DOYEN  
elastic  
165 mm

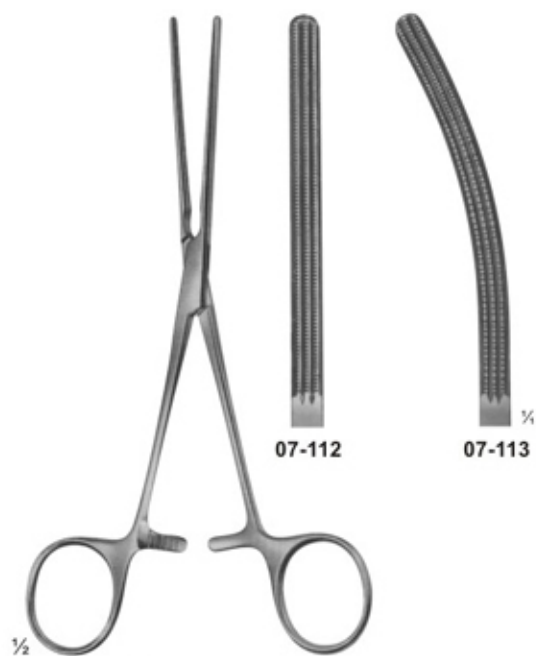

**07-112 - 113**  
DOYEN  
with elastic blades  
170 mm

**ATRAUMATA**

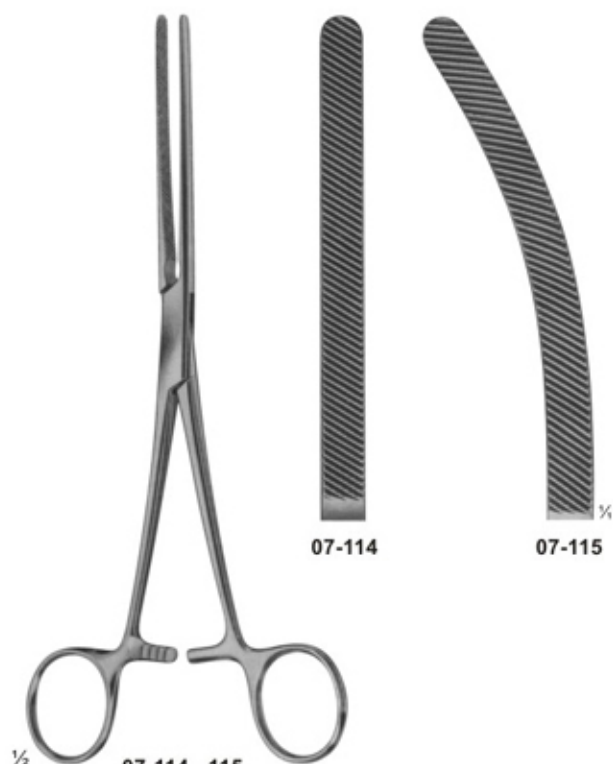

**07-114 - 115**  
HARTMANN  
with elastic blades  
200 mm

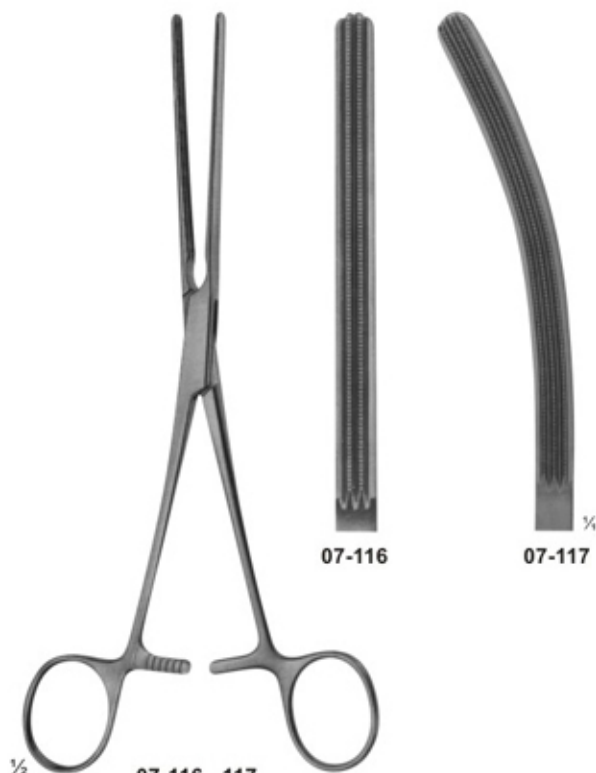

**07-116 - 117**  
HARTMANN  
with elastic blades  
200 mm

## Intestinal and Pylorus Clamps



**07-118**  
PAYR  
Intestinal clamp  
light pattern,  
for children  
180 mm

**07-119**  
PAYR  
200 mm

**07-120**  
PAYR  
275 mm

**07-121**  
PAYR  
Pylorus clamp  
315 mm

**ATRAUMATA**  
**Sigmoid Anastomosis Forceps**

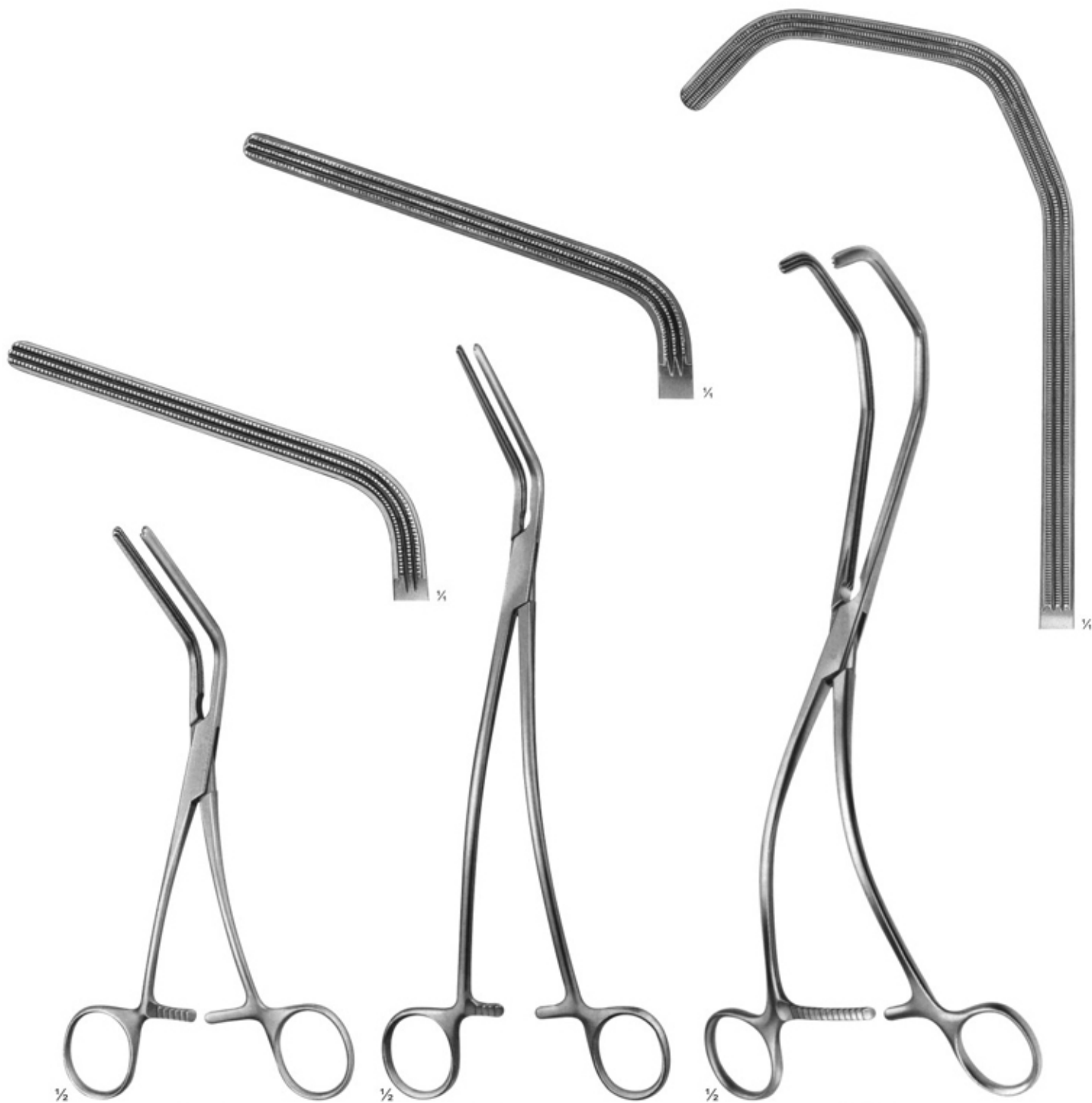

1/2  
**07-122**  
**MORRIS**  
175 mm

1/2  
**07-123**  
**DE BAKEY**  
(MORRIS modif.)  
240 mm

1/2  
**07-124**  
**KERSTING**  
270 mm

# Nasal Specula



**08-101**  
Martin  
13 cm / 5 1/8"



**08-102**  
SIMS  
160 mm



**08-103**  
Tieck-Halle  
13 cm / 5 1/8"



**08-104**  
Killian

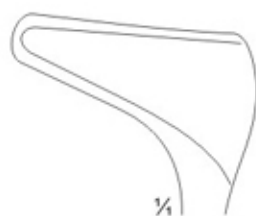

**Fig. 1**  
14 cm 5 4/8"  
35 mm

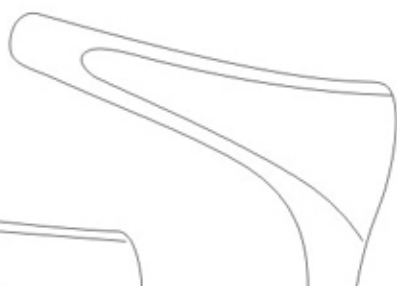

**Fig. 2**  
14,5 cm / 5 4/8"  
50 mm

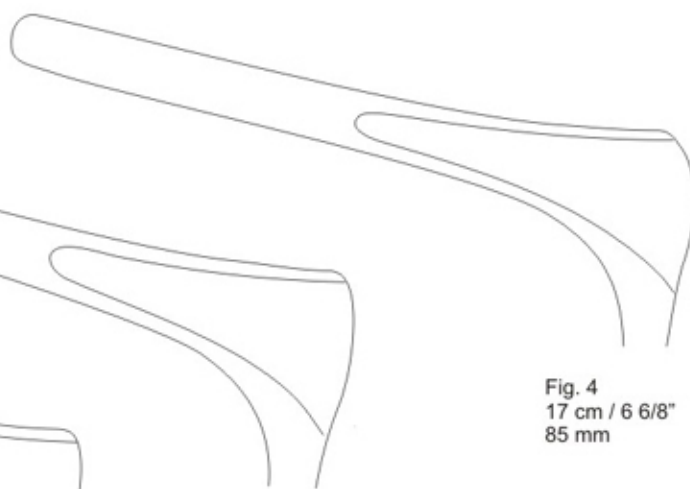

**Fig. 3**  
16 cm / 6 2/8"  
75 mm

**Fig. 4**  
17 cm / 6 6/8"  
85 mm



# Nasal Specula



**08-105**  
Cottle

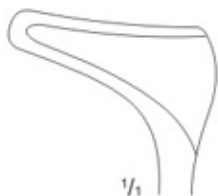

Fig. 1  
13,5 cm / 5 3/8"  
35 mm

1/1

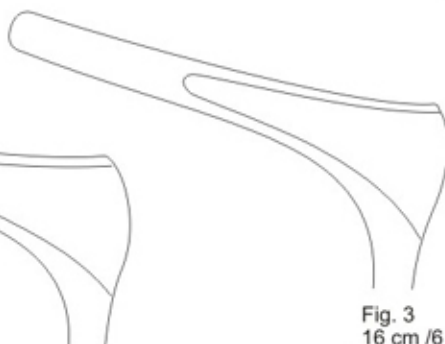

Fig. 2  
14 cm / 5 4/8"  
50 mm



Fig. 3  
16 cm / 6 2/8"  
75 mm

Fig. 4  
16 cm / 6 2/8"  
85 mm



1/2

**08-106**  
Goldsmith (Thudichum)  
6,5 cm / 2 4/8"



Fig. 1  
21,0 x 9,5 mm



Fig. 2  
21,0 x 10,5 mm



Fig. 3  
21,0 x 11,5 mm



1/2

**08-107**  
Mod. Wien 2  
13,5 cm / 5 7/8"



1/1

30 mm



**08-108**  
Hartmann-Halle  
16 cm / 6 7/8"



Fig. 1  
27 mm



Fig. 2  
31 mm



Fig. 3  
35 mm

**Anuscopies-Sphincteroscopes**



**08-109**  
IVES-FANSLER  
Anuscopy  
145 mm  
Ø24mm



**08-110**  
KELLY  
Sphincteroscope  
160 mm  
Ø21mm



**08-111**  
KELLY  
Sphincteroscope  
160 mm  
Ø27mm

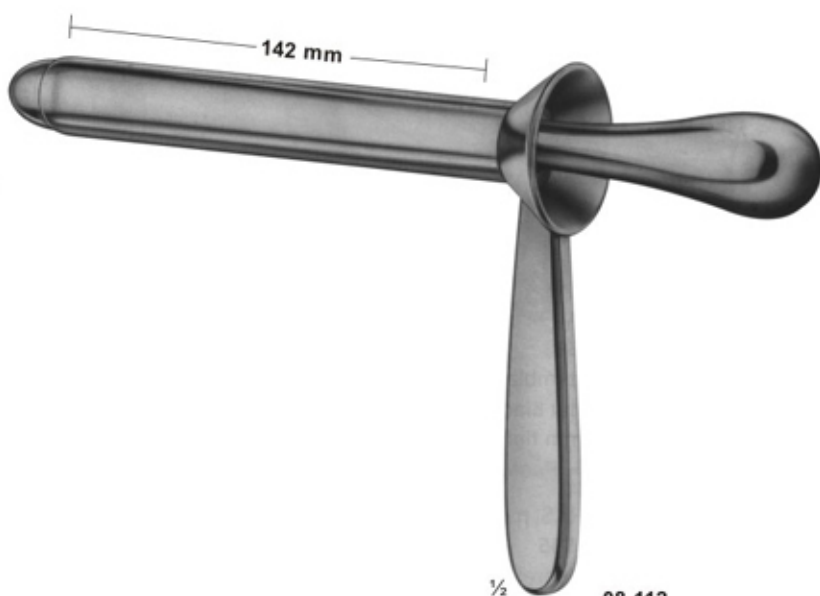

**08-112**  
KELLY  
Proctoscope  
140 mm  
Ø22mm

# Haemorrhoidal Forceps

## ATRAUMATA

### Pressure Clamp

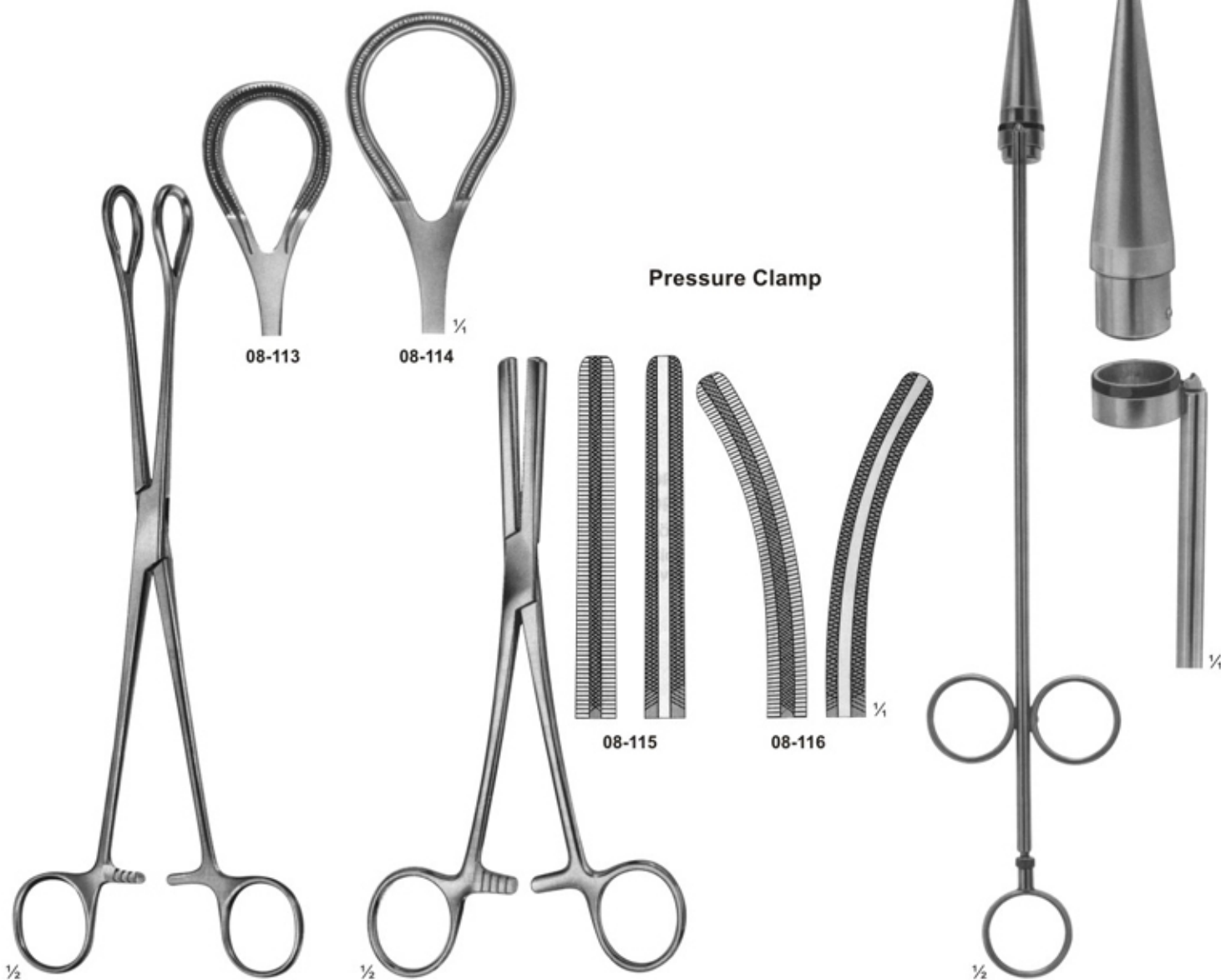

**08-113 - 08-114**  
250 mm  
08-114  
270 mm

**08-115 - 08-116**  
FERGUSSON  
200 mm

**08-117**  
RUDD  
Haemorrhoidal ligator  
with loading  
attachment and 100  
ligature rubber rings  
315 mm



## Gall Duct Forceps



**08-118**  
LOWER  
180 mm



**08-119**  
LAHEY ( SWEET )  
190 mm

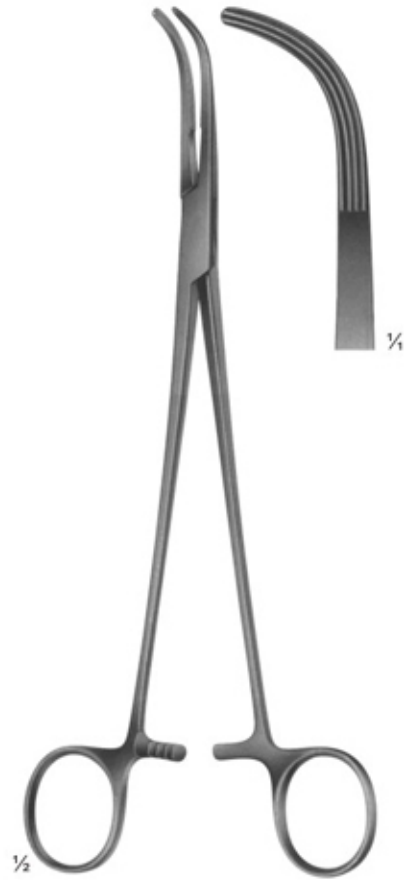

**08-120**  
LAHEY  
220 mm



**08-121**  
DESJARDINS  
Gall duct-and cystic forceps  
210 mm



**08-122**  
NISSEN  
Gall duct-and cystic forceps  
215 mm





# Gall Duct Dilators and Gall Stone Scoops

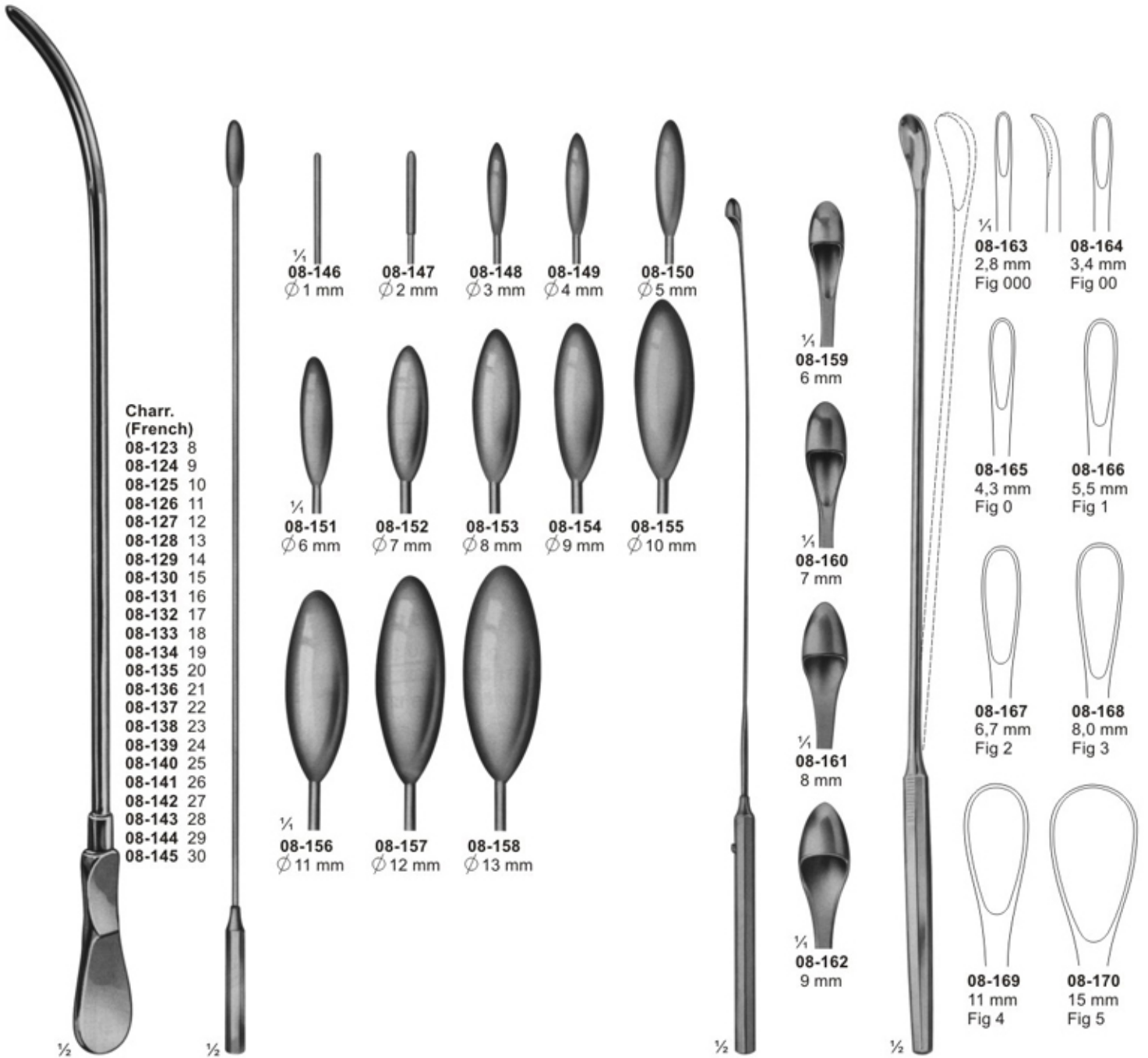

- Charr.  
(French)**
- 08-123 8
  - 08-124 9
  - 08-125 10
  - 08-126 11
  - 08-127 12
  - 08-128 13
  - 08-129 14
  - 08-130 15
  - 08-131 16
  - 08-132 17
  - 08-133 18
  - 08-134 19
  - 08-135 20
  - 08-136 21
  - 08-137 22
  - 08-138 23
  - 08-139 24
  - 08-140 25
  - 08-141 26
  - 08-142 27
  - 08-143 28
  - 08-144 29
  - 08-145 30

1/4  
08-146  
Ø 1 mm

08-147  
Ø 2 mm

08-148  
Ø 3 mm

08-149  
Ø 4 mm

08-150  
Ø 5 mm

1/4  
08-151  
Ø 6 mm

08-152  
Ø 7 mm

08-153  
Ø 8 mm

08-154  
Ø 9 mm

08-155  
Ø 10 mm

1/4  
08-156  
Ø 11 mm

08-157  
Ø 12 mm

08-158  
Ø 13 mm

1/4  
08-159  
6 mm

08-160  
7 mm

1/4  
08-161  
8 mm

08-162  
9 mm

1/4  
08-163  
2,8 mm  
Fig 000

08-164  
3,4 mm  
Fig 00

08-165  
4,3 mm  
Fig 0

08-166  
5,5 mm  
Fig 1

08-167  
6,7 mm  
Fig 2

08-168  
8,0 mm  
Fig 3

08-169  
11 mm  
Fig 4

08-170  
15 mm  
Fig 5

**08-123 - 08-145**  
**DITTEL**  
Metall bougies and  
dilating sounds, stiff  
345 mm

**08-146 - 08-158**  
**BAKES**  
Common bile duct  
dilators, malleable  
**08-146 - 08-150** 315 mm  
**08-151 - 08-158** 320 mm

**08-159 - 08-162**  
**DESJARDINS**  
Probe and catch  
with flexible schaft  
300 mm

**08-163 - 08-170**  
**LUER-KOERTE modif**  
with malleable shaft  
310 mm



# Gall Stone Forceps

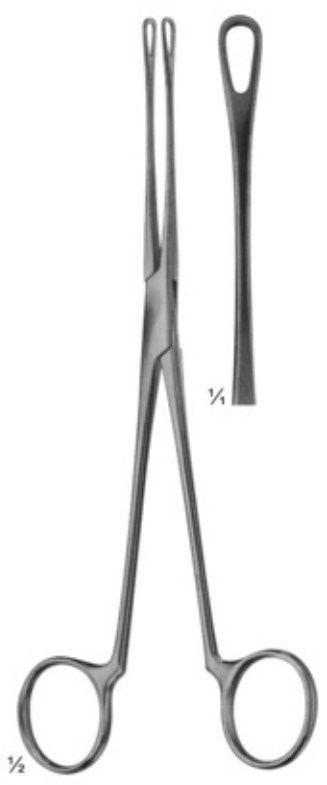

**08-171**  
BLAKE  
205 mm

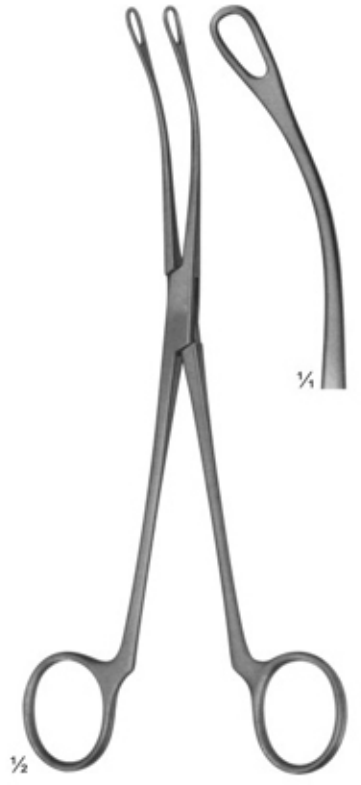

**08-172**  
BLAKE  
205 mm

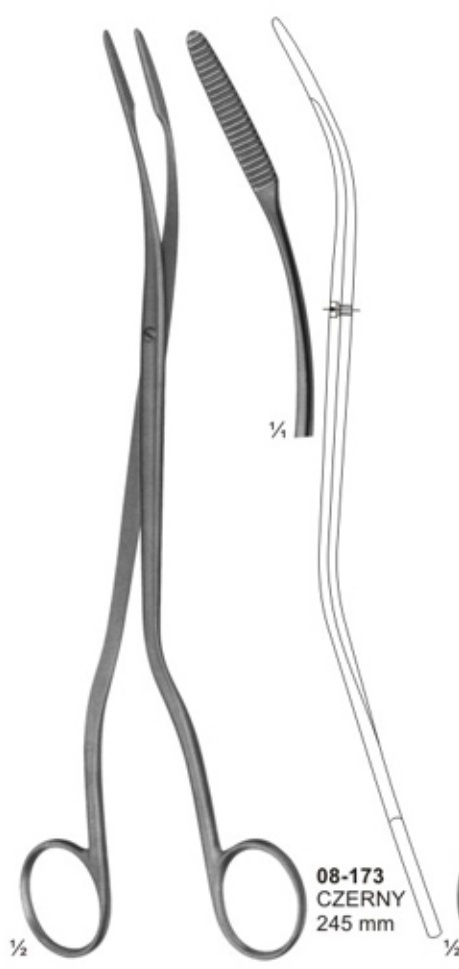

**08-173**  
CZERNY  
245 mm

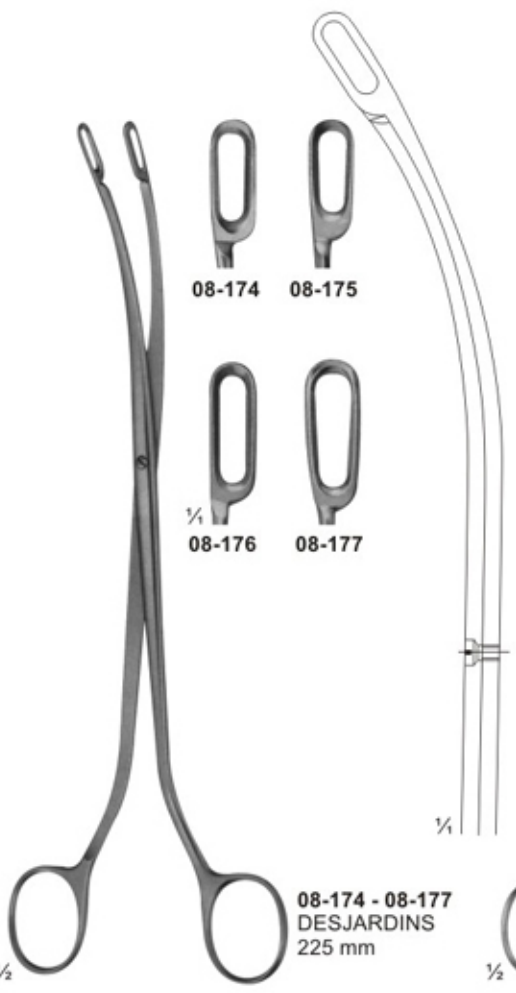

**08-174** **08-175**  
**08-176** **08-177**

**08-174 - 08-177**  
DESJARDINS  
225 mm

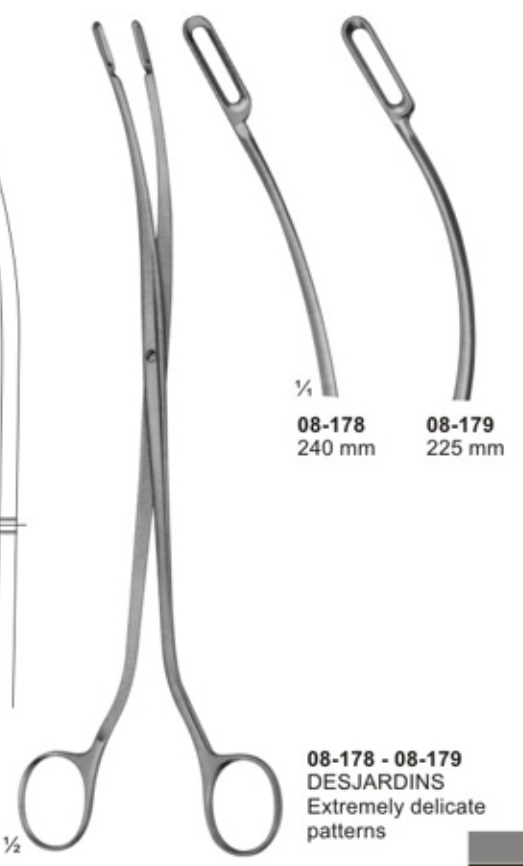

**08-178** **08-179**  
240 mm 225 mm

**08-178 - 08-179**  
DESJARDINS  
Extremely delicate  
patterns

# Kidney Clamps

## ATRAUMATA

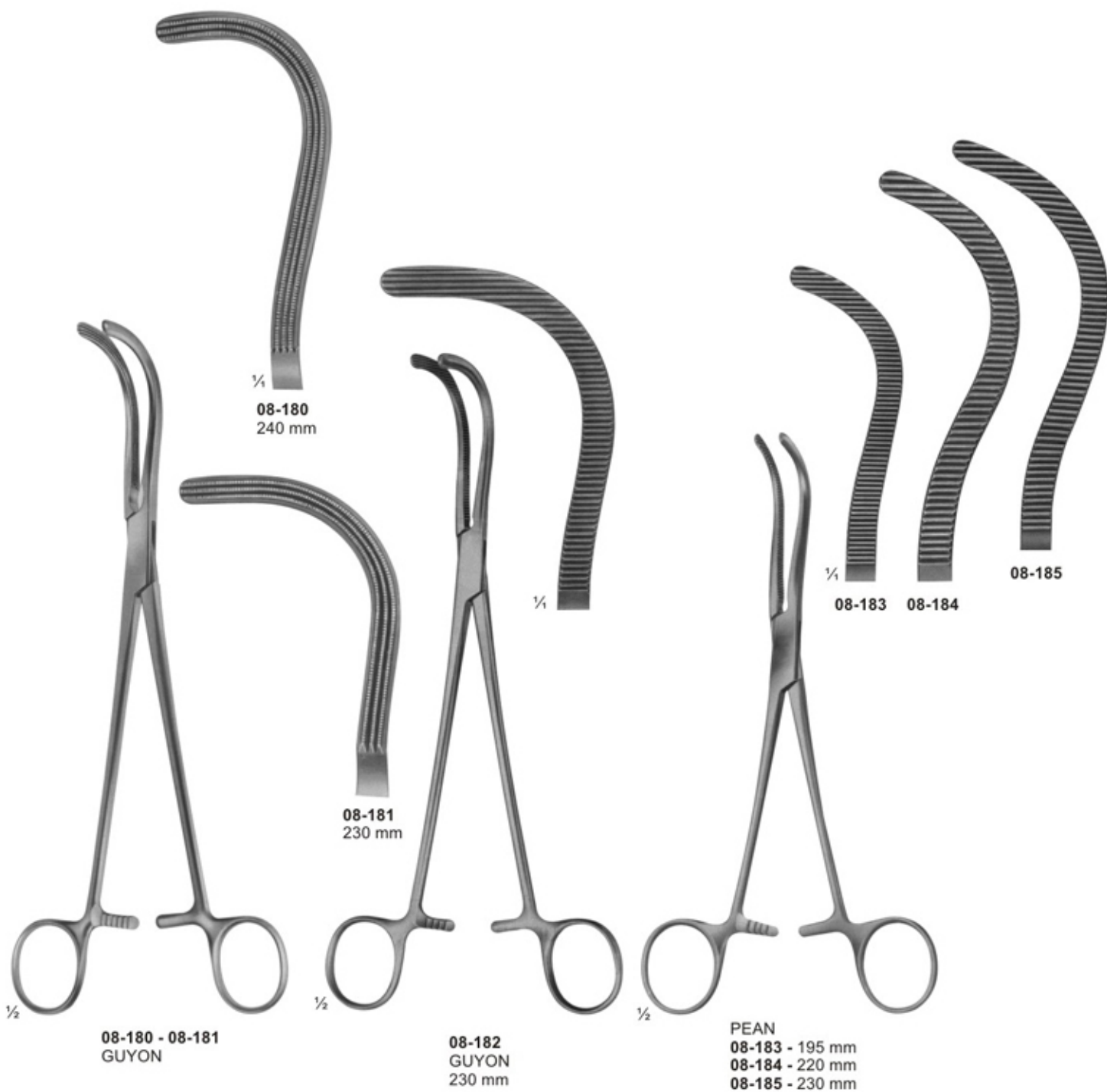

# Kidney Stone Forceps



08-186



08-187



08-188



1/4  
08-189



08-190



08-191



1/4  
08-192



1/2

08-186 - 08-189  
RANDALL  
225 mm



1/2

08-190 - 08-192  
RANDALL  
190 mm





# Bladder Retractors



**09-101**  
JUDD-MASSON  
Bladder-and suprapubic  
retractor

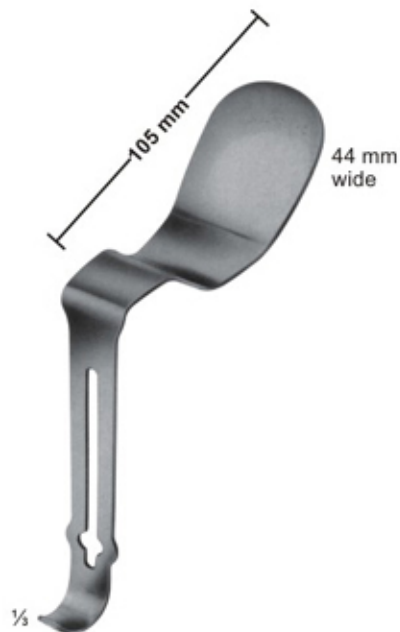

**09-102**  
MILLIN  
Center bladder for  
retro pubic prostatectomy



**09-103**  
MILLIN  
Bladder retractor, complete  
105X45 mm



**09-104**  
LEGUEU  
Bladder retractor  
Center blade  
80 x 31 mm



**09-105**  
KOCHER  
Bladder spatula  
235 mm



# Trocars



**09-106**  
KLIMA ROSEGGER  
35 X 1,8 mm  
Sternal puncture needle



**09-107**  
Universal trocar  
with 4 tips



NELSON



**09-108 - 112**  
Inside diam. Outside diam  
**09-108** 2,2 mm 3,0 mm  
**09-109** 3,0 mm 4,0 mm  
**09-110** 4,0 mm 5,0 mm  
**09-111** 5,0 mm 6,0 mm  
**09-112** 5,5 mm 6,5 mm  
for hydrocele and abdominal  
puncture

**09-113 - 116**  
Inside dime. Outside dime  
**09-113** 2,2 mm 3,0 mm  
**09-114** 3,0 mm 4,0 mm  
**09-115** 4,0 mm 5,0 mm  
**09-116** 5,0 mm 6,0 mm  
for abdominal puncture,  
with stop-cock and lateral  
drain



**09-117 - 118**  
Inside diam. Outside diam  
**09-117** 6,5 mm 8,0 mm  
**09-118** 9,0 mm 10,0 mm  
Empyema trocar  
BUELEU



**09-119 - 122**  
Inside diam. Outside diam  
**09-119** 3,0 mm 4,0 mm  
**09-120** 3,6 mm 4,6 mm  
**09-121** 4,3 mm 5,3 mm  
**09-122** 5,0 mm 6,0 mm  
Gall bladder trocars. OCHSNER



**09-123**  
PIERCE  
Antrum trocar  
Ø 4,0 mm



**09-124**  
COAKLEY  
Antrum trocar  
3,0 mm



# Vaginal Specula

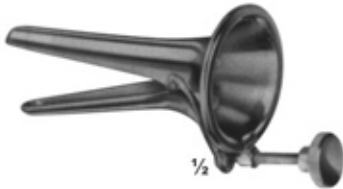

**10-101**  
COLLIN  
for children  
53 x 10 mm

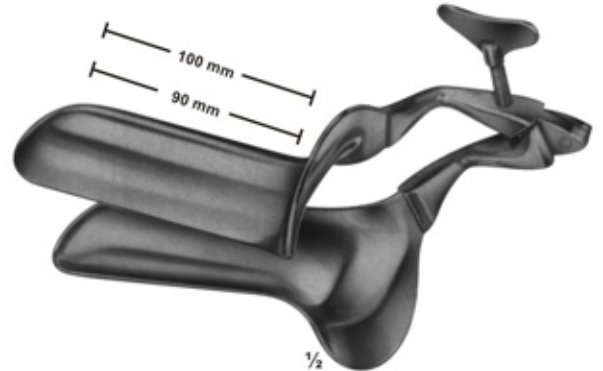

**10-102 - 105**  
COLLIN  

<b>10-102</b>	100/90mm	28 mm
<b>10-103</b>	100/90mm	32 mm
<b>10-104</b>	105/95mm	35 mm
<b>10-105</b>	115/105mm	40 mm

Total length/working length      width



**10-106**  
COLLIN  
for virgins  
95/85 x 18 mm



**10-107**  
CUSCO  
for virgins  
75 x 17 mm



**10-108**  
CUSCO  
for virgins  
75 x 17 mm

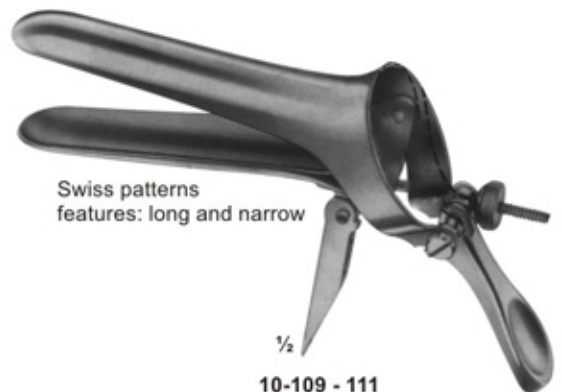

Swiss patterns  
features: long and narrow

**10-109 - 111**  
CUSCO  

<b>10-109</b>	92X23-25 mm
<b>10-110</b>	100x25-27 mm
<b>10-111</b>	110x27-30 mm



## Vaginal Specula- Sets, upper and lower blades



**10-112 - 114**  
GRAVE  
10-112 75X20 mm  
10-113 95X30 mm  
10-114 105X33 mm

1/2



**10-115 - 116**  
PEDERSON  
10-115 100X22 mm  
10-116 120X25 mm

1/2



**10-117 - 118**  
BRIESKY  
10-117 72X25 mm / 77X30 mm 140 mm  
10-118 75X30 mm / 92X38 mm 170 mm

1/2



**10-119**  
SIMS  
70 X 26 mm / 75 X 30 mm  
75 X 30 mm / 80 X 35 mm  
80 X 36 mm / 90 X 40 mm  
175 mm

1/2



1/2

**10-120 - 122**  
SEIDL  
10-120 80X8 mm  
10-121 80X10 mm  
10-122 90X14 mm  
For children and infants  
170 mm



1/2

**10-123**  
KRISTELLER  
70X15 mm, ( 170 mm )  
For children



1/2

**10-124 - 10-126**  
KRISTELLER  
10-124 70X27 mm  
10-125 75X30 mm  
10-126 90X36 mm  
175 mm





**Benodict**  
SURGICAL INSTRUMENTS

## Vaginal Specula- upper and lower blades



10-132 75X10 mm  
175 mm

10-136 70X15 mm  
175 mm

10-133 75X23 mm  
180 mm

10-137 70X27 mm  
180 mm

10-134 80X25 mm  
180 mm

10-138 75X30 mm  
180 mm

10-135 100X32 mm  
185 mm

10-139 90X36 mm  
185 mm

10-127 - 131  
KRISTELLER  
10-127 110X18 mm  
10-128 110X20 mm  
10-129 110X27 mm  
10-130 110X30 mm  
10-131 110X36 mm  
220 mm

10-132 - 10-135  
KRISTELLER  
Upper blades

10-136 - 10-139  
KRISTELLER  
Lower blades

Vaginal Specula





**Benodict**  
SURGICAL INSTRUMENTS

## Vaginal Retractors



1/2

**10-154**  
JOLL (FRIEDMAN)  
155 mm



1/2

**10-155**  
RICHTER  
170 mm



1/4



1/2

**10-156**  
GELPI  
135 mm

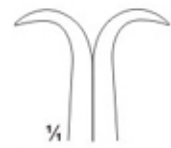

1/4



1/2

**10-157**  
GELPI  
175 mm

## Uterine Dilators



**11-101 - 143**  
HEGAR  
with very conical point  
185 mm

11-101	1	mm	11-123	23	mm
11-102	2	mm	11-124	24	mm
11-103	3	mm	11-125	25	mm
11-104	4	mm	11-126	26	mm
11-105	5	mm	11-127	1	½mm
11-106	6	mm	11-128	2	½mm
11-107	7	mm	11-129	3	½mm
11-108	8	mm	11-130	4	½mm
11-109	9	mm	11-131	5	½mm
11-110	10	mm	11-132	6	½mm
11-111	11	mm	11-133	7	½mm
11-112	12	mm	11-134	8	½mm
11-113	13	mm	11-135	9	½mm
11-114	14	mm	11-136	10	½mm
11-115	15	mm	11-137	11	½mm
11-116	16	mm	11-138	12	½mm
11-117	17	mm	11-139	13	½mm
11-118	18	mm	11-140	14	½mm
11-119	19	mm	11-141	15	½mm
11-120	20	mm	11-142	16	½mm
11-121	21	mm	11-143	17	½mm
11-122	22	mm			



**11-144 - 152**  
HEGAR  
205 mm

11-144	1+2	mm
11-145	3+4	mm
11-146	5+6	mm
11-147	7+8	mm
11-148	9+10	mm
11-149	11+12	mm
11-150	13+14	mm
11-151	15+16	mm
11-152	17+18	mm

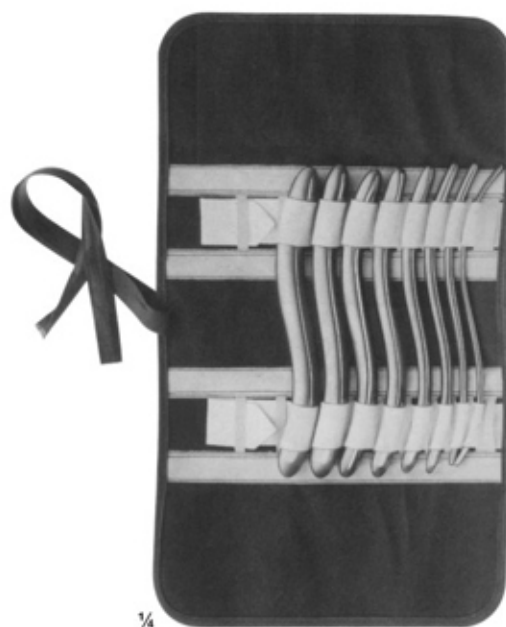

**11-153**  
HEGAR  
Uterine dilator set, in canvas  
roll with 8 dilators.



## Uterine Probes



**11-154**  
MAYO  
malleable  
330 mm



**11-155**  
SIMS  
malleable  
330 mm



**11-156**  
MARTIN  
330 mm



**11-157**  
SIMPSON  
malleable  
silver-plated  
290 mm



**11-158**  
BRAUN  
Uterine  
depressor  
270 mm



**11-159**  
Cotton  
applicator  
270 mm

## Uterine Dressing Forceps



Jaws with longitudinal groove

**Polypus-and Ovum Forceps**

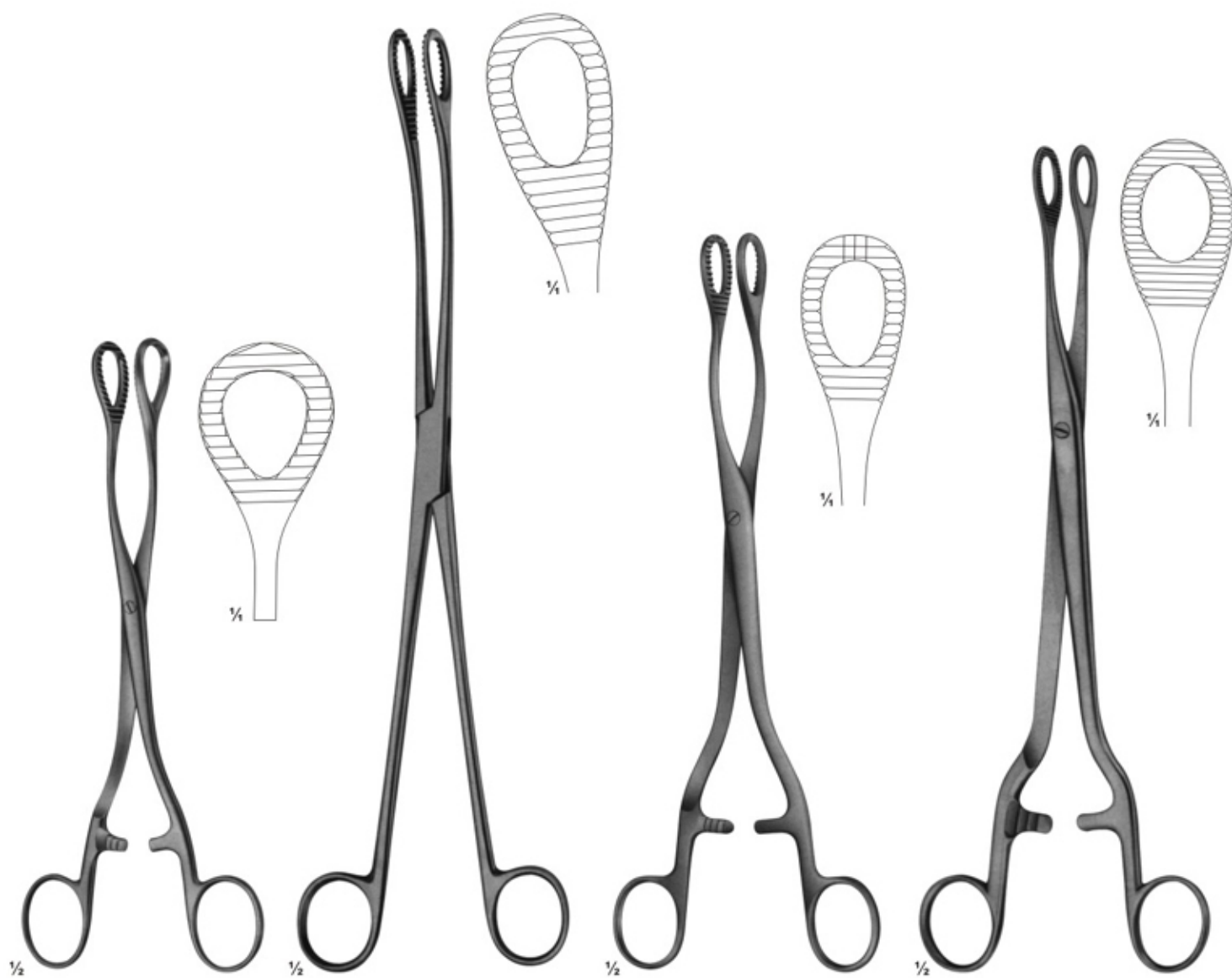

**11-164**  
HEYWOOD-SMITH  
200 mm

**11-165**  
KELLY  
320 mm

**11-166**  
HEYWOOD-SMITH  
250 mm

**11-167**  
NOTO  
280 mm

# Ear Currettes



**12-101**  
Langenbeck  
13 cm / 5 1/8"

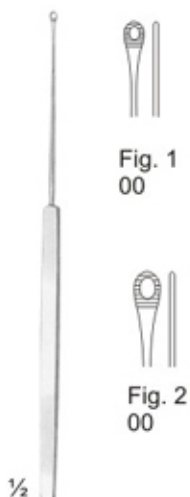

**12-102**  
Shapleigh  
15 cm / 5 1/8"

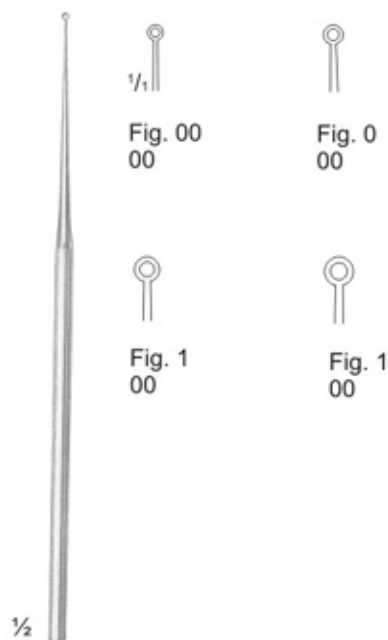

**12-103**  
Buck  
17cm / 6 6/8"



**12-104**  
Buck  
15 cm / 6 6/8"

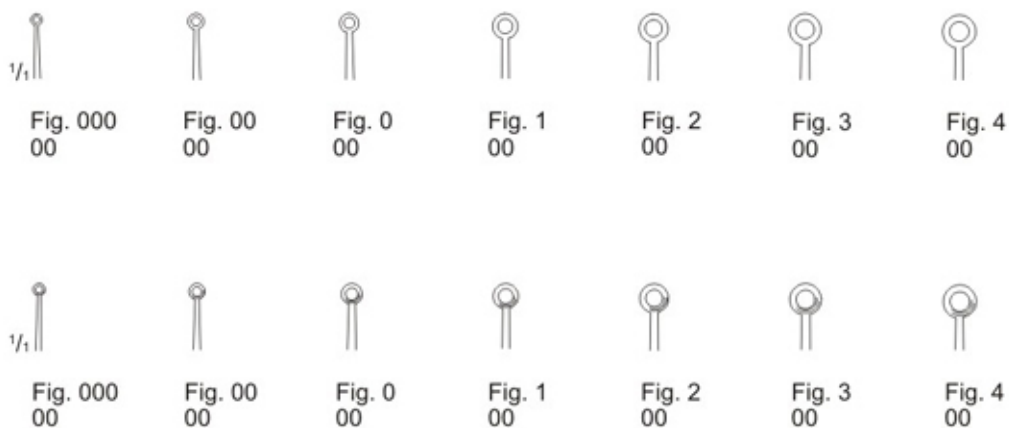



## Biopsy Curettes

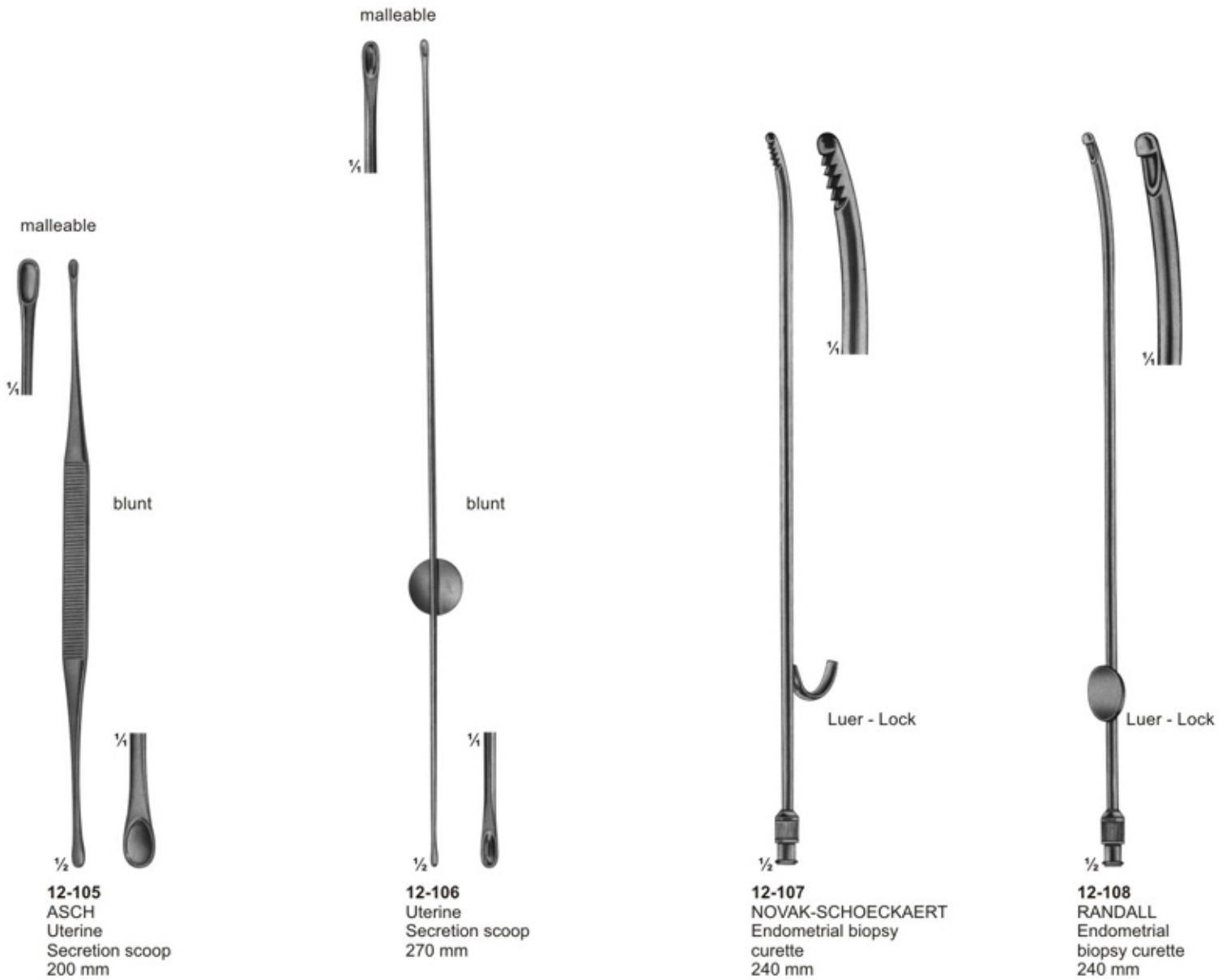

# Ear Polypus Forceps



**12-109**  
Hartmann-Wullstein  
shaft length  
85 mm

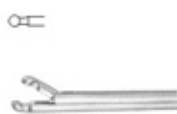

**12-110**  
Hartmann-Wullstein  
shaft length  
85 mm



**12-111**  
Hartmann  
shaft length  
85 mm



**12-112**  
Hartmann  
shaft length  
85 mm

1/1

**12-113**  
14 cm / 5 4/8"  
shaft length  
140 mm



1/2

**12-109 - 12-119**

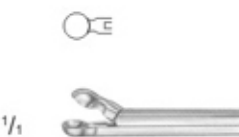

**12-114**  
Hartmann-Herzfelr  
2,0 mm  
shaft length  
85mm

1/1



**12-115**  
Hartmann  
3 mm  
shaft length  
85mm

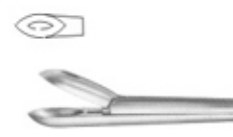

**12-116**  
shaft length  
85mm

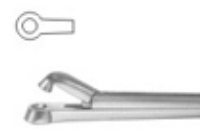

**12-117**  
Hartmann-Hoffmar  
2,0 mm  
85mm

**12-118**  
2,5 mm  
85 mm

**12-119**  
3,0 mm  
85 mm

# Biopsy forceps for rectum

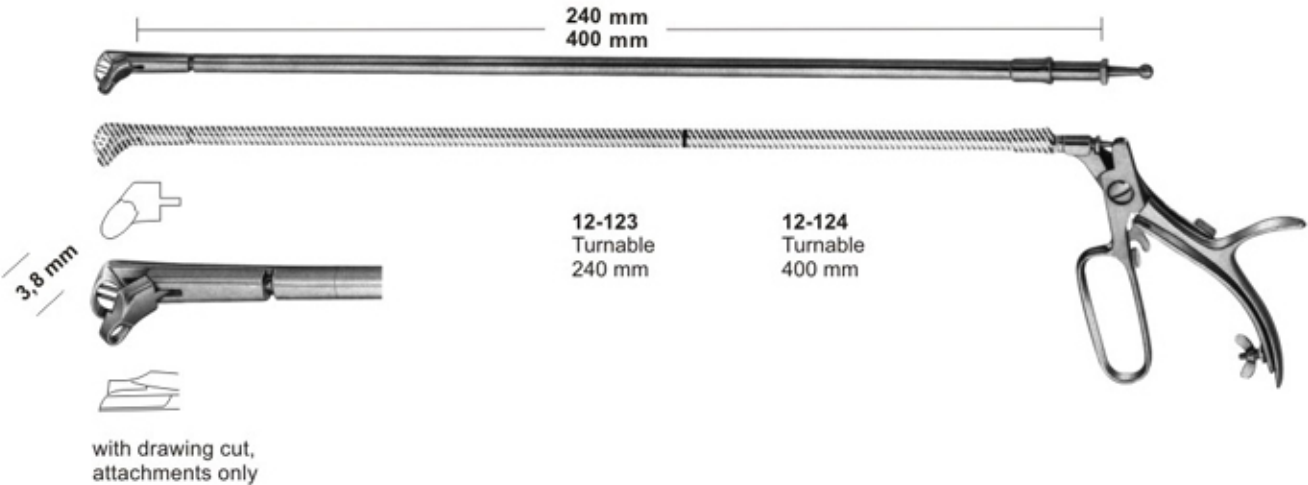
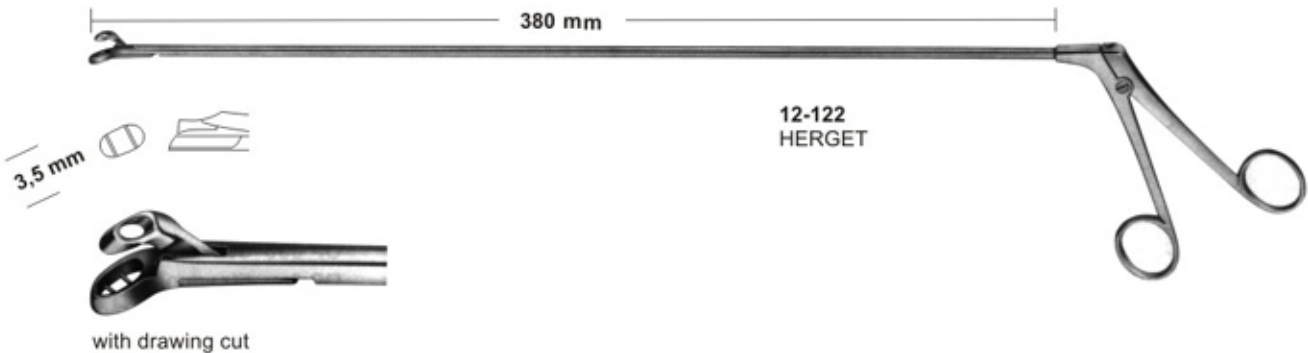
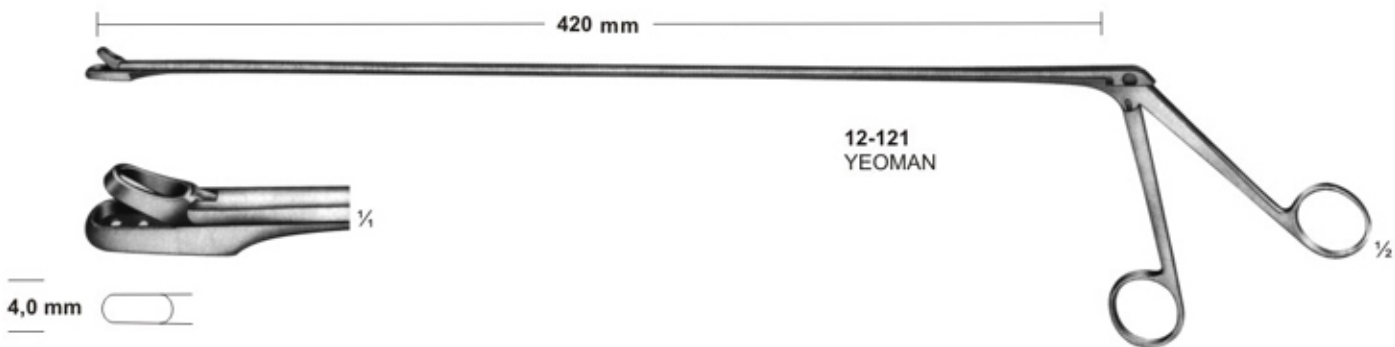
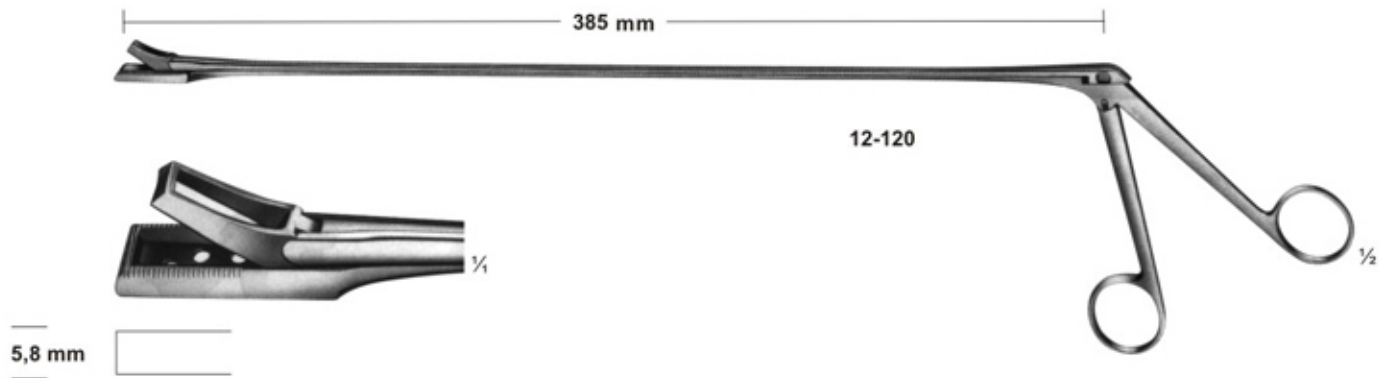



# Biopsy Forceps

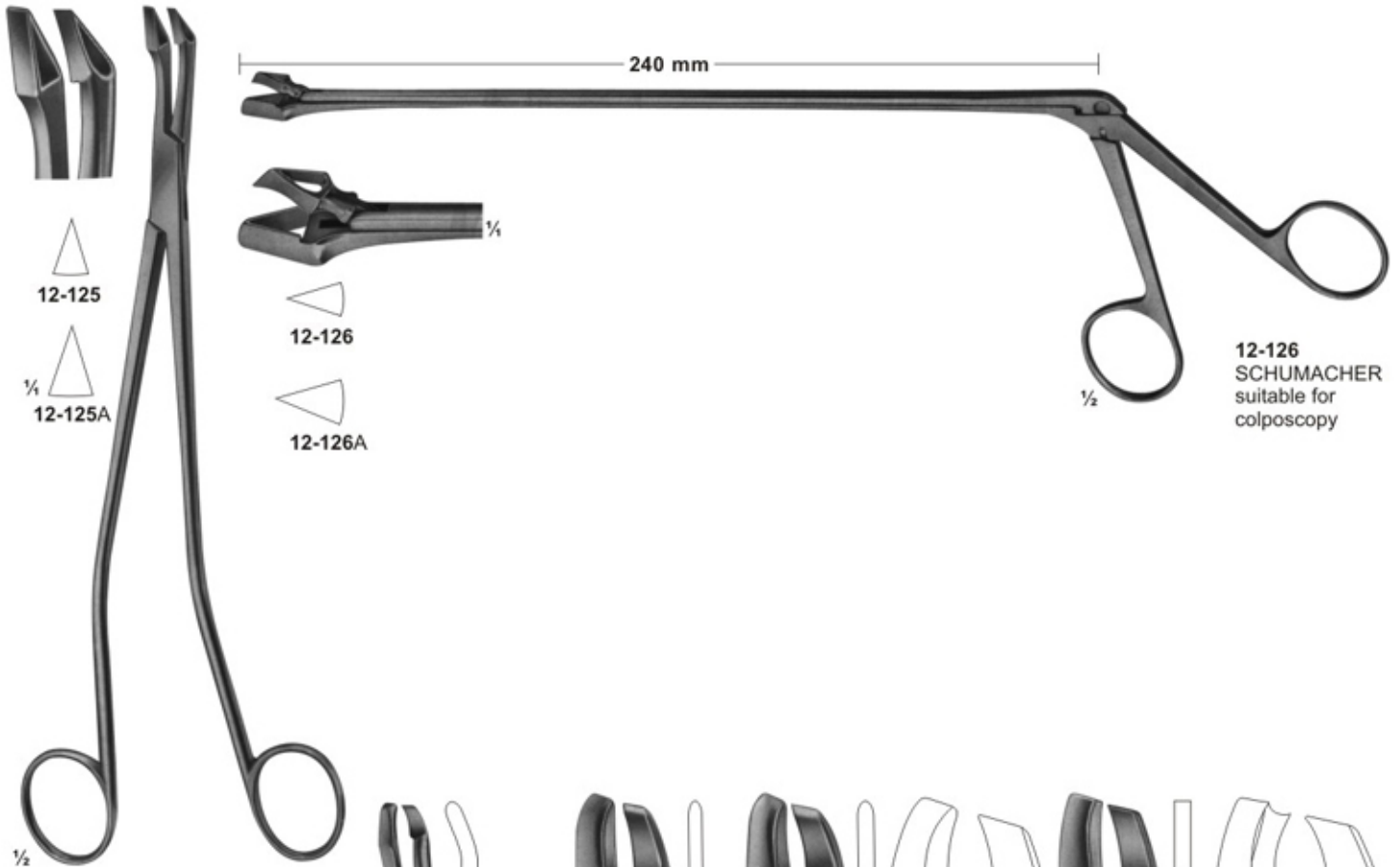

12-125

12-125A

12-126

12-126A

12-126  
SCHUMACHER  
suitable for  
colposcopy

12-125  
SCHUMACHER  
240mm

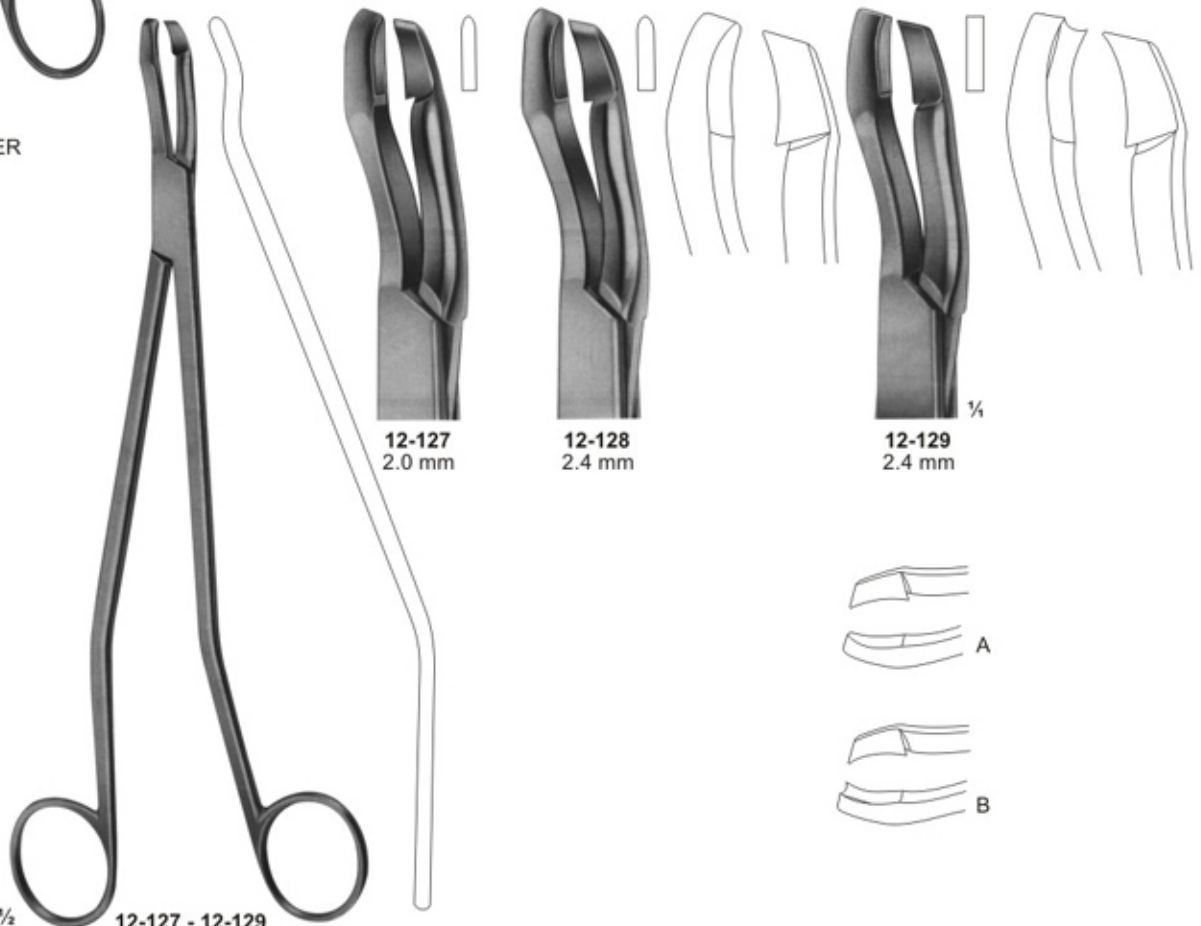

12-127  
2.0 mm

12-128  
2.4 mm

12-129  
2.4 mm

12-127 - 12-129  
SEIDL DBP  
Biopsy forceps, bayonet shaped  
for portio, vagina and vulva  
240mm

# Biopsy Forceps

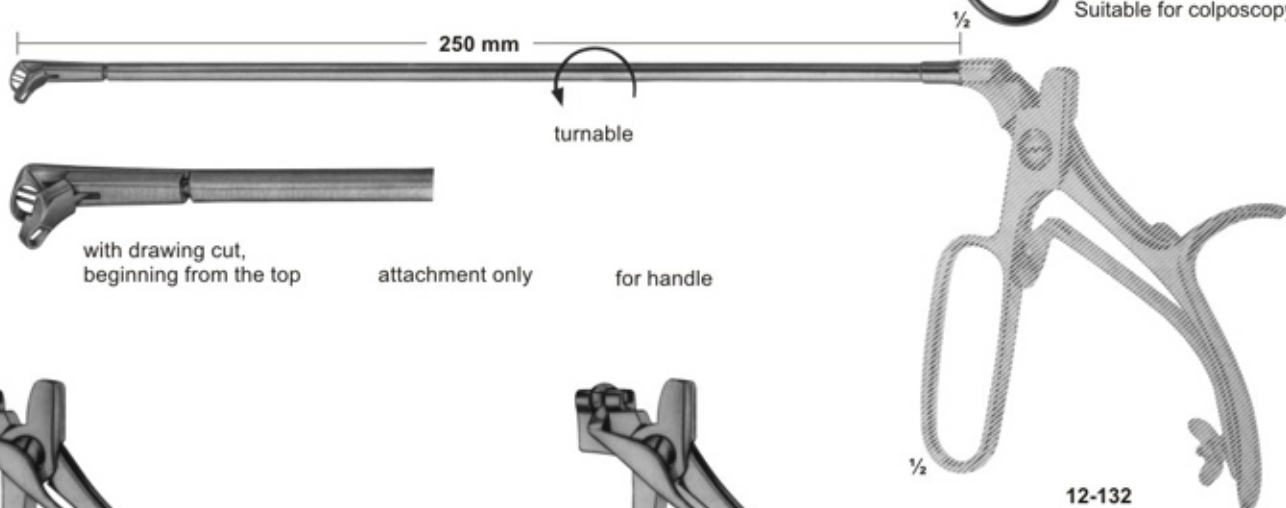
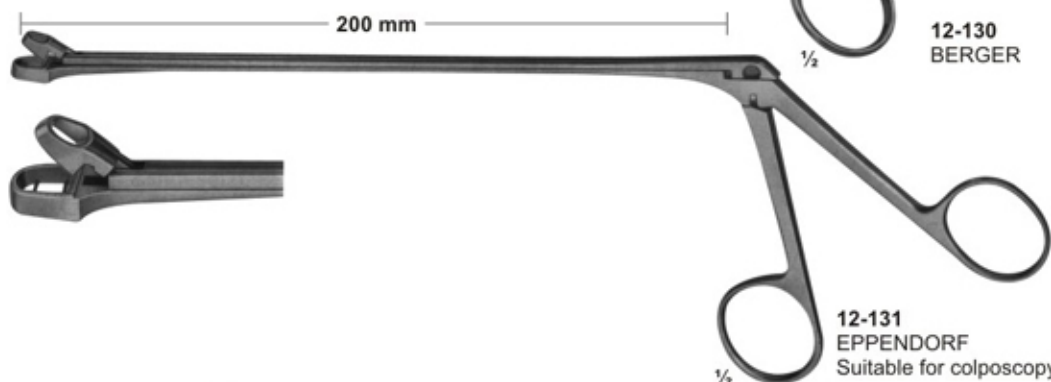
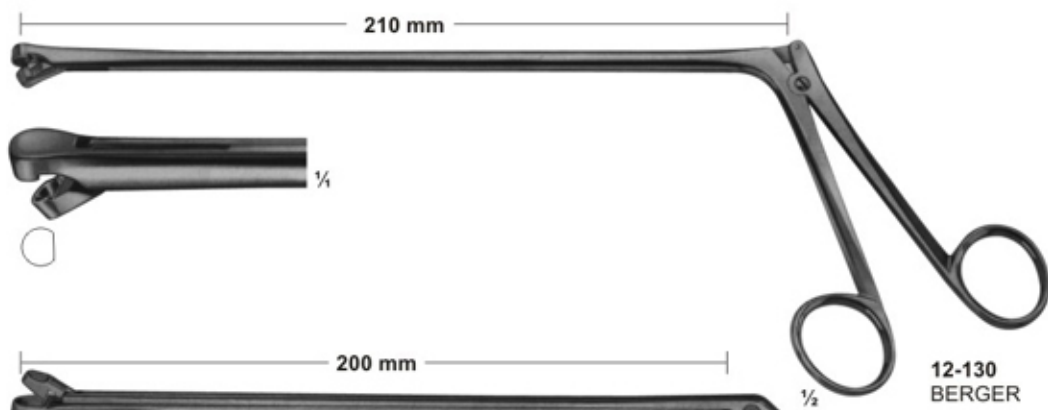

with drawing cut, beginning from the top      attachment only      for handle





# Uterine Scoops

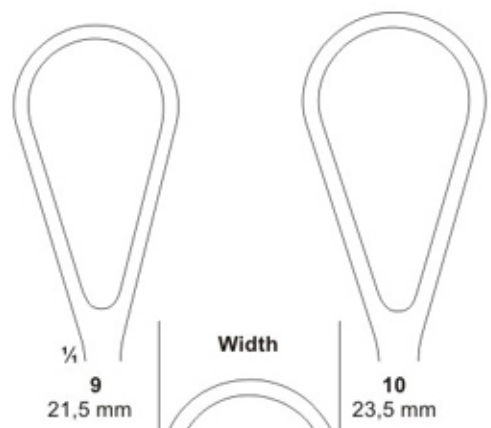
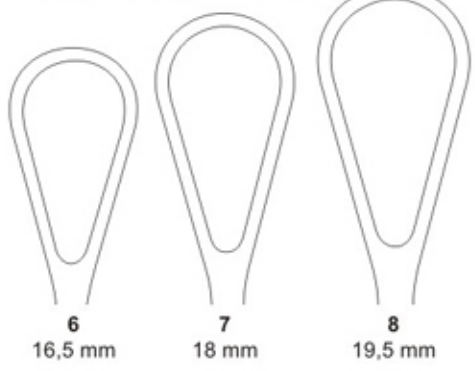
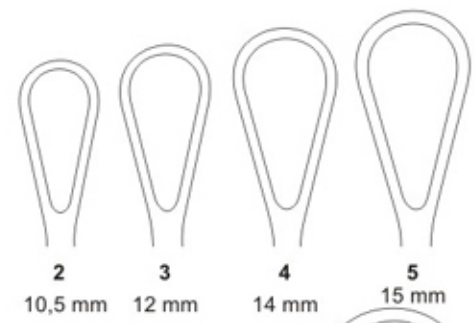
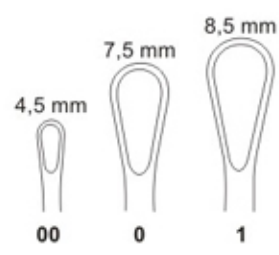

Width



12-140  
SIMON  
240 mm

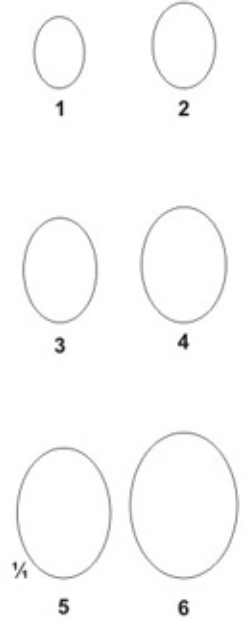

12-141  
SCHROEDER  
310 mm

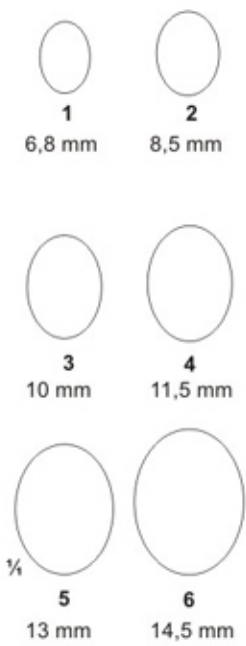

12-142  
RECAMIER  
300 mm

**Obstetrical Forceps**



1/3

**13-101**  
NAEGELE  
355 mm



1/3

**13-102**  
NAEGELE  
400 mm



1/3

**13-103**  
SIMPSON-BRAUN  
305mm

# Obstetrics- Placenta and Ovum Forceps

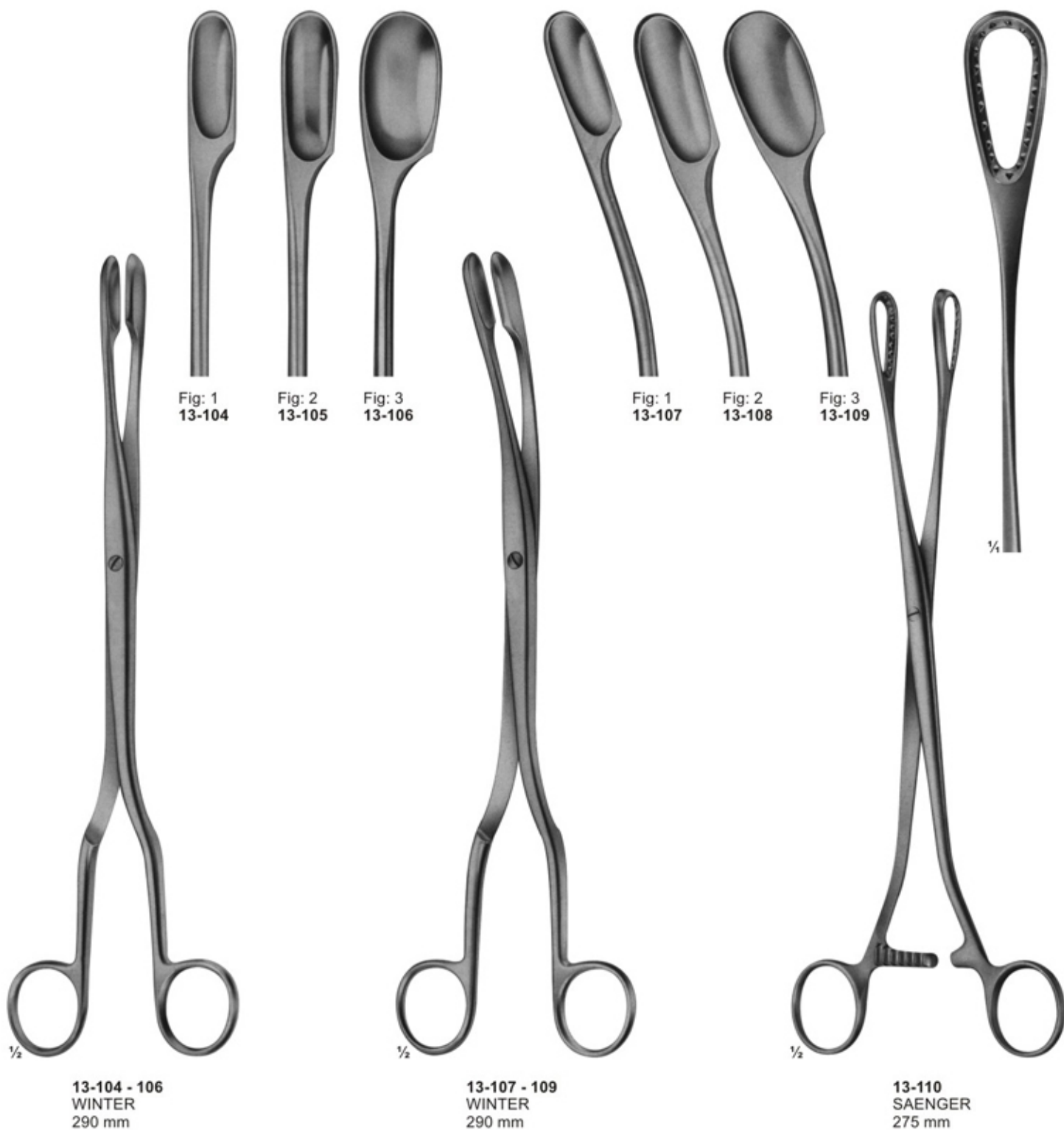

## Tound-and Tracheal Hooks and Dilators

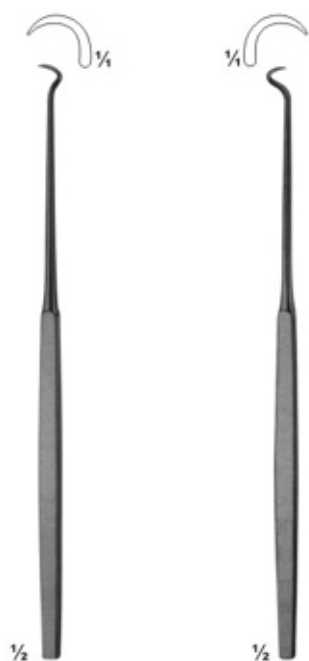

13-111  
BOSE  
165 mm

13-112  
BOSE  
165 mm



13-113 - 115  
180 mm

13-113  
sharp



13-114  
blunt



13-115  
stumpf/blunt



13-116  
FINSEN  
50 mm



13-117  
FINSEN  
70 mm



13-118  
TROUSSEAU  
120 mm



13-119  
LABORDE  
125 mm



13-120  
LABORDE  
strong pattern  
135 mm



13-121  
Cleaning Brush  
for tracheal tubes  
285 mm

# Vascular Spatulas

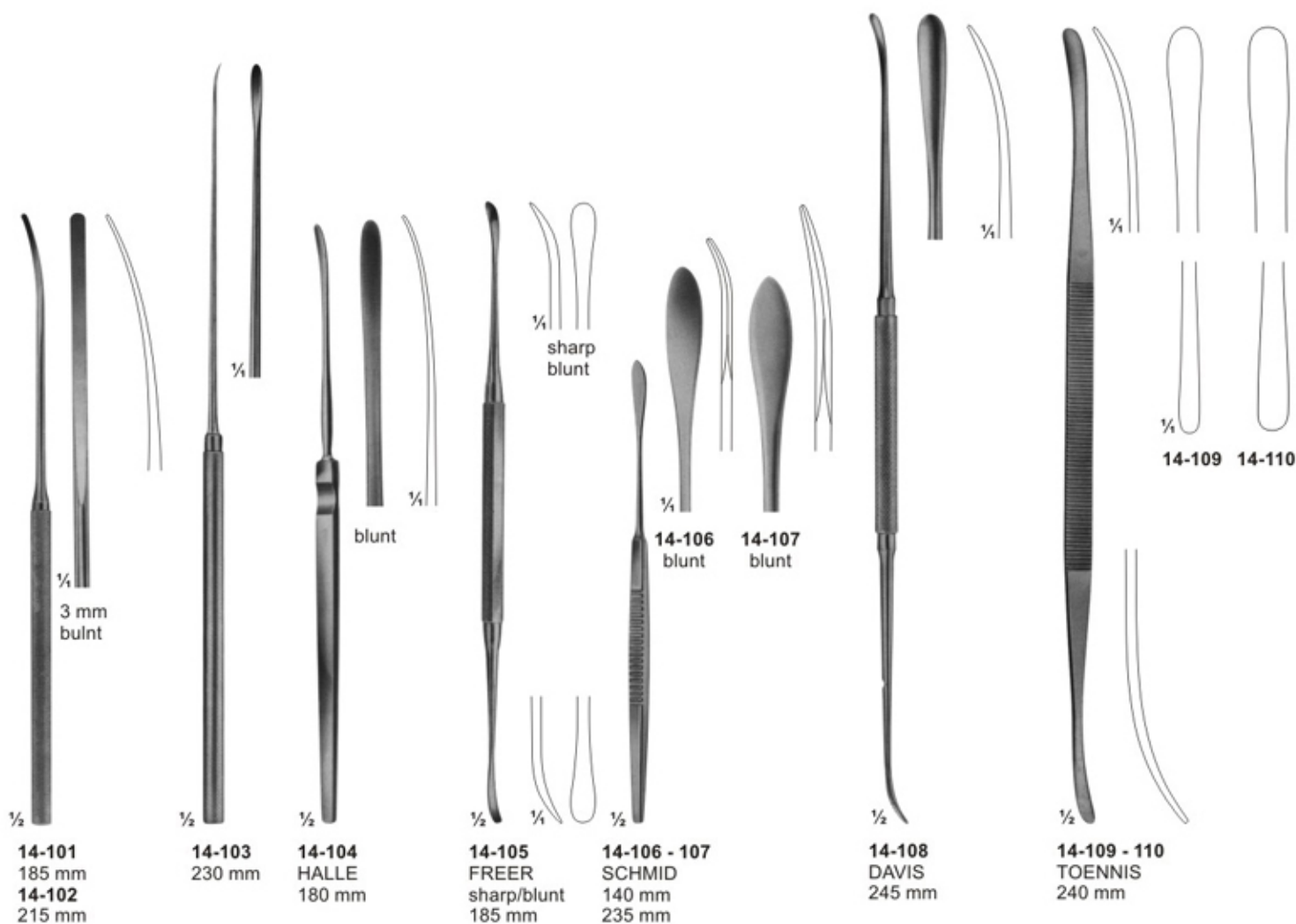





**ATRAUMATA**  
**Forceps**

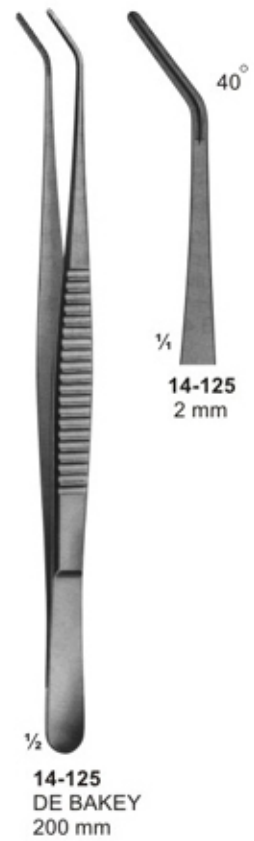
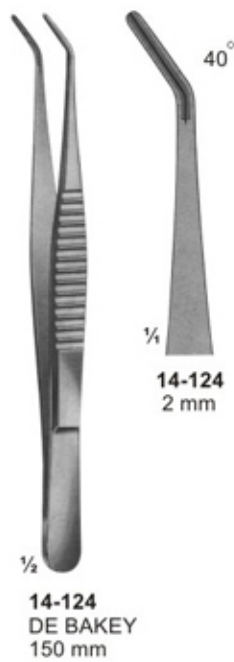
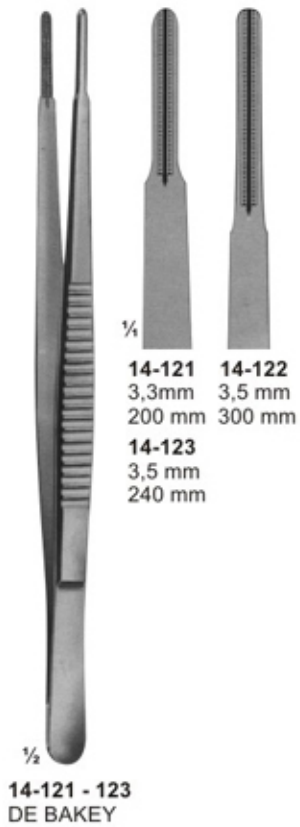
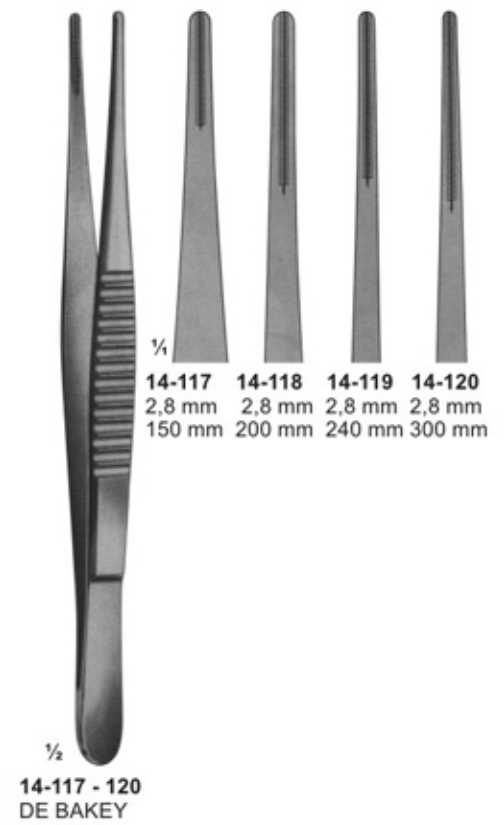
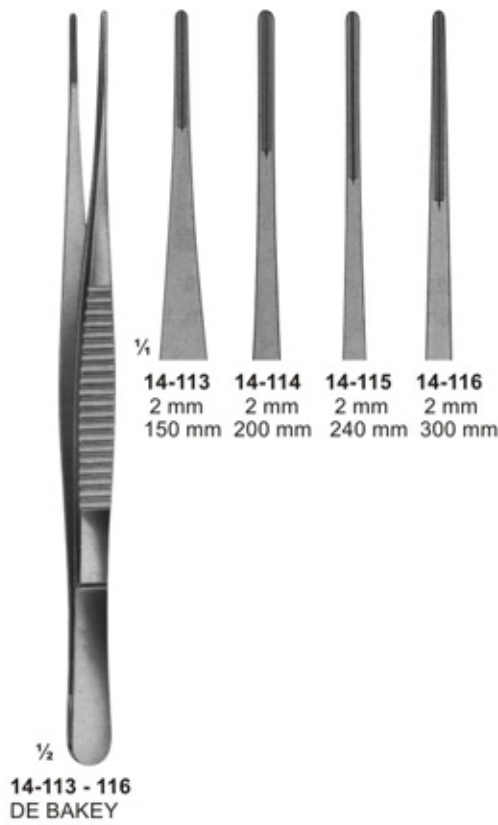
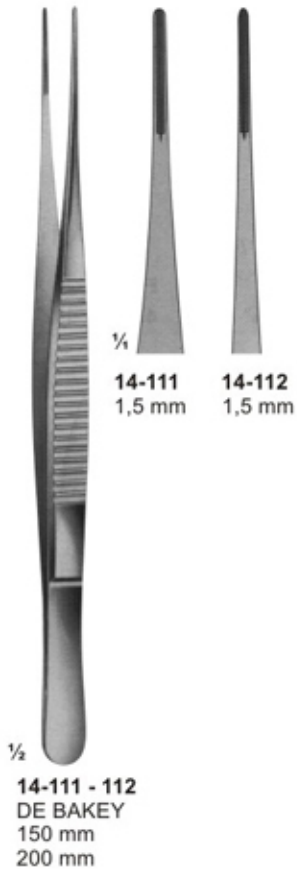



**Benodict**  
SURGICAL INSTRUMENTS

# ATRAUMATA

## Anastomosis- and Multi- Purpose- Clamps- Pediatric types

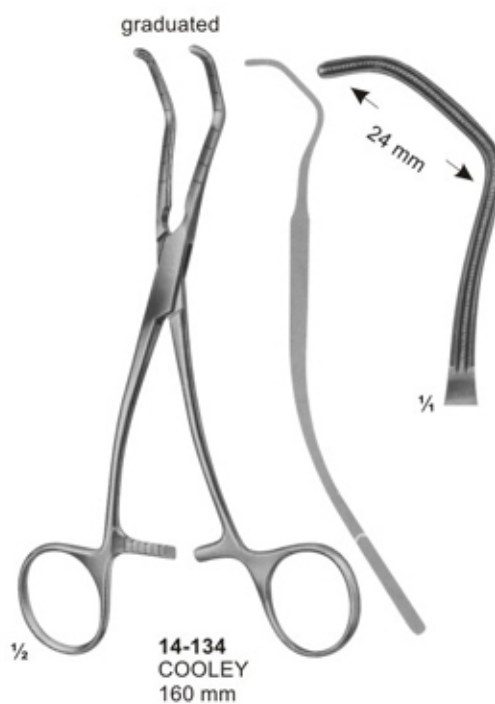
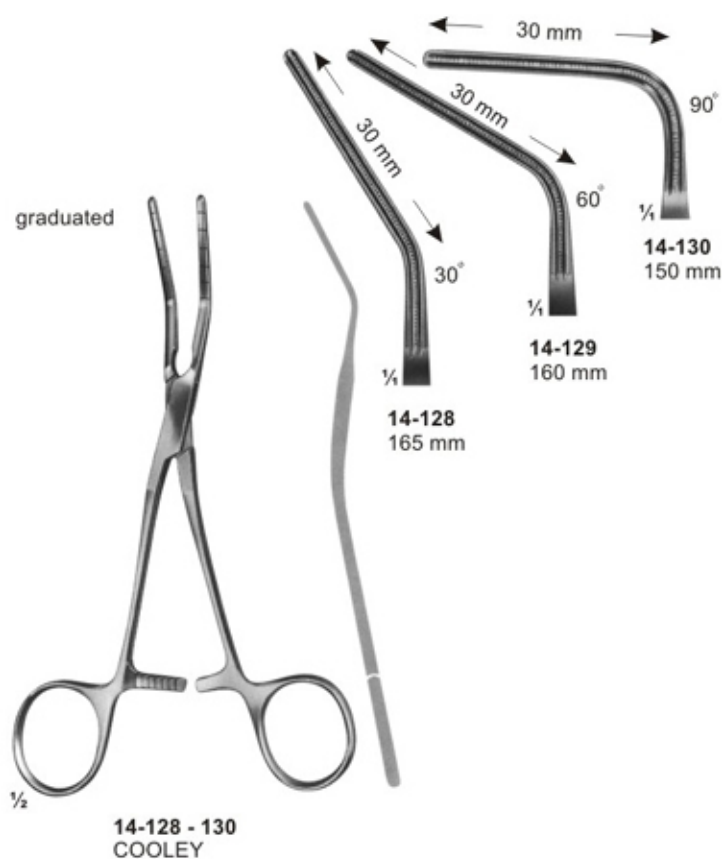
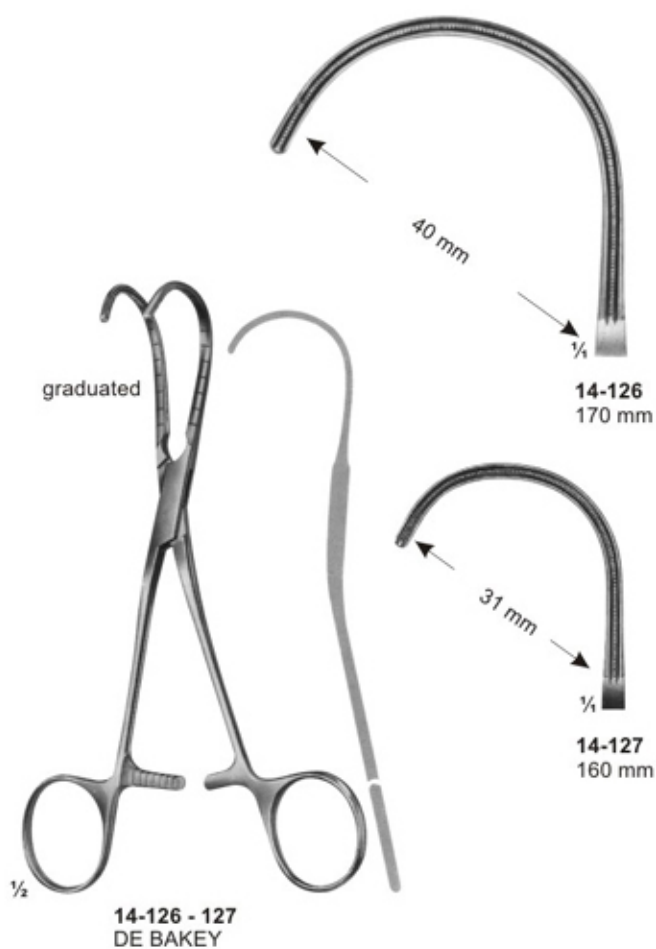



**Benodict**  
SURGICAL INSTRUMENTS

## ATRAUMATA

### Coarctation Clamps, Patent-Ductus & Peripheral-Vascular Clamps

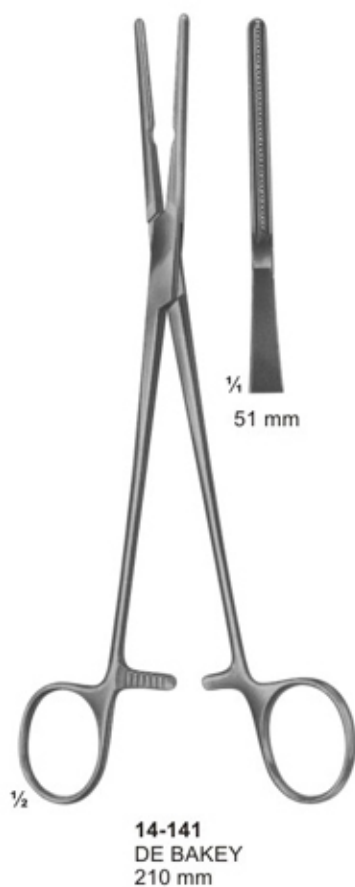
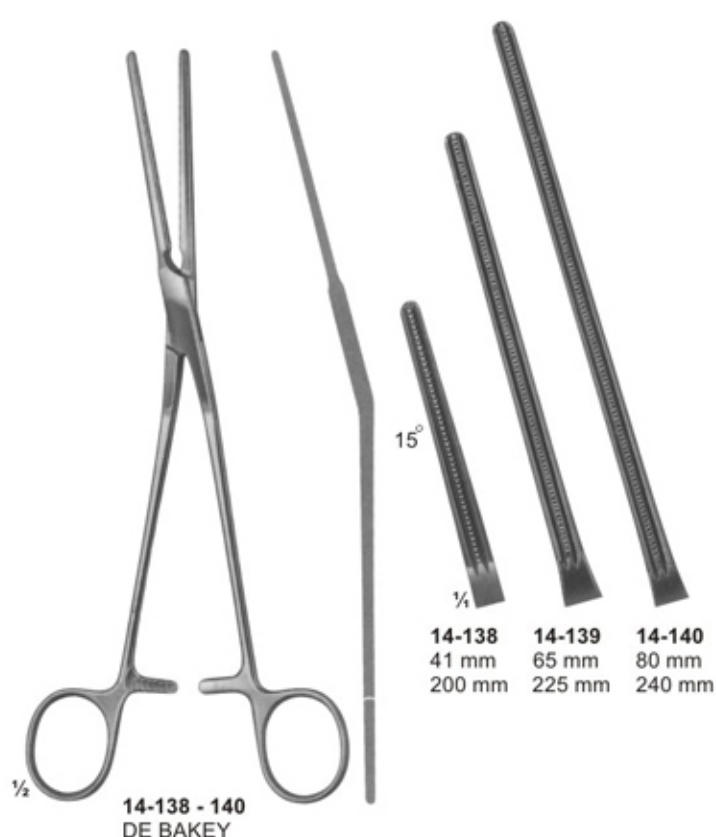
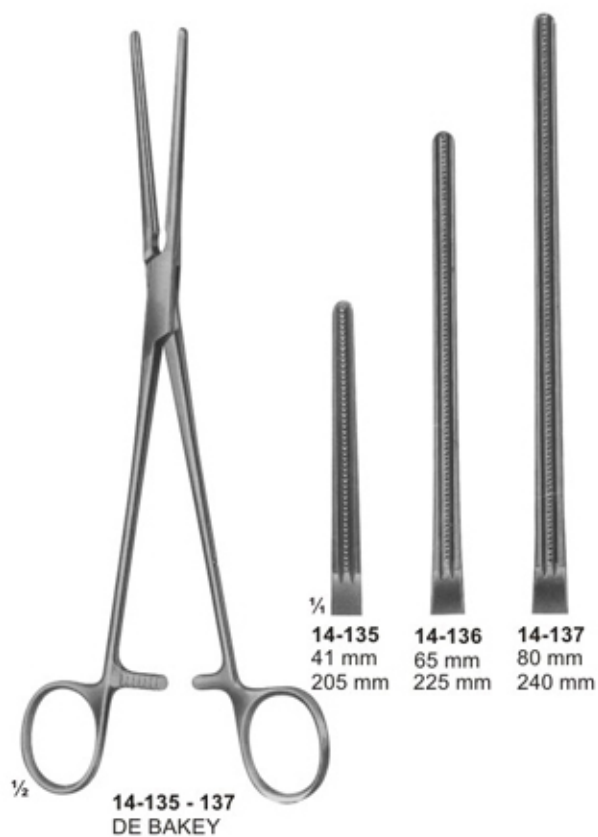

## Aorta- Anastomosis Clamps



**L**  
**14-144**  
**WEBER**  
**260 mm**



**R**  
**14-145**  
**WEBER**  
**260 mm**



# Multi- Purpose-Clamps



1/2 **14-146 - 149**  
DE BAKEY

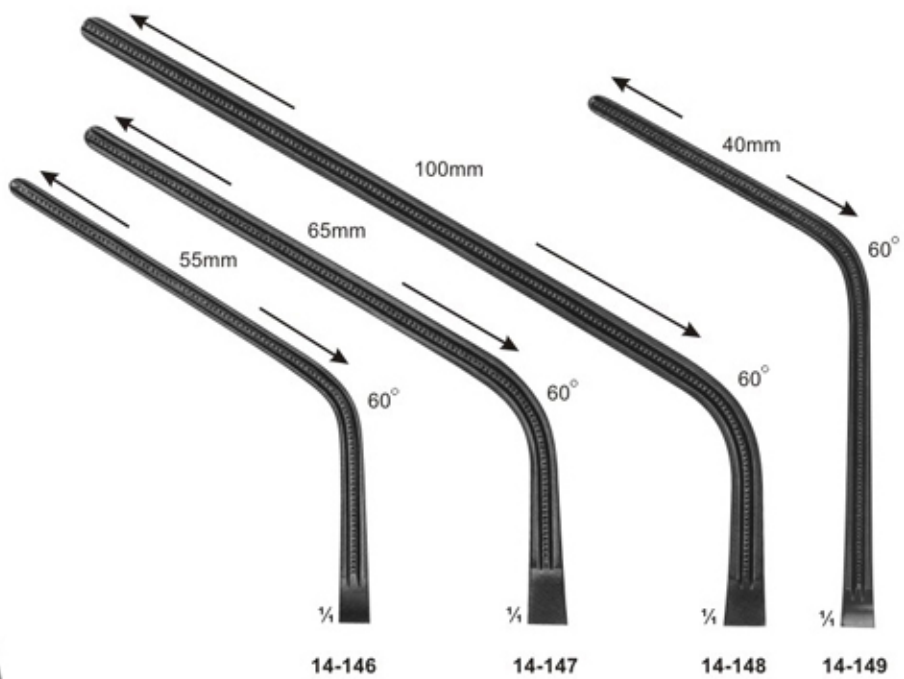

Total Length:	230 mm	280 mm	305 mm	240 mm
Length of jaws:	85 mm	100 mm	135 mm	93 mm



1/2 **14-150 - 153**  
DE BAKEY

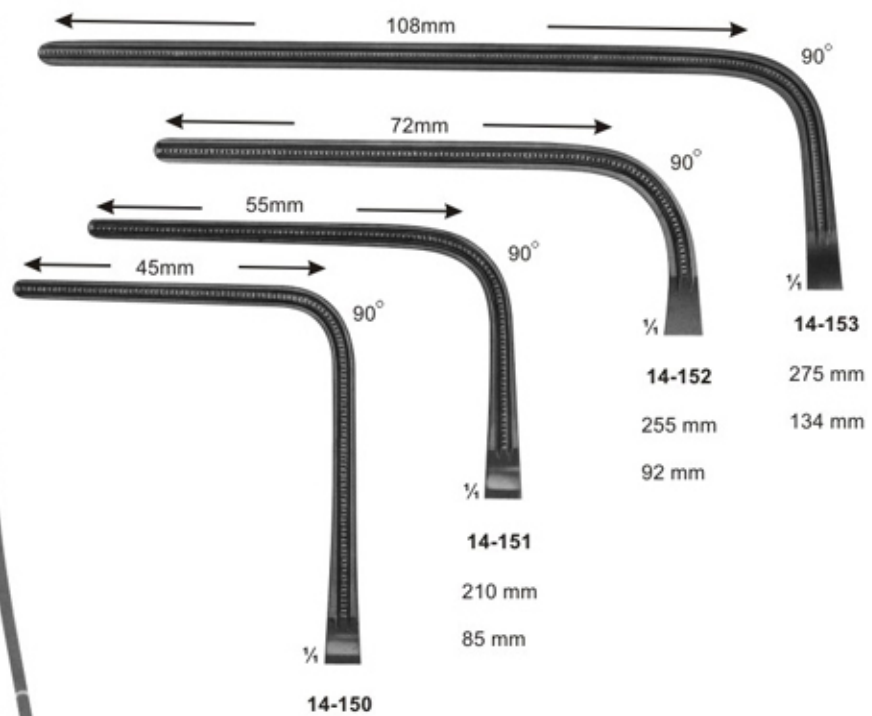

Total Length:	225 mm	275 mm	255 mm	134 mm
Length of jaws:	93 mm	210 mm	92 mm	85 mm



## Sternum Instruments and Rib Shears



14-154  
SCHUMACHER  
Sternum shears  
210 mm



14-155  
LEBSCHKE  
Sternum chisel  
200 mm



14-156  
230 mm



14-157  
COLLIN  
195 mm



14-158  
GLUCK  
190 mm



14-159  
BETHUNE  
340 mm



14-160  
BRUNNER  
Universal pattern  
340 mm



14-161  
GIERTZ-STILLE  
250 mm

## Rib Spreaders

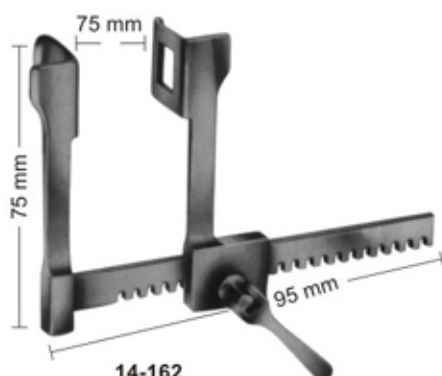

**14-162**  
FINOCHIETTO  
Blades  
18X21 mm

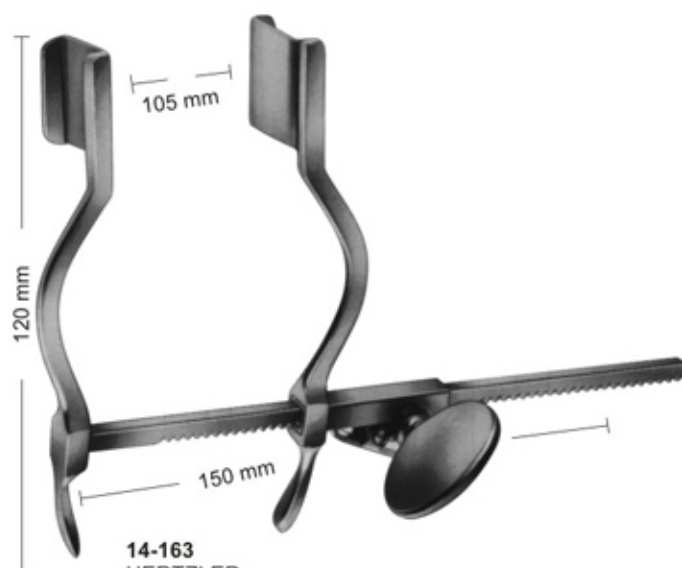

**14-163**  
HERTZLER  
Blades  
20X25 mm

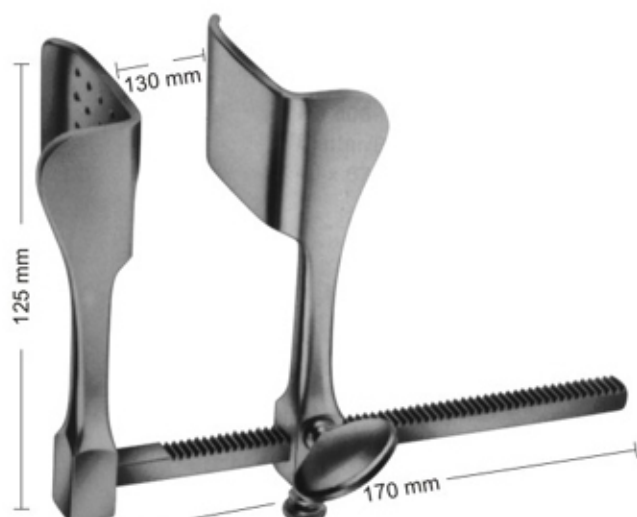

**14-164**  
TUFFIER  
Blades  
43X53 mm

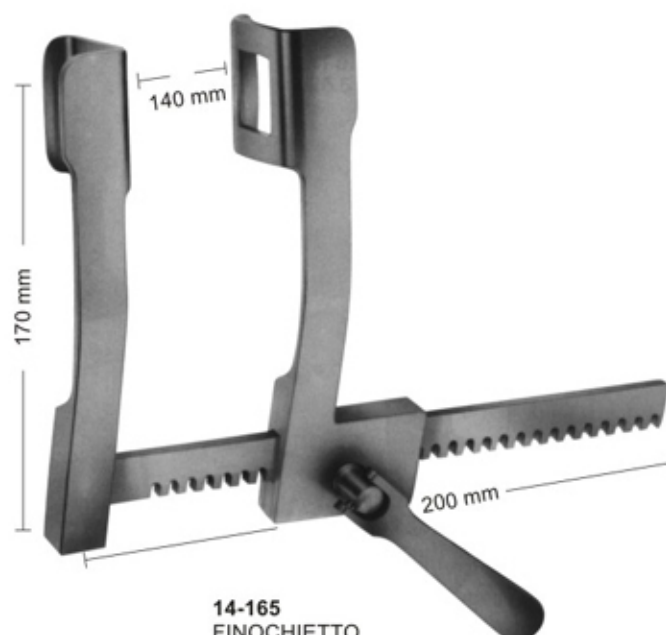

**14-165**  
FINOCHIETTO  
Blades  
36X45 mm

## Rib Spreaders-and Contractors



**14-166**  
**SELLORS**  
Rib spreader-and contractor  
with swivel blades  
200 mm



**14-167**  
**BAILEY**  
150 mm



**14-168**  
for children

**14-169**  
for adults

**14-168 - 169**  
**BAILEY**  
200 mm

# Punches

**130°** upwards cutting

**15-101**  
1 mm



KERRISON - JACOBY

FERRIS-SMITH-KERRISON

**15-102**  
2 mm



**15-103**  
3 mm



**15-104**  
4 mm



**15-105**  
5 mm

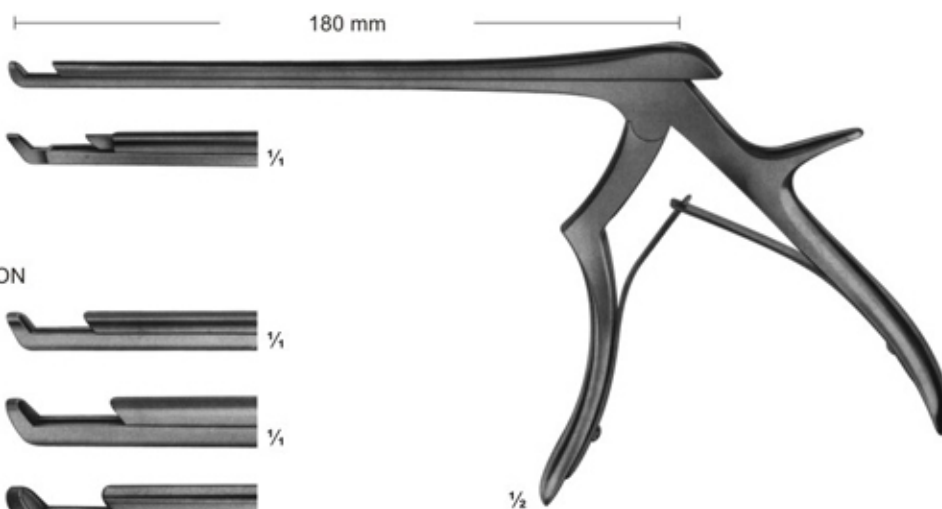

15-101 - 105

**90°** upwards cutting

KERRISON - JACOBY

**15-106**  
1 mm



**15-107**  
2 mm



FERRIS-SMITH-KERRISON

**15-108**  
3 mm



**15-109**  
4 mm



**15-110**  
5 mm

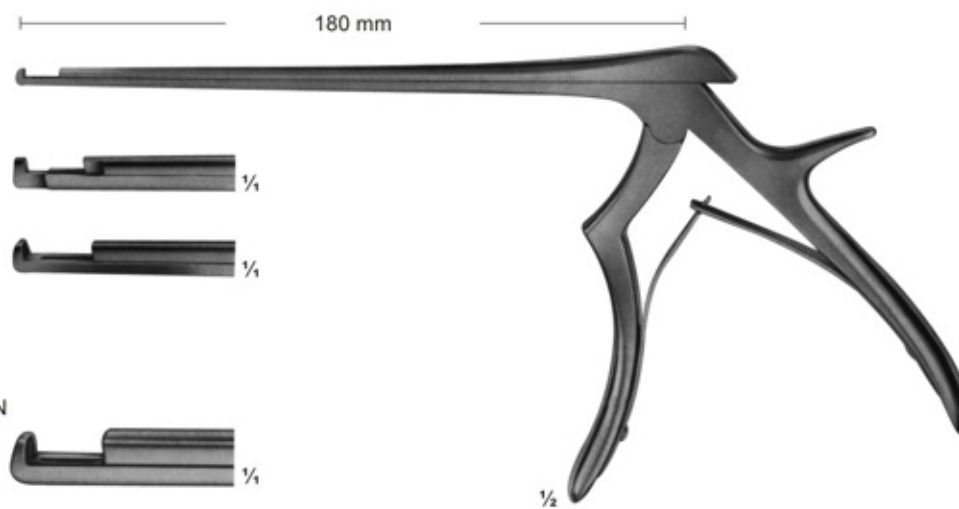

15-106 - 110

# Punches

90° upwards cutting

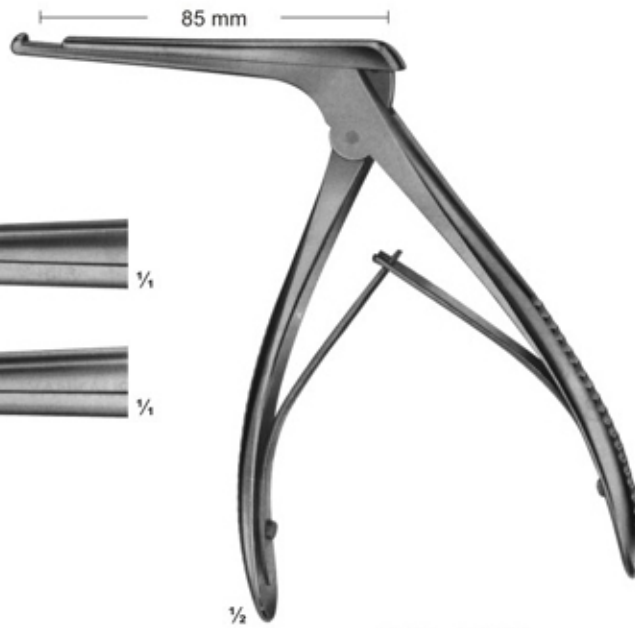

15-111  
4 mm



1/4

15-112  
5 mm



1/4

15-111 - 15-112  
KERRISON

90° upwards cutting

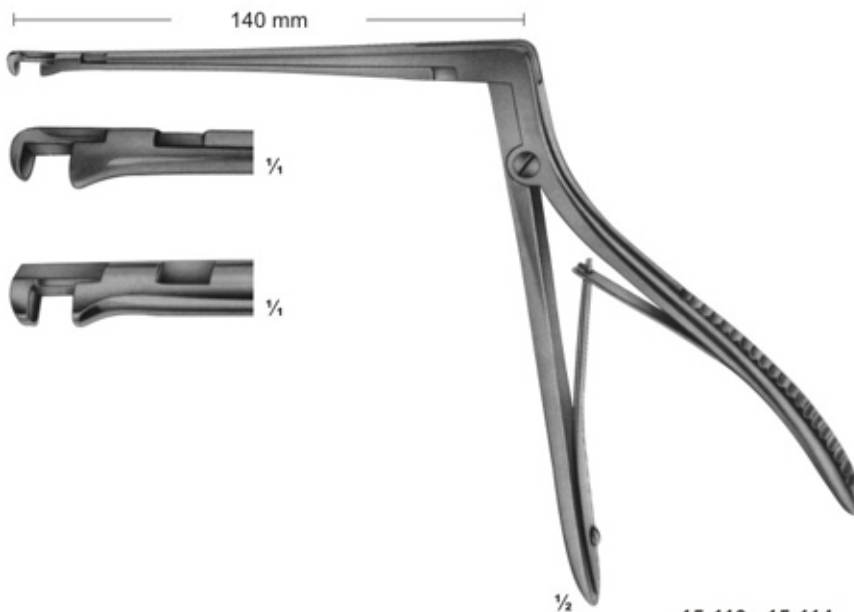

15-113  
3,3 mm



1/4

15-114  
4,0 mm



1/4

15-113 - 15-114  
HAJEK-KOFLER



**Rongeurs**

**LOVE-GRUENWALD**

**15-115**  
2 X 10 mm

**15-116**  
3 X 10 mm

**SPURLING**  
**15-117**  
4 X 10 mm



15-115 - 15-117

**15-118**  
2 mm

**15-119**  
3 mm

**15-120**  
4 mm

**15-121**  
5 mm

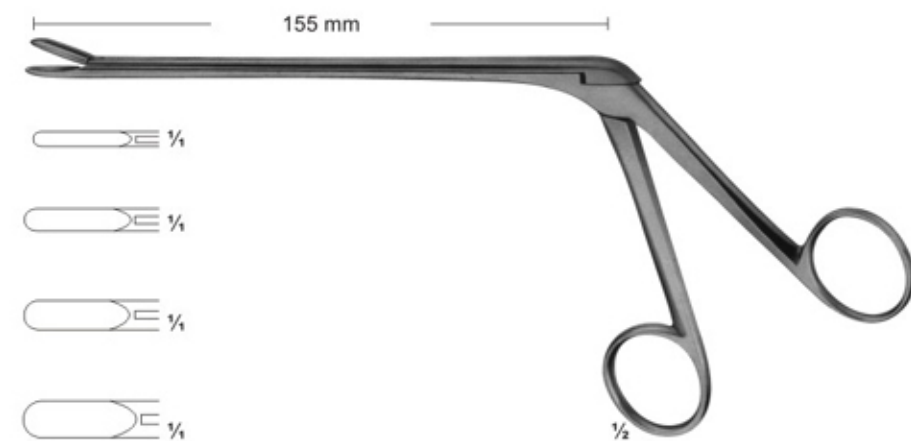

15-118 - 15-121  
CASPAR

**150°**

**15-122**  
2 mm

**15-123**  
3 mm

**15-124**  
4 mm

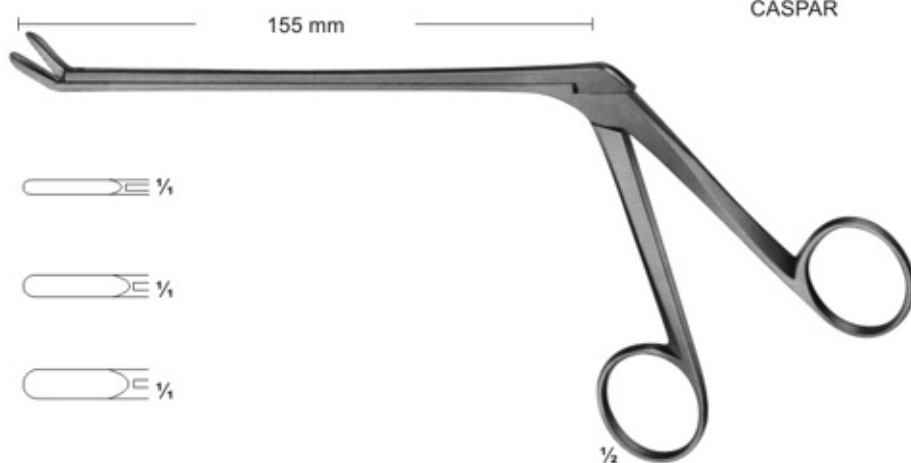

15-122 - 15-124  
CASPAR

# Rongeurs

Angled positions for rongeurs

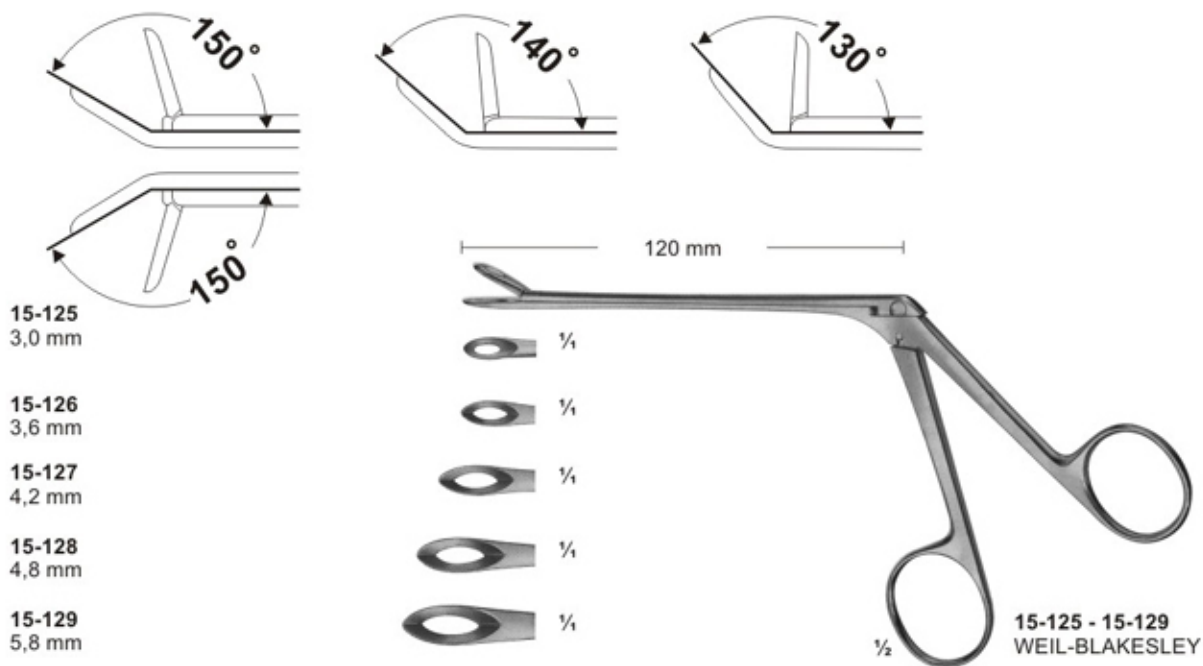

15-125  
3,0 mm

15-126  
3,6 mm

15-127  
4,2 mm

15-128  
4,8 mm

15-129  
5,8 mm

120 mm

1/4

1/4

1/4

1/4

1/4

1/2

15-125 - 15-129  
WEIL-BLAKESLEY

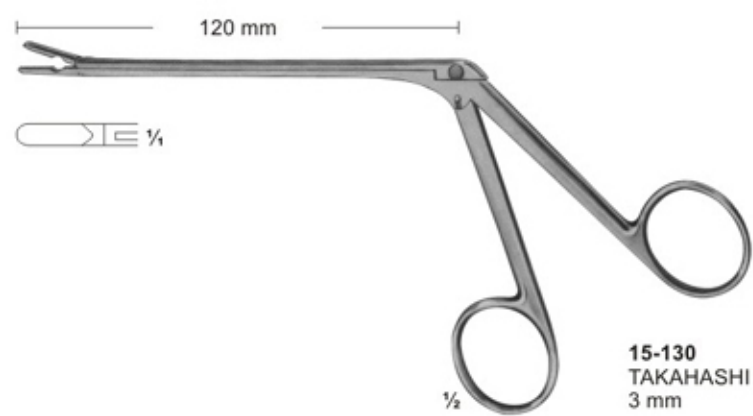

120 mm

1/4

1/2

15-130  
TAKAHASHI  
3 mm

130°

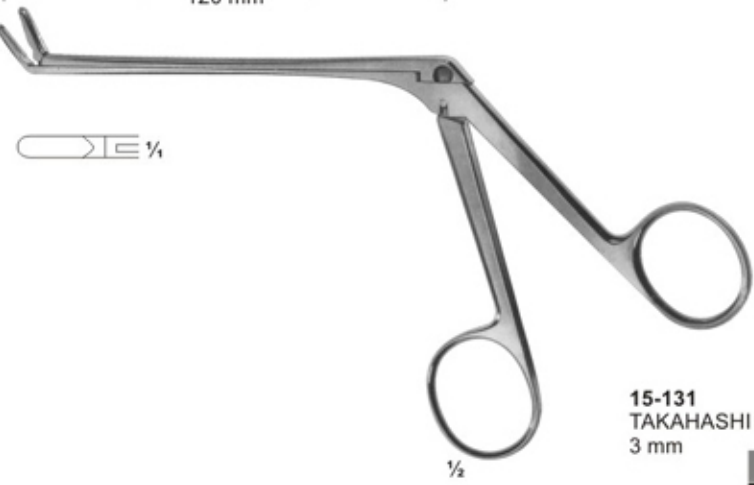

120 mm

1/4

1/2

15-131  
TAKAHASHI  
3 mm

# Rongeurs

**150°**

Lower part of jaws movable

**15-132**  
2 mm

**15-133**  
3 mm

**15-134**  
4 mm

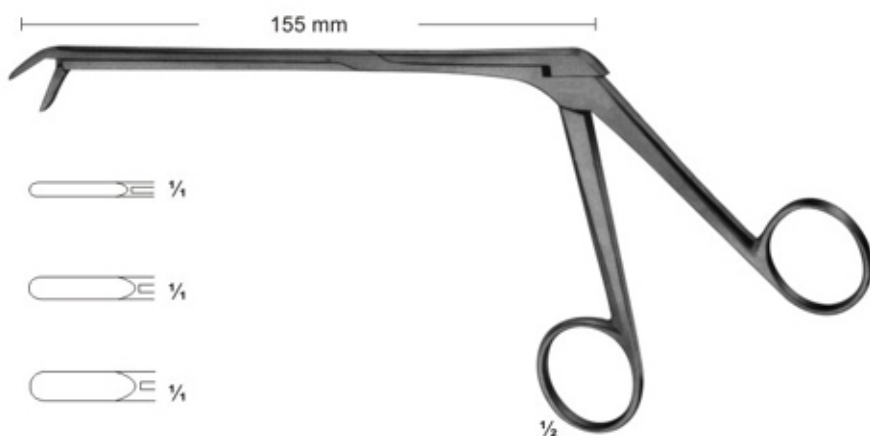

**15-132 - 15-134**  
CASPAR

Length of shaft 140 mm	Length of shaft 160 mm	Length of shaft 185 mm	size of jaws
<b>15-135</b>	<b>15-140</b>	<b>15-145</b>	2 X 12 mm
<b>15-136</b>	<b>15-141</b>	<b>15-146</b>	3 X 12 mm
<b>15-137</b>	<b>15-142</b>	<b>15-147</b>	4 X 14 mm
<b>15-138</b>	<b>15-143</b>	<b>15-148</b>	5 X 14 mm
<b>15-139</b>	<b>15-144</b>	<b>15-149</b>	6 X 16 mm

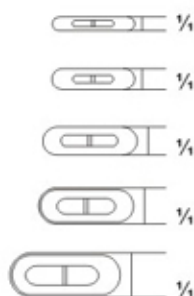

**15-135 - 15-149**  
CASPAR

**150°**

Length of shaft 140 mm	Length of shaft 160 mm	Length of shaft 185 mm	size of jaws
<b>15-150</b>	<b>15-153</b>	<b>15-156</b>	3 X 12 mm
<b>15-151</b>	<b>15-154</b>	<b>15-157</b>	4 X 14 mm
<b>15-152</b>	<b>15-155</b>	<b>15-158</b>	5 X 14 mm

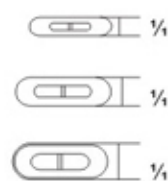

**15-150 - 15-158**  
CASPAR

**Rongeurs**

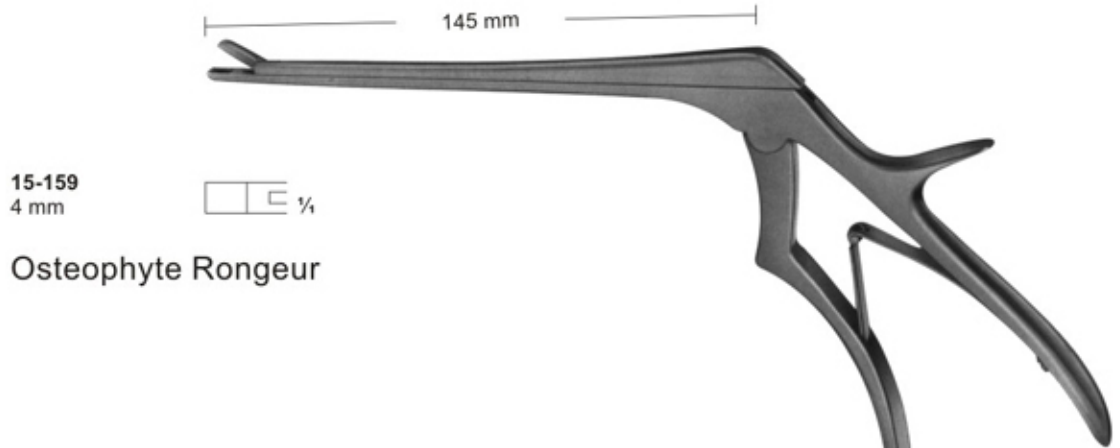

**15-159**  
4 mm



Osteophyte Rongeur

1/2

**15-159**  
CASPAR

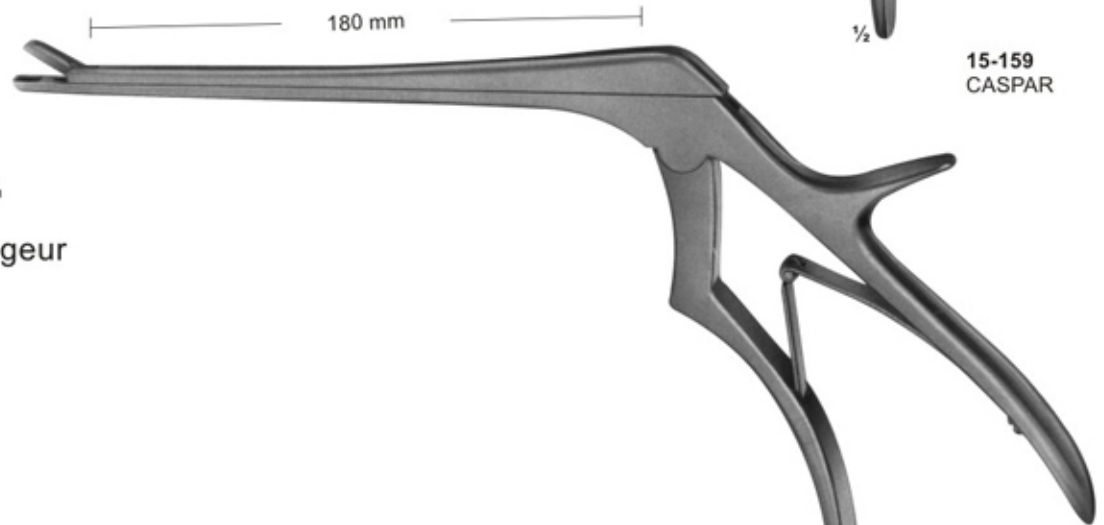

**15-160**  
4 mm



Osteophyte Rongeur

1/2

**15-160**  
CASPAR

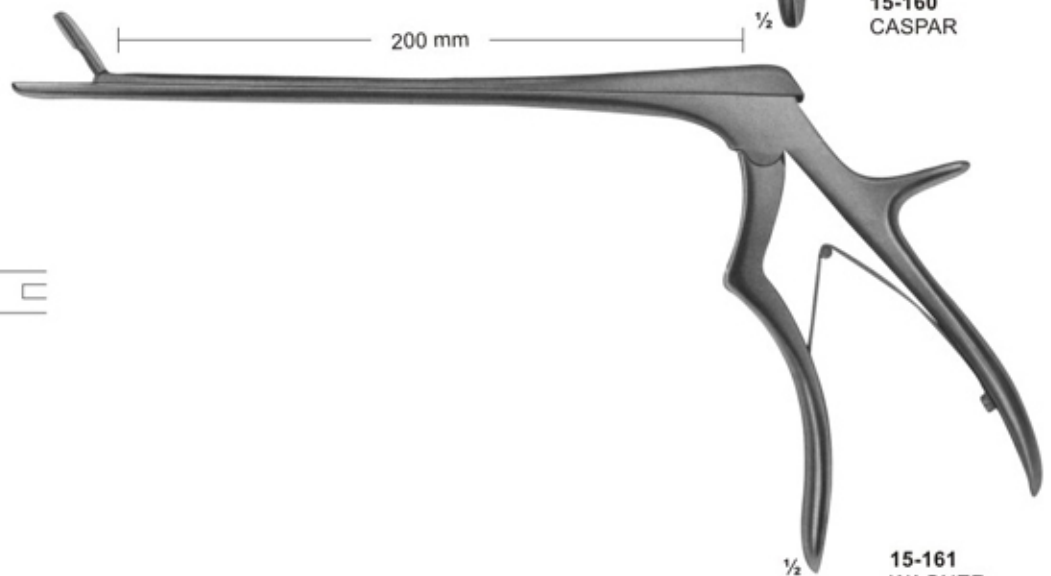

**15-161**  
5,5 mm



Very Heavy Pattern

1/2

**15-161**  
WAGNER

## Elevators and Bone Levers

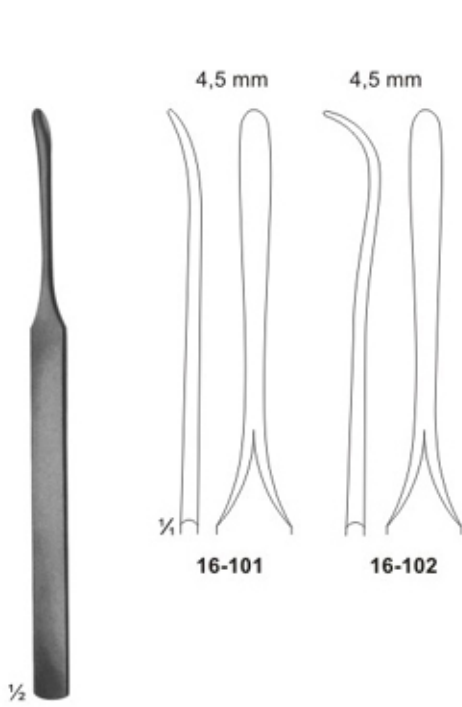

**16-101 - 102**  
KONIG  
155 mm



**16-103**  
WILLIGER  
165 mm

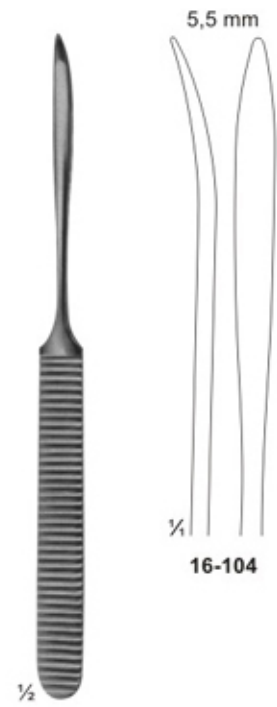

**16-104**  
WILLIGER  
170 mm

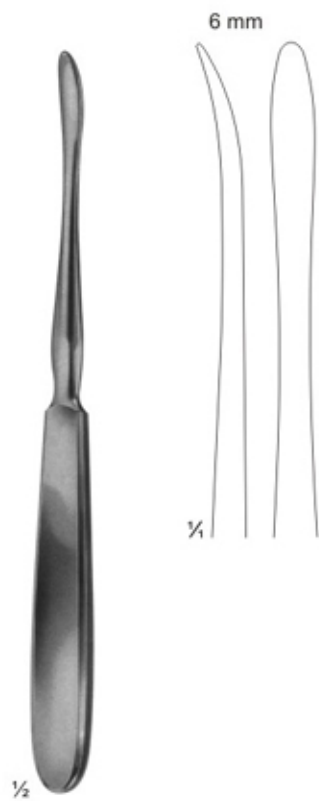

**16-105**  
QUERVAIN  
195 mm

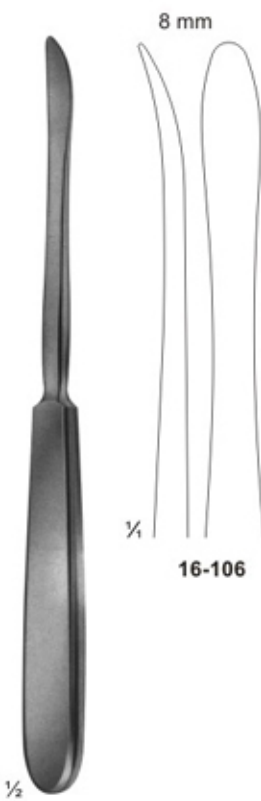

**16-106 - 107**  
LANGENBACK  
195 mm

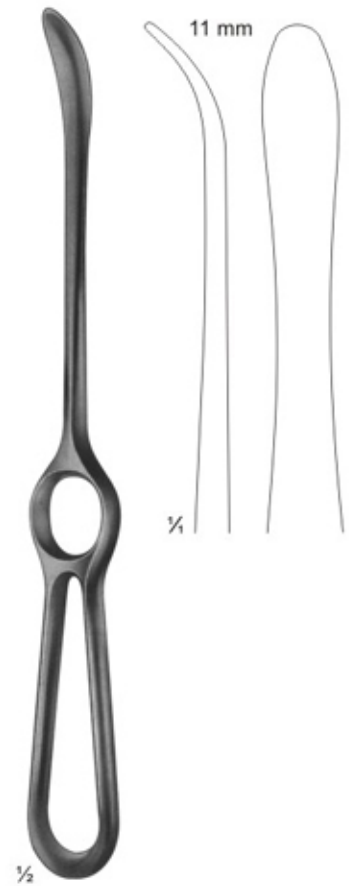

**16-108**  
LANGENBACK  
230mm



**Bone Levers**



1/2  
**16-109**  
LANE TRETHOWAN  
215mm

1/2  
**16-110**  
LANE  
255mm

1/2  
**16-111**  
LANGE-HOHMANN  
250mm

1/2  
**16-112 - 113**  
LANGE-HOHMANN modif.  
**16-112** 265mm  
**16-113** 280mm

# Raspatories



**16-114**  
PARTSCH  
150 mm

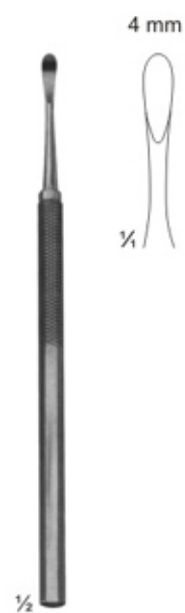

**16-116**  
PARTSCH mod. LANGE  
145 mm

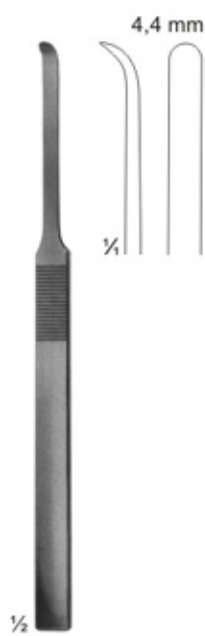

**16-117**  
MC KENTY  
155 mm

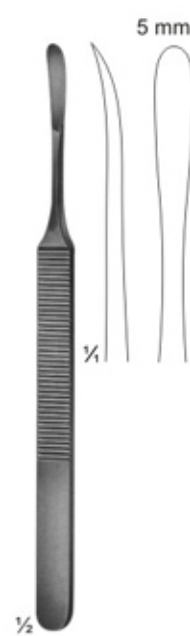

**16-118**  
KOENIG  
155 mm

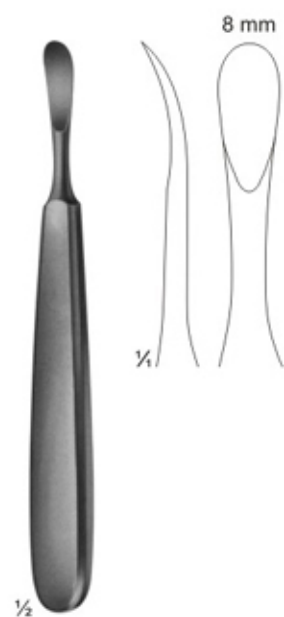

**16-119**  
TRELAT  
150 mm

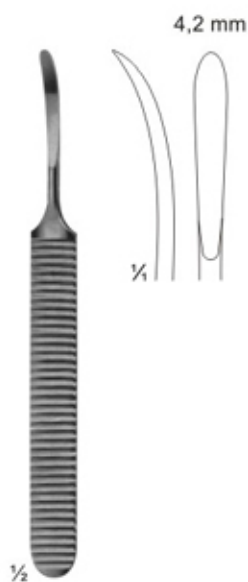

**16-120**  
WILLIGER  
140 mm



**16-121**  
WILLIGER  
160 mm

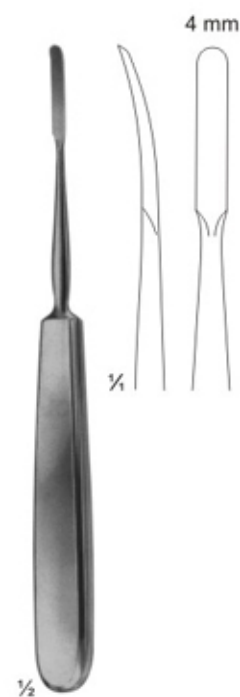

**16-122**  
JOSEPH  
170 mm



# Bone File and Rasps

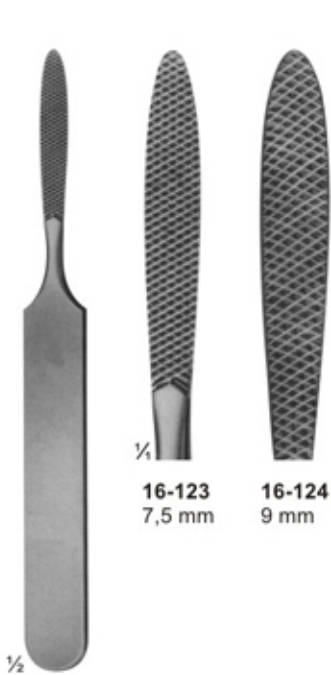

**16-123**  
JOSEPH  
fine, chequered

**16-124**  
coarse, chequered  
165 mm

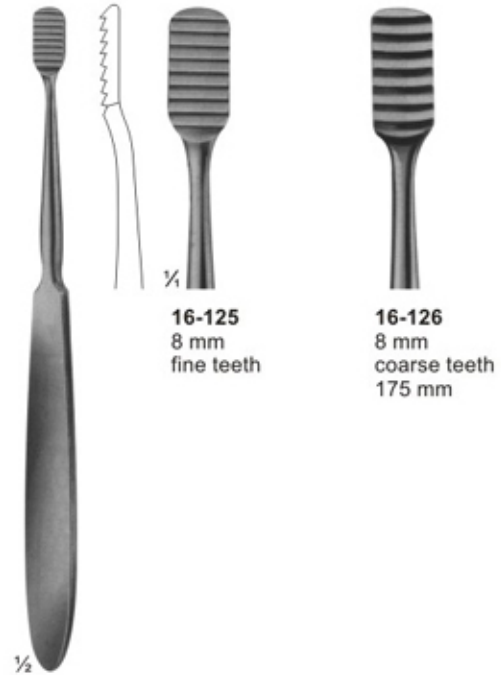

**16-125 - 16-126**  
LEWIS



**16-127**  
MALTZ  
down stroke  
180 mm

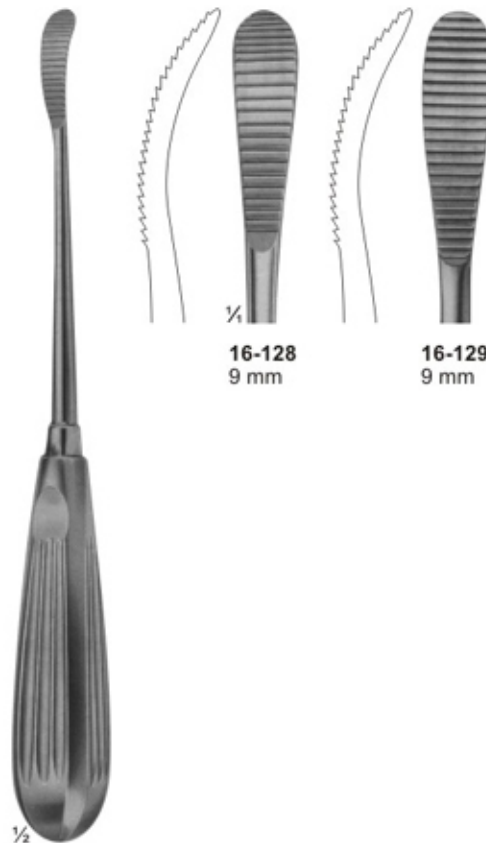

**16-128 - 16-129**  
AUFRICHT  
up stroke  
**16-129**  
down stroke  
220 mm



**16-130**  
GALLAHER  
190 mm

## Bone Currettes



**16-131**  
JACOBSON  
140 mm

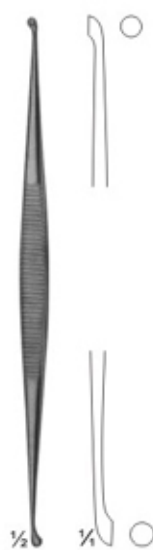

**16-132**  
MARTINI  
140 mm



**16-133**  
MARTINI  
140 mm



**16-134**  
WILLIGER  
145 mm



**16-135**  
JANSEN  
160 mm



**16-136**  
BARTH  
180 mm



**16-137**  
VOLKMANN  
130 mm

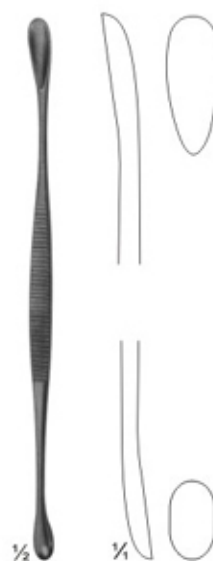

**16-138**  
VOLKMANN  
145 mm



**16-139**  
VOLKMANN  
170 mm

**Mallets** Weights refer to the heads of the mallets

**Hammer** Die Gewichtsangaben beziehen sich auf den Kopf des jeweiligen Hammers



∅ 20 mm

½

**17-101**  
MEAD  
185 g  
with interchangeable  
plastic disks  
190 mm  
**17-102**  
pair of spare disks



∅ 25 mm

½

**17-103**  
140 g  
with interchangeable  
plastic disks  
185 mm  
**17-104**  
pair of spare disks



∅ 30 mm

½

**17-105**  
COTTLE  
140 g  
1 Side Flat  
1 Side convex  
185 mm



∅ 22 mm

½

**17-106**  
165 g  
lead filled head  
190 mm



# Osteotomes, Chisels and Gouges



17-107  
MANNERFELT  
Gouge  
155 mm

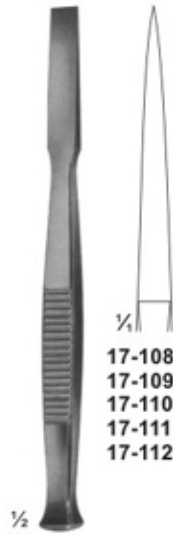

17-108 - 112  
Osteotomes  
140 mm

17-108 4 mm  
17-109 6 mm  
17-110 8 mm  
17-111 10 mm  
17-112 12 mm

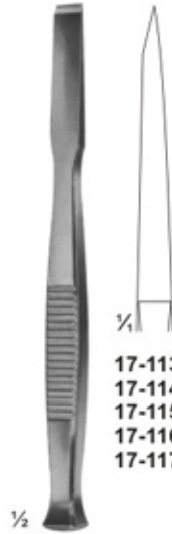

17-113 - 117  
Chisels  
140 mm

17-113 4 mm  
17-114 6 mm  
17-115 8 mm  
17-116 10 mm  
17-117 12 mm



17-118 - 122  
Gouges  
140 mm

17-118 4 mm  
17-119 6 mm  
17-120 8 mm  
17-121 10 mm  
17-122 12 mm

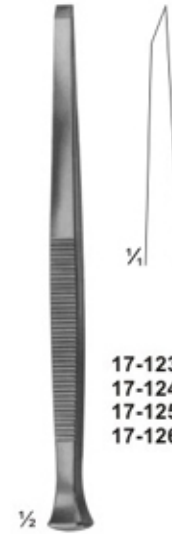

PARTSCH  
17-123 - 126  
Chisels  
140 mm

17-123 3 mm  
17-124 4 mm  
17-125 5 mm  
17-126 6 mm

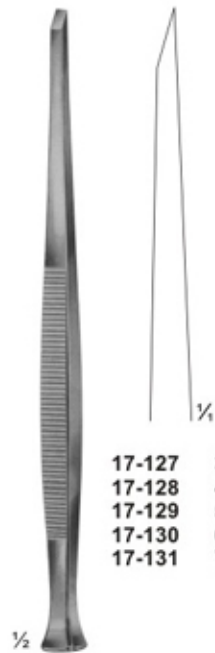

PARTSCH  
17-127 - 131  
Chisels  
170 mm

17-127 3 mm  
17-128 4 mm  
17-129 5 mm  
17-130 6 mm  
17-131 7 mm



PARTSCH  
17-132 - 135  
Gouges  
140 mm

17-132 3 mm  
17-133 4 mm  
17-134 5 mm  
17-135 6 mm



PARTSCH  
17-136 - 140  
Gouges  
170 mm

17-136 3 mm  
17-137 4 mm  
17-138 5 mm  
17-139 6 mm  
17-140 7 mm



LUCAS  
17-141 - 142  
Chisels  
160 mm

17-141 4 mm  
17-142 6 mm



LUCAS  
17-143 - 144  
Gouges  
160 mm

17-143 3 mm  
17-144 5 mm

## Reposition Forceps, Bone Holding Forceps



**17-145**  
Patella forceps  
185 mm



**17-146**  
Forceps with  
ratchet fixation  
140 mm



**17-147**  
Forceps with  
thread fixation  
170 mm



**17-148**  
Forceps with  
thread fixation  
235 mm

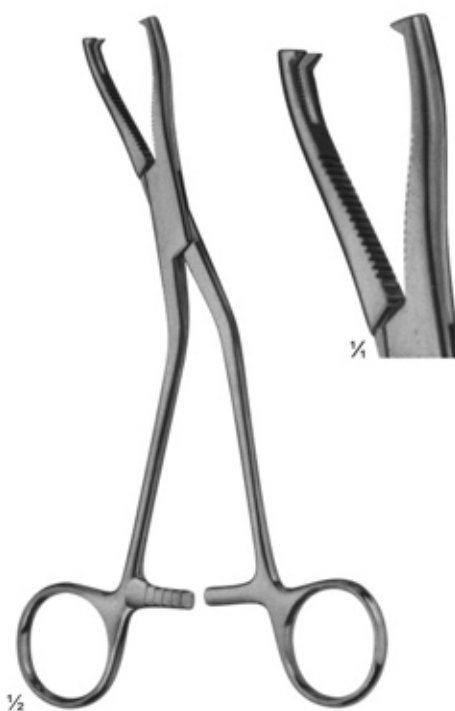

**17-149**  
DINGMANN  
185 mm

## Bone Holding Forceps & Bone Clamps



**Bone Rongeurs**



**17-158**  
LUER  
150 mm



**17-159**  
LUER  
155 mm



**17-160**  
BLUMENTHAL  
155 mm



**17-161**  
BLUMENTHAL  
150 mm



**17-162 - 163**  
JANSEN  
175 mm

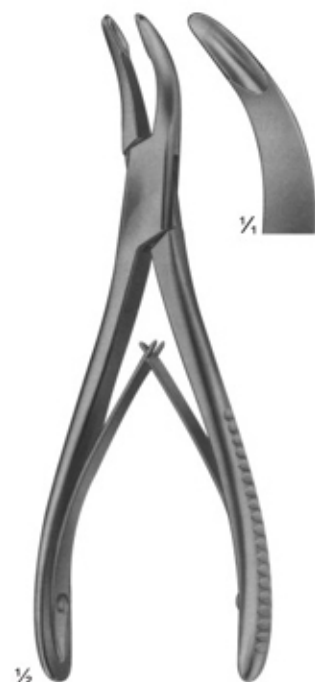

**17-164**  
BANE-HARTMANN  
175 mm

**Bone Rongeurs**





**Bone Cutting Forceps**

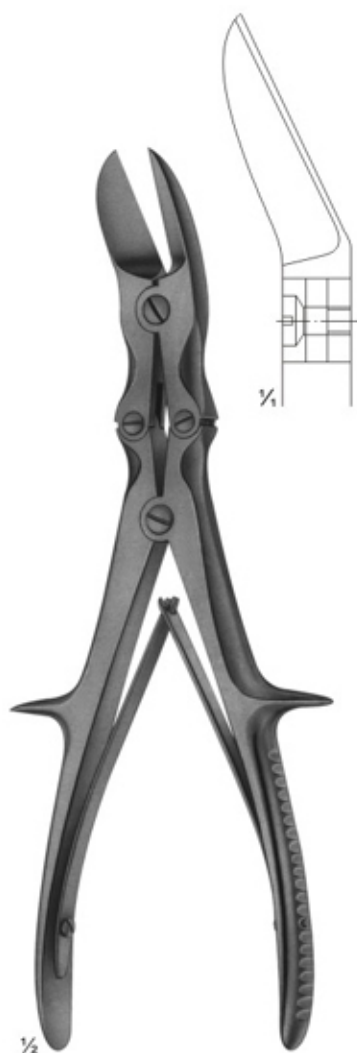

**17-168**  
LISTON  
curved on flat  
240 mm

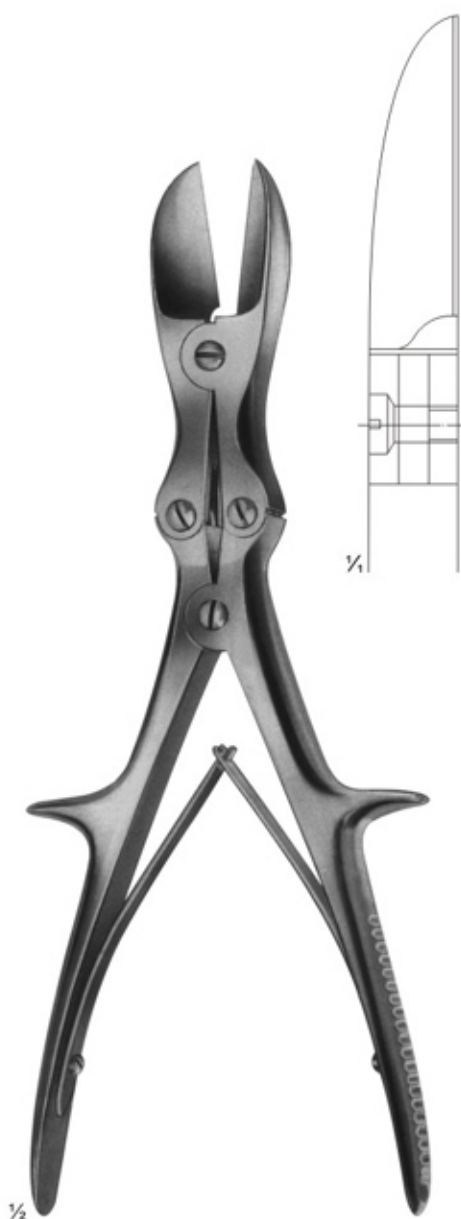

**17-169**  
LISTON  
straight  
280 mm

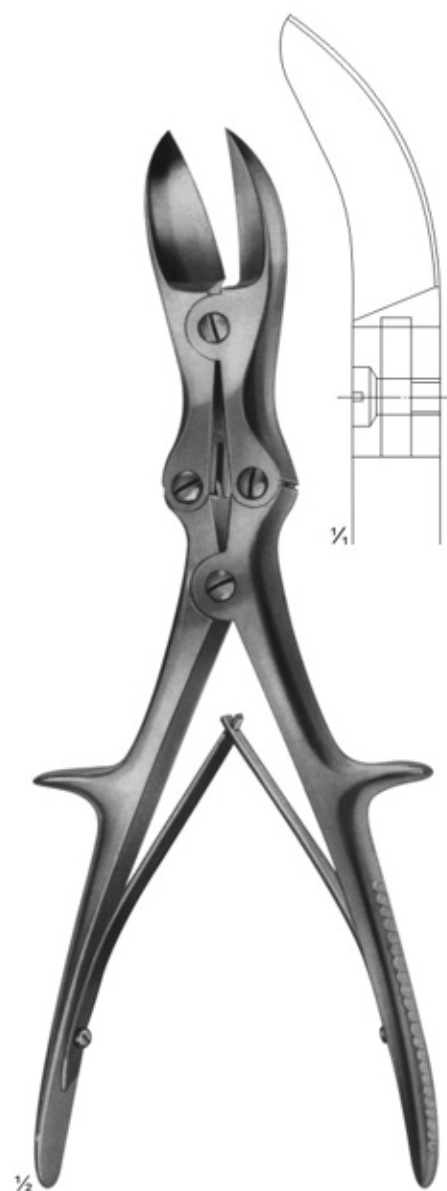

**17-170**  
LISTON  
curved on flat  
280 mm

# Wire Extension

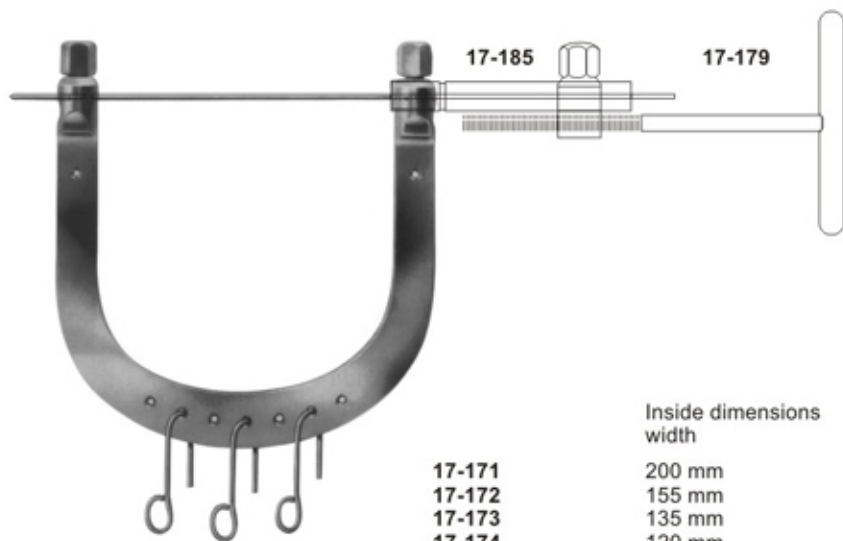

**17-171 - 17-177**  
**KIRSCHNER**  
 Wire traction bows,  
 to be used with  
**KIRSCHNER**-wires  
 up to 2.5 mm diam.,  
 With 3 hooks,  
 stainless steel

	Inside dimensions width	depth	
<b>17-171</b>	200 mm	155 mm	for the hip
<b>17-172</b>	155 mm	155 mm	for the femur
<b>17-173</b>	135 mm	130 mm	for the knee
<b>17-174</b>	120 mm	120 mm	for the knee
<b>17-175</b>	105 mm	100 mm	for the knee
<b>17-176</b>	95 mm	110 mm	for the calcaneus
<b>17-177</b>	95 mm	70 mm	for the arm and elbow



**17-178**  
 Wrench, double - ended,  
 for wire traction bows



**17-179**  
 Wire tightener, with  
 clamping jaws



<b>17-182</b>	max. 105 mm
<b>17-183</b>	max. 160 mm
<b>17-184</b>	max. 200 mm
<b>17-182</b>	80-95 mm
<b>17-183</b>	90-120 mm
<b>17-184</b>	140-170 mm
diam upto	
<b>17-182</b>	1,6 mm
<b>17-183</b>	2,0 mm
<b>17-184</b>	2,5 mm

**17-182 - 17-184**  
**KIRSCHNER**  
 Wire traction bows, modified,  
 adjustable in width, holds wire  
 securely, with 1 hook



**17-180**  
 Traction hook only,  
 large size



**17-181**  
 Traction hook only,  
 small size



**17-185**  
 Fixation clamp, to secure clamping  
 jaws of **17-179** stainless steel

**Cerclage Instruments**

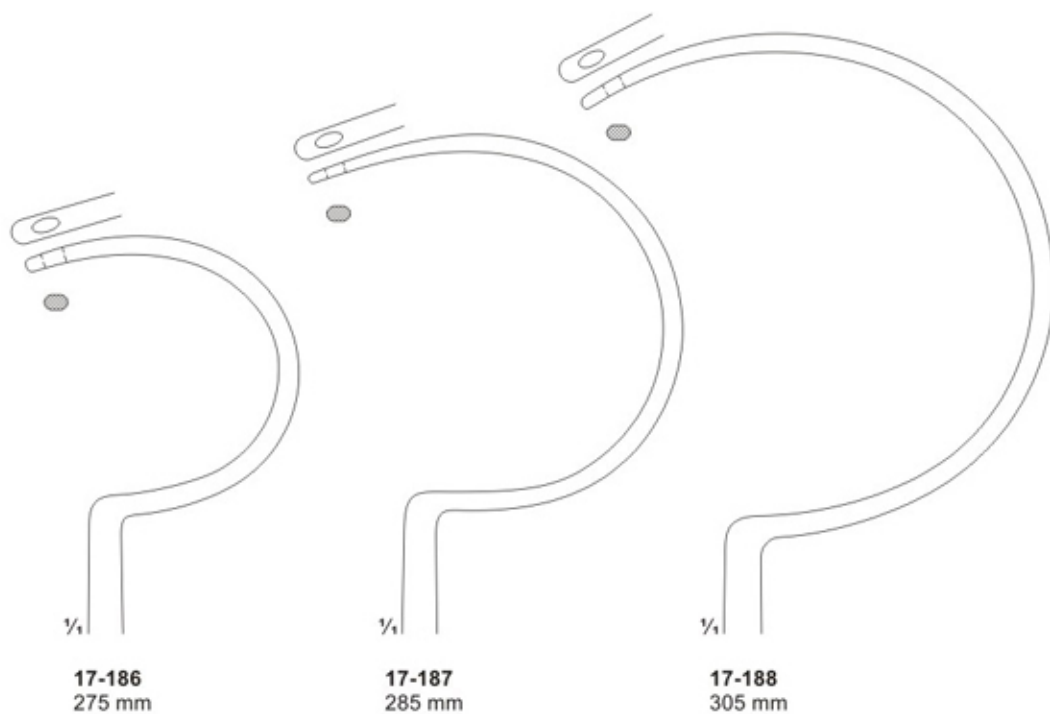

**17-186 - 17-188**  
DEMEL  
Wire guides

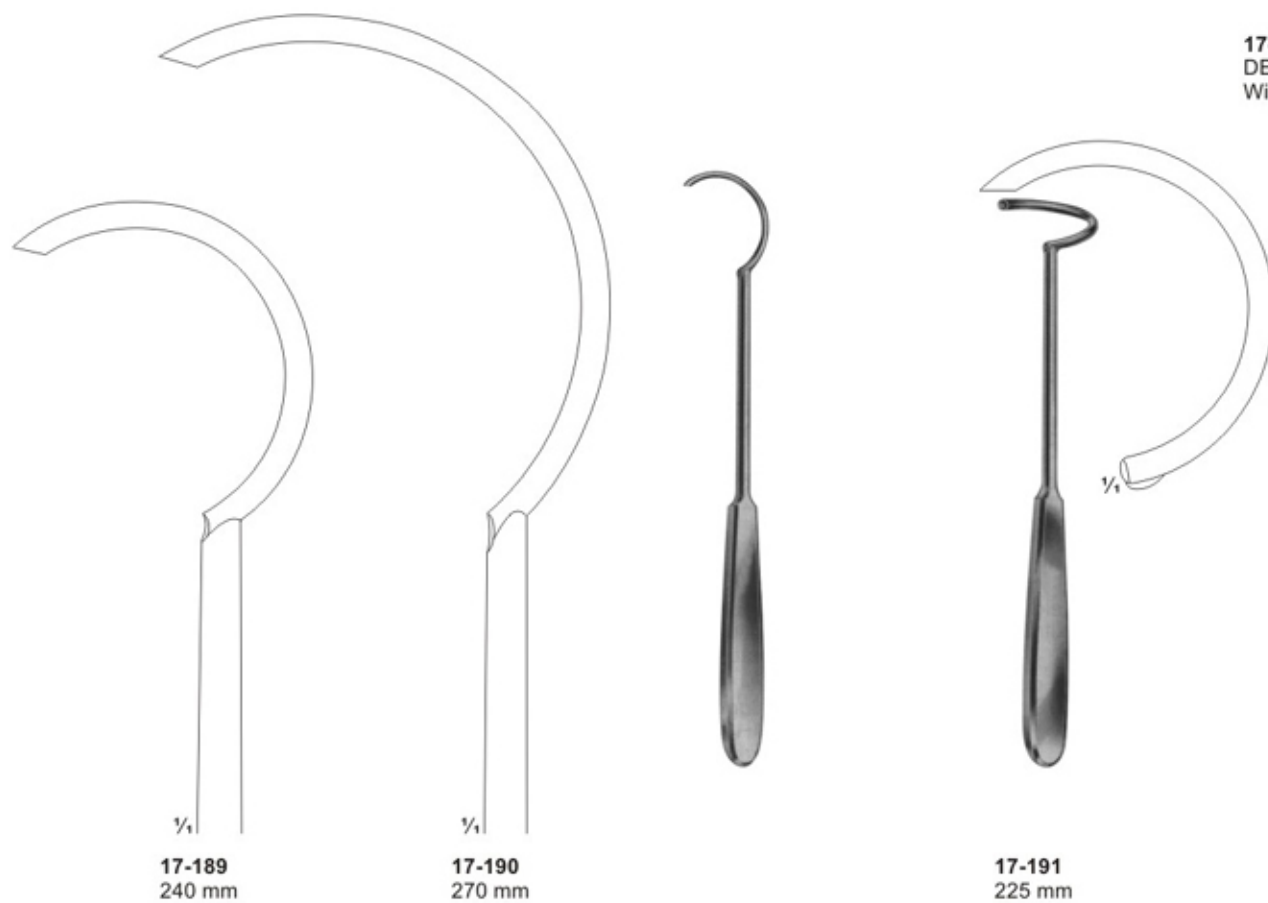

**Wire Holding forceps, Wire Tightening Pliers, Flat-nosed Pliers DUROGRIP with Hard Metal Inserts**



**17-192**  
DUROGRIP  
Holding forceps for cerclage wire, with lateral jaws to avoid wire slipping off  
170 mm



**17-193**  
DUROGRIP  
Wire, tightening pliers,  
Ligature pliers  
150 mm



**17-194**  
DUROGRIP  
Wire, tightening pliers,  
Ligature pliers  
150 mm

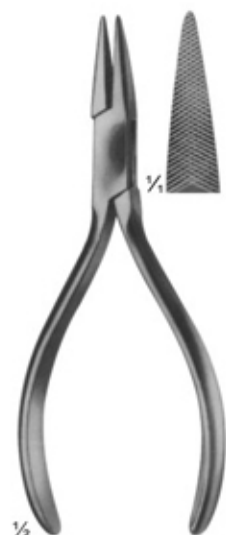

**17-195**  
with serrated jaws  
140 mm



**17-196**  
one jaw smooth,  
one jaw serrated  
140 mm



**17-197**  
with serrated jaws  
**17-198**  
with longitudinal and  
transversal grooves  
170 mm



**17-199**  
190 mm



# Wire Holding forceps, Flat-nosed Pliers, Pliers for bending and cutting wires



**17-200**  
130 mm

**17-201**  
180 mm

**17-200 - 17-201**  
Extraction pliers  
for boring wires



**17-202**  
Flat-nosed pliers,  
parallel  
185 mm

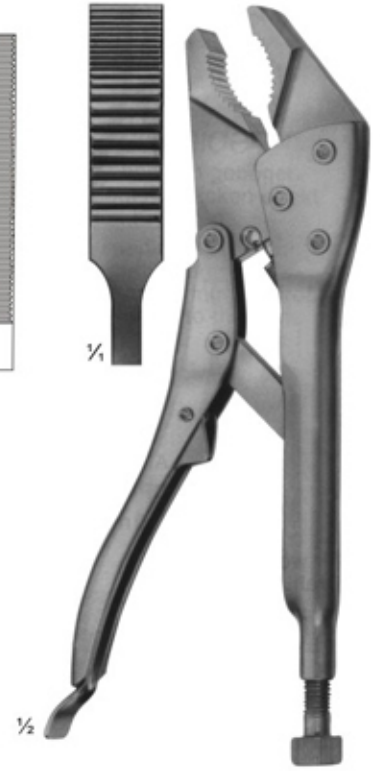

**17-203**  
Vise grip  
200 mm

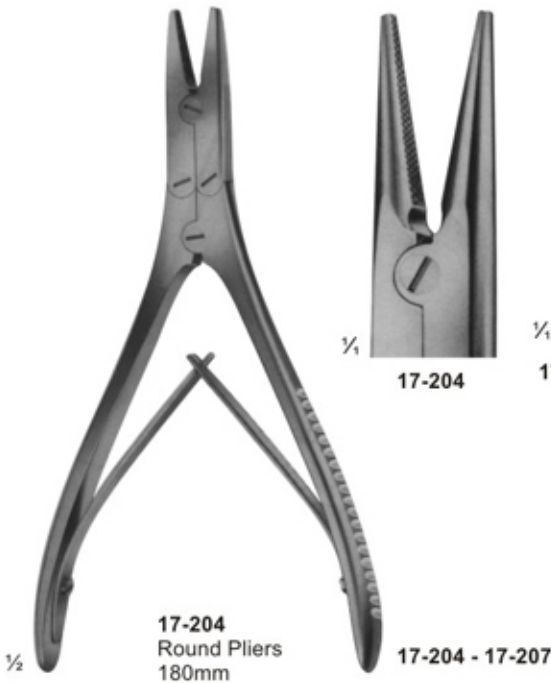

**17-204**  
Round Pliers  
180mm

**17-204 - 17-207**

**17-205** 145 mm  
**17-206** 180 mm  
**17-207** 180 mm  
Extraction pliers for wires



**17-208**  
Bending pliers  
for wires up to  
1.8 mm diam.



# Wire Cutters and wire Cutting Scissors DUROTIP with Carbide Cutting Edges



**17-209**  
ANGLE  
130 mm

for soft wire  
up to diam.  
for hard wire  
up to diam.

0,5 mm  
0,3 mm

**17-210**  
DUROTIP  
ANGLE  
130 mm

0,6 mm  
0,4 mm

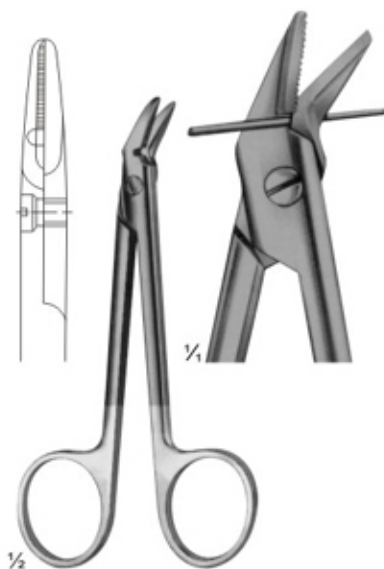

**17-211**  
120 mm

for soft wire  
up to diam.  
for hard wire  
up to diam.

1,2 mm  
0,8 mm

**17-212**  
DUROTIP  
120 mm

1,2 mm  
0,8 mm

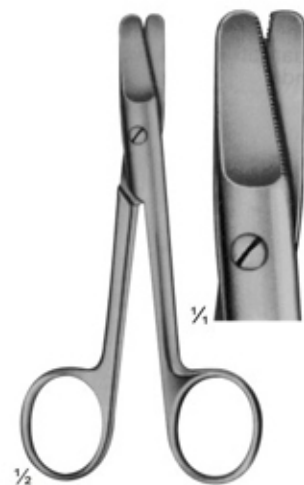

**17-213**  
HARVEY  
125 mm

0,4 mm  
0,3 mm

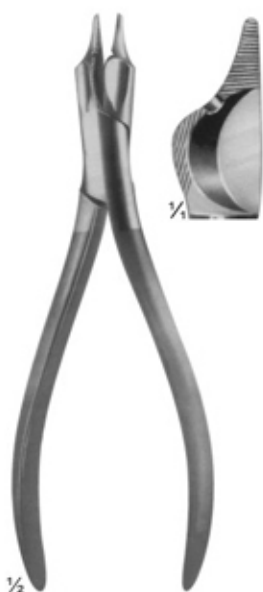

**17-214**  
150 mm

for soft wire  
up to diam  
for hard wire  
up to diam

1,5 mm  
1,0 mm



**17-215**  
160 mm

1,5 mm  
1,2 mm



**17-216**  
140 mm  
DUROTIP  
1,5 mm

1,0 mm

## Wire Cutting Pliers, Lateral Cutting Action

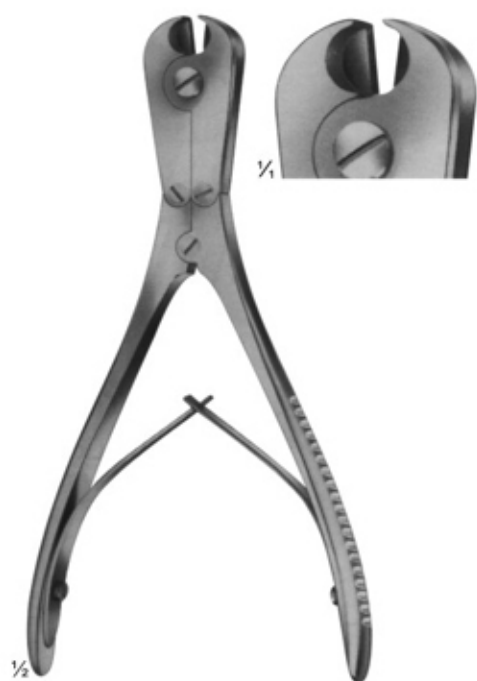

**17-217**  
180 mm

for soft wire  
up to diam. 2,0 mm  
For hard wire 1,5 mm  
up to diam  
specially hardened  
cutting edges, front  
and lateral cutting  
action



**17-218**  
REILL  
175 mm

for soft wire  
up to diam. 2,0 mm  
For hard wire 1,6 mm  
up to diam  
specially hardened  
cutting edges, for  
cutting off wires close  
to the bone



**DUROTIP**

**17-219**  
235 mm

for soft wire  
up to diam. 3,0 mm  
For hard wire 2,2 mm  
up to diam

# Wire Cutting Pliers, Lateral and Front Cutting Action



specially hardened cutting edges

**17-220**  
240 mm

for soft wire up to diam. 2,0 mm  
For hard wire up to diam 1,6 mm



Durotip

**17-221**  
145 mm

for soft wire up to diam. 1,5 mm  
For hard wire up to diam 1,0 mm



Durotip

**17-222**  
145 mm

for soft wire up to diam. 2,0 mm  
For hard wire up to diam 1,5 mm



Durotip

**17-223**  
220 mm

for soft wire up to diam. 3,5 mm  
For hard wire up to diam 2,5 mm

## Wire Cutting Pliers



**17-224**  
320 mm

for soft wire  
up to diam. 3,0 mm  
For hard wire  
up to diam. 3,0 mm



Cutter for cutting off  
KIRSCHNER wires,  
Tibia head screws,  
bolts, pins, up to 3 mm diam.



**DURROTIP**

**17-225**  
Cutter for cutting off  
KIRSCHNER wires,  
Tibia head screws,  
bolts, pins, up to 6 mm diam.  
470 mm

## Finger Nail Instruments

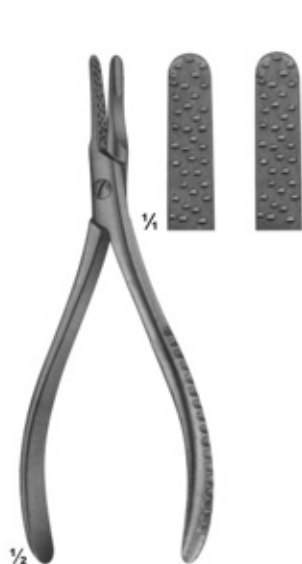

**17-226**  
Nail extracting  
forceps  
135 mm



**17-227**  
Nail extracting  
forceps  
145 mm

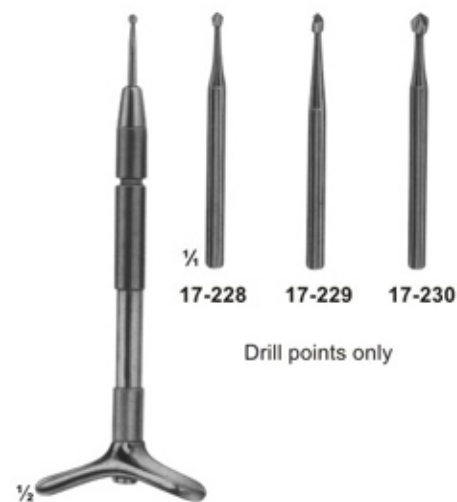

**17-228**  
Finger nail drill  
with 3 drill points

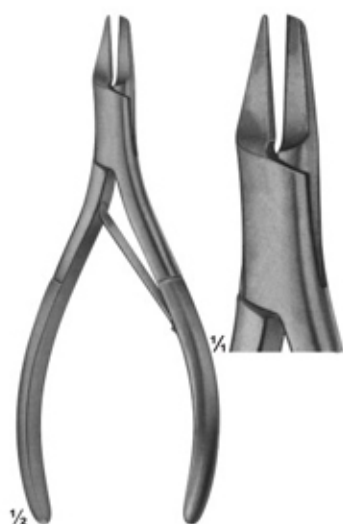

**17-231**  
Nail splitting  
forceps  
135 mm



**17-232**  
SYSTRUNK  
Scissors, for splitting  
finger nails  
130 mm



**17-233**  
Finger ring saw  
150 mm



# Plaster Shears



**17-235**  
STILLE-AESFULAP  
260 mm



**17-236**  
STILLE-AESFULAP  
360 mm

**Plaster Spreader, Plaster Breakers**



**17-237**  
HENING  
270 mm



**17-238**  
MOD. USA  
230 mm



**17-239**  
290 mm



with removable jaws



**17-240 - 17-241**  
WOLFF  
17-240 180 mm  
17-241 240 mm  
plaster breakers

## Vacuum Curettes for Aspiration Lipectomy, Suction Instruments

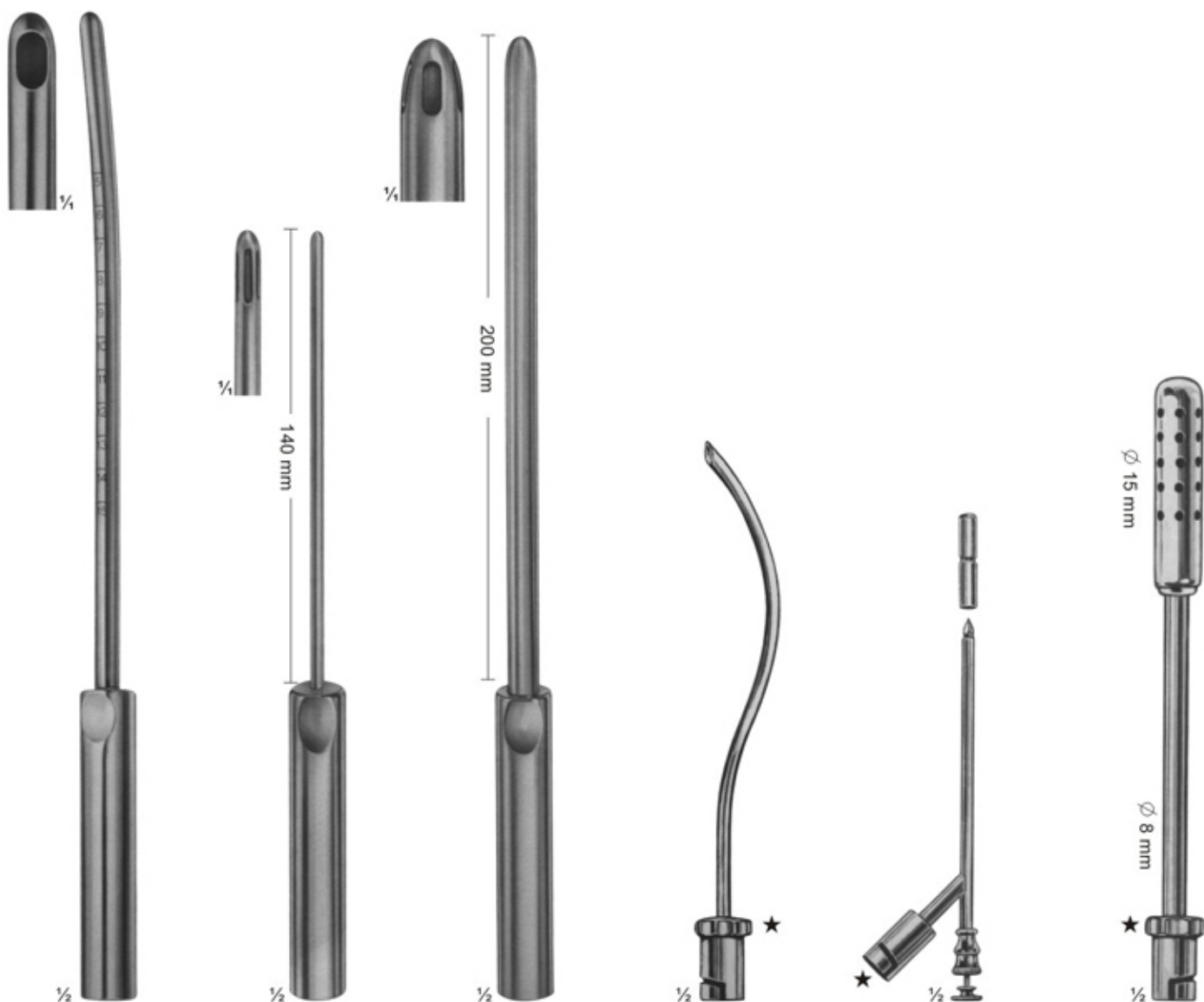

**18-101 - 18-106**

BIEMER

18-101  $\varnothing$  4 mm

18-102  $\varnothing$  6 mm

18-103  $\varnothing$  8 mm

18-104  $\varnothing$  10 mm

18-105  $\varnothing$  12 mm

18-106  $\varnothing$  14 mm

Curettes for aspiration lipectomy, graduated, slightly curved

**18-107 - 18-108**

BIEMER

18-107  $\varnothing$  4 mm

18-108  $\varnothing$  6 mm

Curettes for aspiration lipectomy, with three apertures, slightly curved malleable

**18-109 - 18-111**

BIEMER

18-109  $\varnothing$  8 mm

18-110  $\varnothing$  10 mm

18-111  $\varnothing$  12 mm

Curettes for aspiration lipectomy, with three apertures, slightly curved malleable

**18-112**

For aspirating fluid from the excretory ducts of large glands and for keeping the operating area clear 170 mm

**18-113**

Trocar

For puncturing 150 mm

**18-114**

For clearing large quantities of fluid 190 mm

## Suction Instruments

**18-115** 150mm  
Suction handle, with vacuum regulator and finger cut-off, brass, mirror-finish chromium-plated



olive  
Ø9 mm

**18-116** 170mm  
Suction handle, with hand regulation valve and quick-shutter, brass, mirror-finish chromium-plated



Both suction handles have bayonet fitting Olive and can be used for the suction cannulae. Ø9 mm



**18-117**  
Trocar  
For puncturing  
170 mm



**18-118**  
Hollow needle,  
sharp  
150 mm



**18-119**  
double curved  
For general  
surgery  
230 mm



**18-120**  
For tonsillectomy,  
oral and laryngeal  
operations  
190 mm



**18-121**  
For tonsillectomy,  
oral and laryngeal  
operations  
220 mm

★ With bayonet fitting to be used with suction handles (18-115 - 18-116)



# Suction Instruments

**18-122**  
WULLSTEIN  
Suction tube, conical, silver, olive  
with LUER hub  
160 mm



**18-123** 1,5 mm  
**18-124** 2,0 mm  
WULLSTEIN  
Suction tube, cylindrical, silver, with  
stylet olive with LUER hub  
160 mm



Usable length

YASARGIL usable length diam.		YASARGIL usable length diam.	
<b>18-125</b>	130 mm 1,5 mm	<b>18-133</b>	130 mm 2,5 mm
<b>18-126</b>	150 mm 1,5 mm	<b>18-134</b>	150 mm 2,5 mm
<b>18-127</b>	180 mm 1,5 mm	<b>18-135</b>	180 mm 2,5 mm
<b>18-128</b>	220 mm 1,5 mm	<b>18-136</b>	220 mm 2,5 mm
<b>18-129</b>	130 mm 2,0 mm	<b>18-137</b>	130 mm 3,5 mm
<b>18-130</b>	150 mm 2,0 mm	<b>18-138</b>	150 mm 3,5 mm
<b>18-131</b>	180 mm 2,0 mm	<b>18-139</b>	180 mm 3,5 mm
<b>18-132</b>	220 mm 2,0 mm	<b>18-140</b>	220 mm 3,5 mm
		<b>18-141</b>	180 mm 4,5 mm

olive  
Ø 6,5-9 mm  
with LUER hub

**18-142 - 18-144**  
LANDOLT  
150 MM  
diam Ø 3 mm

**18-142** 8 mm / curved  
**18-143** 11mm / curved  
**18-144** 15mm / curved

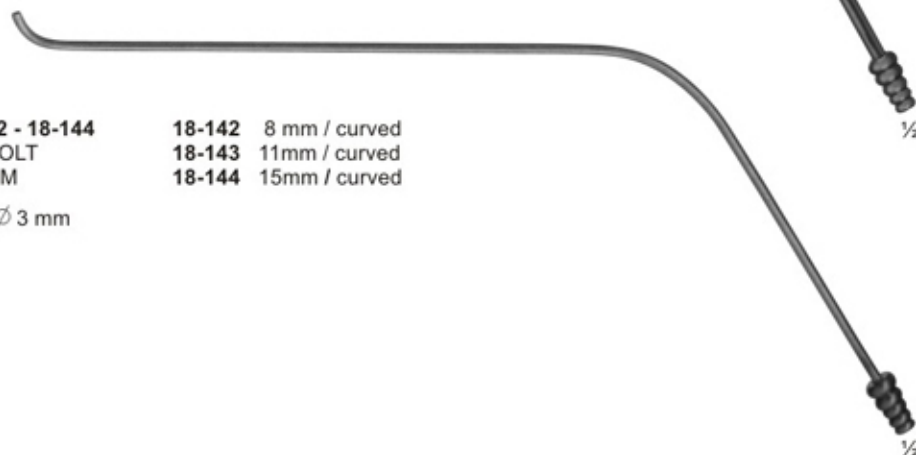

**18-145** 500 mm  
**18-146** 350 mm  
with rubber tip,  
with LUER hub

olive Ø 9 mm

**18-147** 2,0 mm diam  
**18-148** 2,5 mm diam  
**18-149** 3,0 mm diam  
with finger cut-off,  
thumb piece 90° to  
curve, with LUER hub  
250 mm

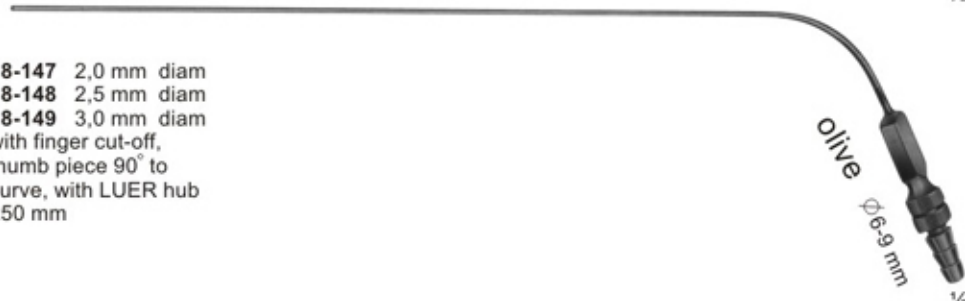

olive Ø 6-9 mm





# Combined Suction and Irrigation Cannulae, Coagulation Suction Cannulae

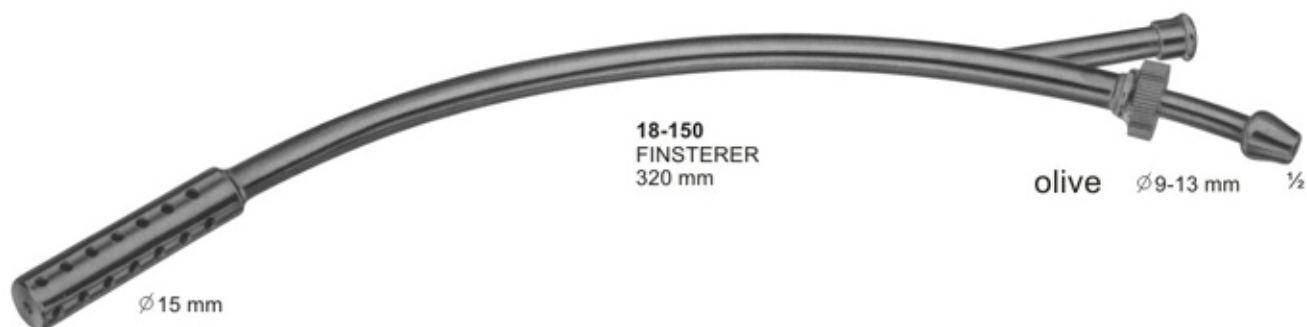

**18-150**  
FINSTERER  
320 mm

olive  $\varnothing$ 9-13 mm 1/2

$\varnothing$  15 mm



**18-151**  
YASARGIL  
LUER-LOCK cone  
200 mm

$\varnothing$  2 mm

$\varnothing$  4,5 mm

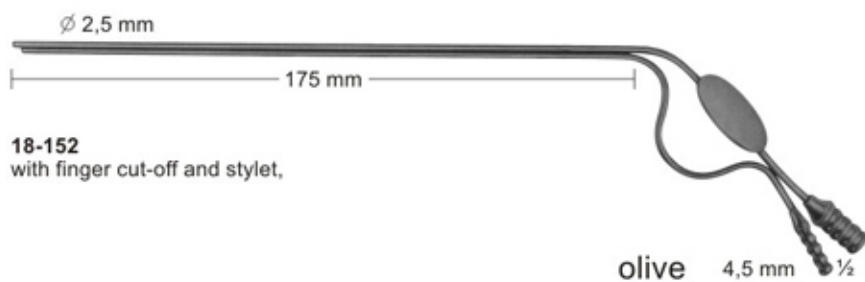

**18-152**  
with finger cut-off and stylet,

$\varnothing$  2,5 mm

175 mm

olive 4,5 mm 1/2

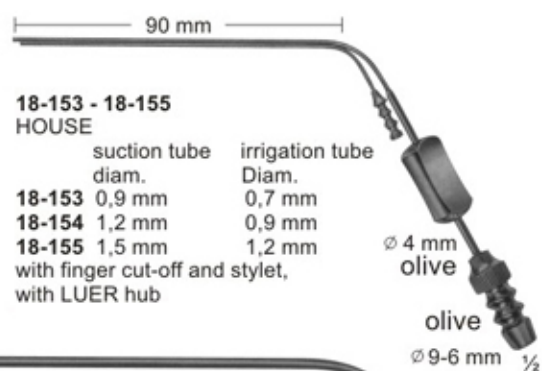

**18-153 - 18-155**  
HOUSE

	suction tube diam.	irrigation tube Diam.
<b>18-153</b>	0,9 mm	0,7 mm
<b>18-154</b>	1,2 mm	0,9 mm
<b>18-155</b>	1,5 mm	1,2 mm

with finger cut-off and stylet,  
with LUER hub

90 mm

$\varnothing$  4 mm  
olive

olive  
 $\varnothing$ 9-6 mm 1/2

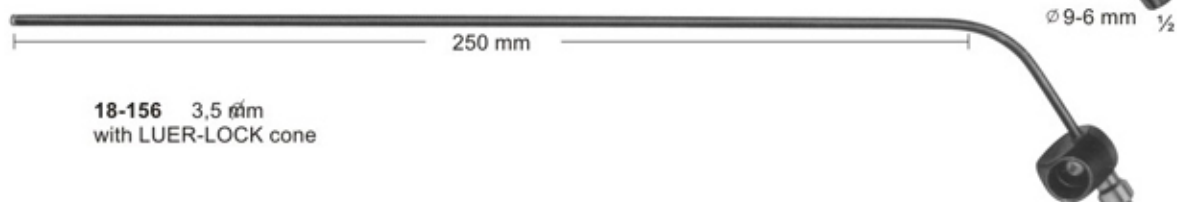

**18-156** 3,5 mm  
with LUER-LOCK cone

250 mm

olive  $\varnothing$  9 mm 1/2



**18-157**  $\varnothing$  5.0 mm  
LANDOLT  
with finger cut-off and  
stylet, can be sterilized  
in an autoclave up to 3 bar (143 °C)

Connection for  
suction hose

$\varnothing$  7,5-12 mm  
olive

4 mm diam., Untarnished  
contact to be touched by  
HF-electrodes

# Suction Instruments

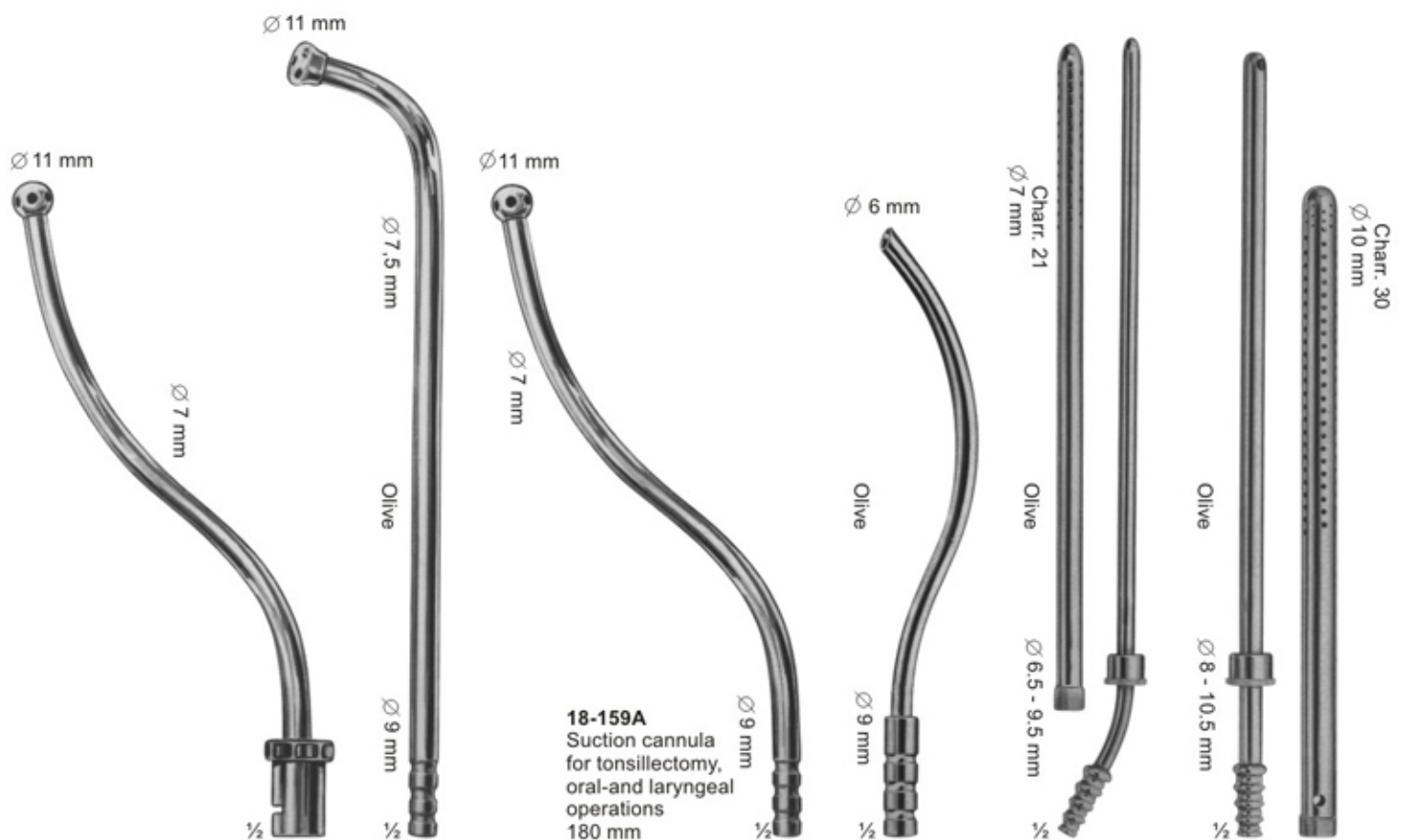

**18-158**  
For tonsillectomy,  
oral-and laryngeal  
operations  
180 mm

**18-159**  
Suction cannula  
for tonsillectomy,  
oral-and laryngeal  
operations  
220 mm

**18-159A**  
Suction cannula  
for tonsillectomy,  
oral-and laryngeal  
operations  
180 mm

**18-160**  
S-shaped blunt cannula  
for aspirating fluid from  
the excretory ducts of  
large glands and for  
keeping the operating  
area clear  
170 mm

**18-161**  
POOL  
Suction cannula,  
with outer tube  
to be screwed off  
225 mm

**18-162**  
POOL  
Suction cannula,  
with outer tube  
to be screwed off  
225 mm

# Suction Instruments

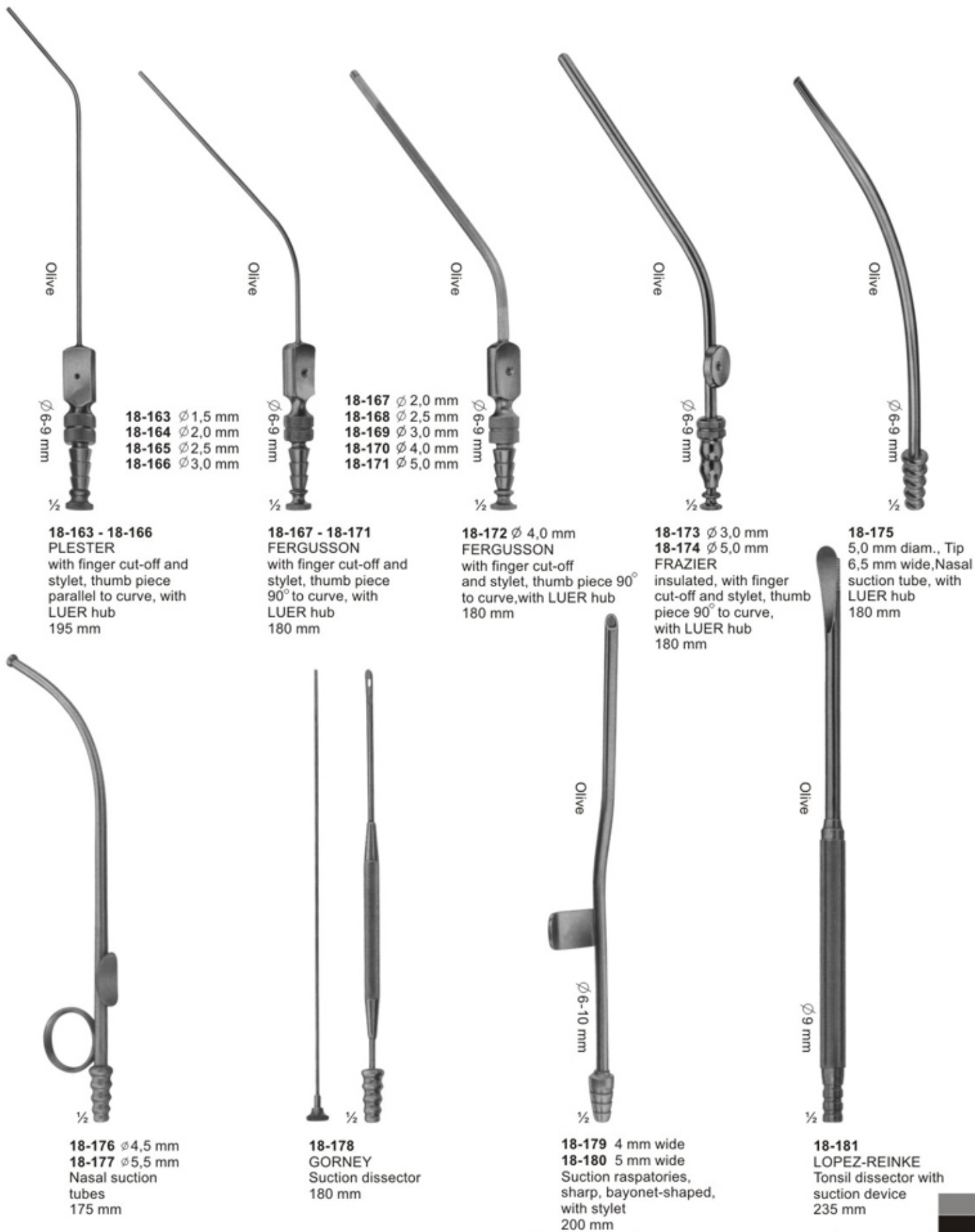

Olive

Ø 6-9 mm

- 18-163 Ø 1,5 mm
- 18-164 Ø 2,0 mm
- 18-165 Ø 2,5 mm
- 18-166 Ø 3,0 mm

1/2

**18-163 - 18-166**  
**PLESTER**  
 with finger cut-off and  
 stylet, thumb piece  
 parallel to curve, with  
 LUER hub  
 195 mm

Olive

Ø 6-9 mm

- 18-167 Ø 2,0 mm
- 18-168 Ø 2,5 mm
- 18-169 Ø 3,0 mm
- 18-170 Ø 4,0 mm
- 18-171 Ø 5,0 mm

1/2

**18-167 - 18-171**  
**FERGUSSON**  
 with finger cut-off and  
 stylet, thumb piece  
 90° to curve, with  
 LUER hub  
 180 mm

Olive

Ø 6-9 mm

**18-172** Ø 4,0 mm  
**FERGUSSON**  
 with finger cut-off  
 and stylet, thumb piece 90°  
 to curve, with LUER hub  
 180 mm

Olive

Ø 6-9 mm

**18-173** Ø 3,0 mm  
**18-174** Ø 5,0 mm  
**FRAZIER**  
 insulated, with finger  
 cut-off and stylet, thumb  
 piece 90° to curve,  
 with LUER hub  
 180 mm

Olive

Ø 6-9 mm

**18-175**  
 5,0 mm diam., Tip  
 6,5 mm wide, Nasal  
 suction tube, with  
 LUER hub  
 180 mm



1/2

**18-176** Ø 4,5 mm  
**18-177** Ø 5,5 mm  
**Nasal suction**  
**tubes**  
 175 mm



1/2

**18-178**  
**GORNEY**  
**Suction dissector**  
 180 mm



Olive

Ø 6-10 mm

1/2

**18-179** 4 mm wide  
**18-180** 5 mm wide  
**Suction raspatories,**  
 sharp, bayonet-shaped,  
 with stylet  
 200 mm

Olive

Ø 9 mm

1/2

**18-181**  
**LOPEZ-REINKE**  
**Tonsil dissector with**  
**suction device**  
 235 mm

## Dissection Instruments

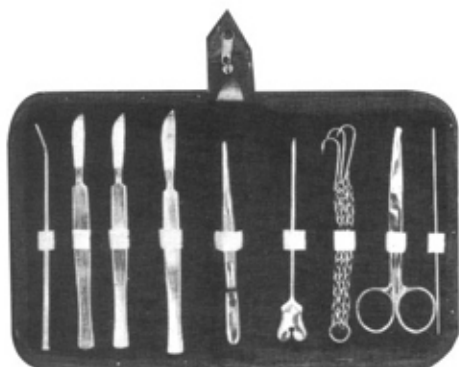

### 18-182

- 1- Blow pipe .
- 2- 3 PCS .scalpel.
- 3- Dissecting forcep 13 cm.
- 4- Grooved director with tounge tie 13 cm.
- 5- Triple chain hook.
- 6- Dressing scissors probe pointed 13 cm.
- 7- Probe double 13 cm.
- 8- Zipper case inside red velvet.

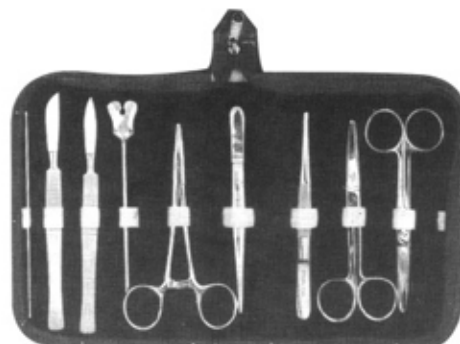

### 18-183

- 1- Probe Double 13 cm
- 2- 2 PCS. Scalpel S.S
- 3- Grooved Director With tongue Tie 13 cm
- 4- Mayo Hegar Needle Holder 13cm
- 5- Discting Forcep 13 cm 1x2 Teeth
- 6- Dressing Forcep 13 CMS Serrated.
- 7- Dressing Scissor 13 cm S/B STR.
- 8- Dressing Scissor 13 cm S/B CVD.
- 9- Zipper Case Inside Red Velvet.

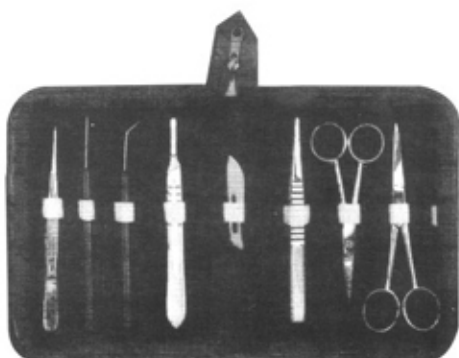

### 18-184

- 1- Dissecting Forcep 11.5 cm Sharp Point.
- 2- Iris Scissor
- 3- B.P Handle No. 4
- 4- Teasing Needle Sharp angular.
- 5- Blade No. 22
- 6- Thumb Forceps T.O.E 13 cm
- 7- Dissecting Scissor STR 11.5 cm
- 8- Dissecting Scissor STR 13 cm
- 9- Zipper case Inside Red Velvet

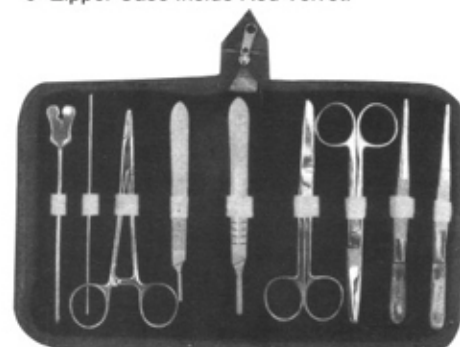

### 18-185

- 1- Grooved Director with Tongue Tie 14 cm
- 2- Probe Double 14cm
- 3- Mayo Hegar Needle Holder 14 cm
- 4- BP. Handle no.3
- 5- BP. Handle no.4
- 6- Dressing Scissor 14 cm S/B STR
- 7- Dressing Scissor 14 cm S/B CVD.
- 8- Dressing Forcep 1x2 Teeth 14 cm
- 9- Dressing Forcep Serrated 14 cm

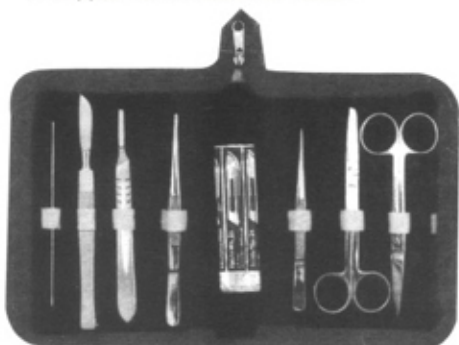

### 18-186

- 1- Probe double 12.5 cm
- 2- Scalpel
- 3- B.P Handle No. 4
- 4- 6 PCS Blade 2 each no. 21, 22, 23
- 5- Dissecting Forcep 12.5 cm
- 6- Dissecting Forcep 11.5 cm sharp Point
- 7- Dissecting Scissor S/B STR 13 cm
- 8- Dissecting Scissor S/S STR 13 cm

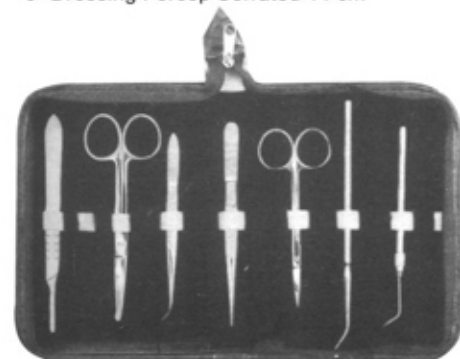

### 18-187

- 1- Teasing Needle with Chuck CVD.
- 2- Huber Probe
- 3- Iris Scissor
- 4- Dissecting Forcep Fine 14 cm.
- 5- Dissecting Forcep Fine CVD. 12 cm
- 6- Operating Scissor with Probe 14 cm.
- 7- B.P. Handle no. 4





**Benodict**  
SURGICAL INSTRUMENTS

## Dissection Instruments



### 18-188

- 1- Probe with eye
- 2- Dissecting Forcep cvd fine 12 cm.
- 3- Iris Scissor
- 4- Operating Scissor S/B str 14 cm
- 5- Grooved Director and Tongue tie
- 6- Huber Probe
- 7- Triple Chain Hook
- 8- B.P Handle No. 4
- 9- B.P Handle No. 3
- 10- Teasing Needle with Chuck cvd.
- 11- Teasing Needle with Chuck str.
- 12- Dissecting Forceps Fine 14 cm.

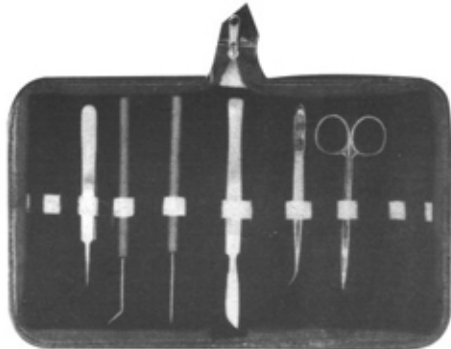

### 18-190

- 1- Iris Scissor STR
- 2- Dissecting Forceps CVD 12 cm.
- 3- Scapel
- 4- Teasing Needle STR wooden handle.
- 5- Teasing Needle CVD wooden handle.
- 6- Watchmaker fine point.

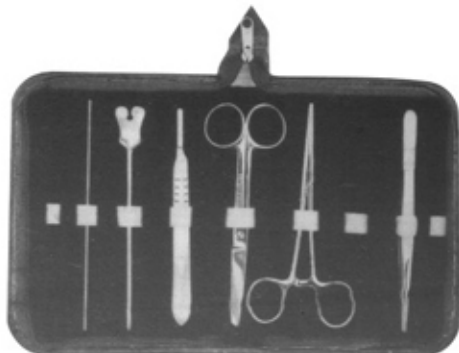

### 18-192

- 1- Probe double end.
- 2- Grooved director and tounge tie.
- 3- B.P handle no.4
- 4- Operating scissor STR S/b14cm.
- 5- Kelly forceps STR 14cm.
- 6- Dissecting forceps thumb 13cm.

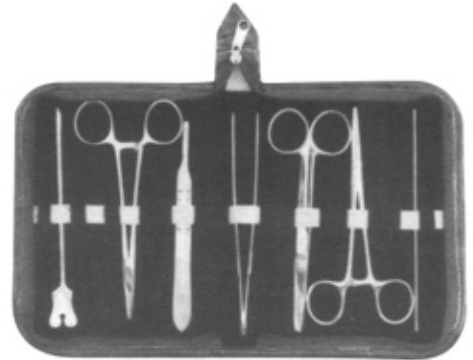

### 18-189

- 1- Grooved Director and Tongue tie
- 2- Mayo Hearg Needle Holder 14 cm
- 3- B.P Handle No. 4
- 4- Dissecting Forceps Thump 14 cm.
- 5- Operating Scissor S/B str 14 cm
- 6- Kelly Forcep STR 14 cm.
- 7- Probe Double end

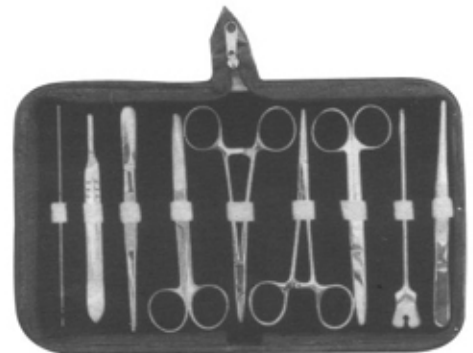

### 18-191

- 1- Probe Double end
- 2- B.P Handle No. 4
- 3- Dissecting Forcep 1x2 Teeth 14 cm.
- 4- Operating Scissor S/B str 14 cm
- 5- Mayo Hearg Needle Holder 14 cm
- 6- Kelly Forcep STR 14 cm.
- 7- Operating Scissor S/B CVD 14 cm
- 8- Grooved Director and Tongue tie
- 9- Dissecting Forceps Thumb 14 cm.

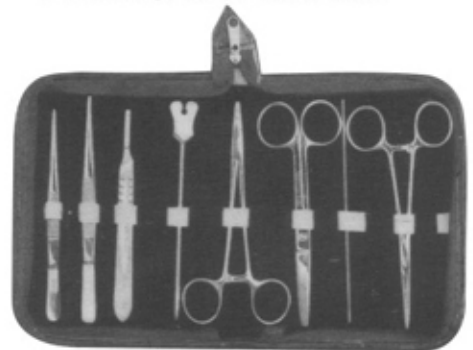

### 18-193

- 1- Dissecting Forceps Thumb 14 cm
- 2- Dissecting Forcep 1x2 Teeth 14 cm.
- 3- B.P Handle No. 3
- 4- Grooved Director and Tongue tie
- 5- Mayo Hearg Needle Holder 14 cm
- 6- Operating Scissor S/B str 14 cm
- 7- Probe Double end
- 8- Kelly Forcep STR 14 cm.



## Dissection Instruments

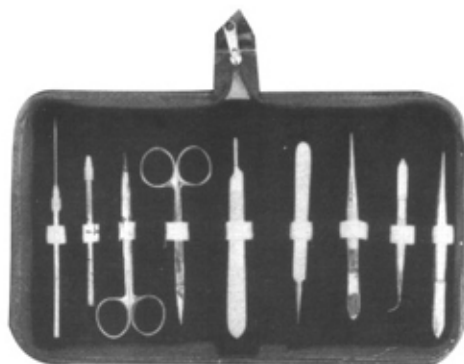

### 18-194

- 1- Dissecting Forcep Fine 14cm.
- 2- Dissecting Forcep Fine CVD 12cm
- 3- Dissecting Forcep with Pin 14cm.
- 4- Watchmaker Fine point
- 5- Iris scissor STR
- 6- Iris scissor CVD.
- 7- Teasing Needle holder
- 8- Teasing Needle STR.
- 9- B.P. Handle no. 3



### 18-195

- 1- Teasing Needle STR.
- 2- Grooved Director and Tongue Tie.
- 3- Teasing Needle CVD.
- 4- Dissecting Forcep with Pin 12 cm Fine
- 5- Operating Scissor S/B STR 14 cm
- 6- Triple Chain Hook
- 7- Probe with eye
- 8- Probe Double end
- 9- Probe and Hook
- 10- Dissecting Forcep Fine 14 cm
- 11- Iris Scissor
- 12- Huber Probe
- 13- B.P. Handle no.3
- 14- B.P. Handle no.4



### 18-196

- 1- Dissecting forcep fine STR with pin 12cm.
- 2- Iris scissor STR.
- 3- Probe with eye.
- 4- Probe and hook.
- 5- Operating scissor S/B STR 14cm
- 6- Triple chain hook.
- 7- B.P. handle no.4
- 8- Humber probe.
- 9- B.P.handle no.3
- 10- Teasing needle STR plastic handle.
- 11- Teasing needle CVD plastic handle.
- 12- Grooved director and tongue tie.
- 13- Probe double end.



### 18-197

- 1- Dissecting Forceps Thumb 14 cm.
- 2- Dissecting Forcep 1x2 Teeth 14 cm.
- 3- B.P Handle No. 3
- 4- Grooved Director and Tongue tie
- 5- Mayo Hearn Needle Holder 14 cm
- 6- Operating Scissor S/B str 14 cm
- 7- Probe Double end
- 7- Kelly Forcep STR 14 cm.

## Hospital Wares



**19-101 - 115**  
Schimmelbusch

	Ø x H sizes in mm
<b>19-101</b>	80 x 80
<b>19-102</b>	105 x 120
<b>19-103</b>	140 x 140
<b>19-104</b>	160 x 120
<b>19-105</b>	160 x 150
<b>19-106</b>	190 x 150
<b>19-107</b>	190 x 190
<b>19-108</b>	240 x 160
<b>19-109</b>	240 x 240
<b>19-110</b>	290 x 160
<b>19-111</b>	290 x 240
<b>19-112</b>	340 x 160
<b>19-113</b>	340 x 340
<b>19-114</b>	390 x 190
<b>19-115</b>	390 x 290



**19-116**  
Box  
120 x 65 x 13mm  
(without Bulldog clamps,  
without silicone tape)



**19-117**  
Box with support  
120 x 65 x 13 mm  
(ohne Bulldogklemmen)



**19-118**  
Box with support for  
needle electrodes,  
without instruments

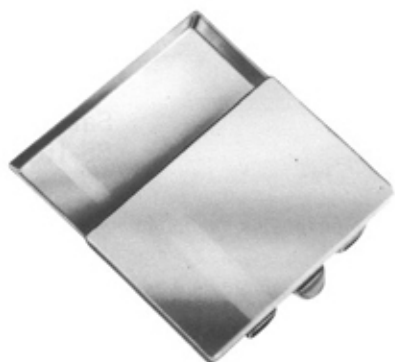

**19-119 - 121**  
50 x 25 x 4,5 mm  
**19-120**  
65 x 42 x 8 mm  
**19-121**  
75 x 25 x 4,5 mm



**19-122**  
Ø 65mm x 15mm



19-123 - 131

	Ø x H
19-123	30 x 90 mm
19-124	50 x 100 mm
19-125	50 x 130 mm
19-126	50 x 175 mm
19-127	75 x 100 mm
19-128	75 x 130 mm
19-129	75 x 175 mm
19-130	100 x 175 mm
19-131	100 x 200 mm



19-141 - 142

- 19-141 Martin Sterilizing Forceps consisting of:  
1 Sterilizing Forceps, curved, 25 cm, without ratchet, with lid for jar  
1 jar with bottom plate (anti-tilt)
- 19-142 ditto, with 32 cm long Sterilizing Forceps



19-132 - 139

19-132	165 x 85 x 35 mm
19-133	200 x 100 x 35 mm
19-134	200 x 100 x 50 mm
19-135	230 x 130 x 50 mm
19-136	260 x 150 x 50 mm
19-137	270 x 235 x 50 mm
19-138	300 x 200 x 50 mm
19-139	325 x 275 x 50 mm



19-140  
205 x 105 x 35 mm

## Round Metal Boxes and Medicine Cups



19-143 - 148

	Ø x H
19-143	75 x 60 mm
19-144	75 x 75 mm
19-145	100 x 60 mm
19-146	100 x 100 mm
19-146A	125 x 80 mm
19-147	125 x 125 mm
19-148	150 x 150 mm



19-149  
25 cc

19-150  
50 cc



19-151  
20 cc  
Medicine Spoon



19-152  
Ø 75 x 12 mm  
Tablet Tray



19-153  
Ø 90 x 90 mm  
Metal Cup



19-154  
Ø 75 x 80 mm  
Sputum Cup



Kidney Dish



19-155 - 157

19-155	170 x 100 x 35 mm
19-156	250 x 140 x 40 mm
19-157	275 x 150 x 45 mm



## Hospital Wares



**19-158 - 165**



**19-166 - 170**

	Ø x H	
<b>19-158</b>	40 x 19 mm	0.05L
<b>19-159</b>	61 x 30 mm	0.07L
<b>19-160</b>	80 x 40 mm	0.14L
<b>19-161</b>	116 x 50 mm	0.35L
<b>19-162</b>	128 x 55 mm	0.45L
<b>19-163</b>	147 x 65 mm	0.70L
<b>19-164</b>	167 x 75 mm	1.10L
<b>19-165</b>	187 x 85 mm	1.60L

<b>19-166</b>	116 x 35 mm	0.30L
<b>19-167</b>	128 x 38 mm	0.40L
<b>19-168</b>	147 x 40 mm	0.50L
<b>19-169</b>	157 x 45 mm	0.75L
<b>19-170</b>	187 x 45 mm	1.00L



**19-171**  
Ø 110 x 28 mm 0.15L



**19-172**  
100 cc 0.1L



**19-173 - 176**  
**19-173** 0,25L  
**19-174** 0,50L  
**19-175** 1,00L  
**19-176** 2,00L



**19-177**  
235 x 190 x 40 mm



**19-178**  
Ø 220 x 70 mm



**Hospital Wares**



**19-179**  
∅ 50 x 100 mm  
Powder Pot



**19-180**  
∅ 50 x 75 mm  
Methot With Lid



**19-181**  
∅ 50 x 75 mm  
Methot Without Lid



**19-182**



**19-183**



**19-184**



**19-185 - 186**

**19-185** ∅ 235 mm  
**19-186** ∅ 310 mm

## Needle Cases



**19-187**  
Sauerbruch  
210 x 125 x 17 mm



**19-188**  
Sauerbruch  
210 x 125 x 17 mm



**19-189**  
150 x 95 x 13 mm



**19-190**  
150 x 95 x 13 mm



**19-191**  
150 x 95 x 13 mm



**19-192**  
150 x 95 x 13 mm



**19-193**  
150 x 95 x 13 mm



**19-194**  
150 x 95 x 13 mm



**19-195**  
150 x 95 x 11 mm

## Storing Cases



19-199 - 209

19-199	230 x 130 x 50	mm
19-200	260 x 150 x 50	mm
19-201	275 x 235 x 50	mm
19-202	300 x 200 x 50	mm
19-203	325 x 275 x 50	mm
19-204	420 x 175 x 50	mm
19-205	230 x 130 x 75	mm
19-206	260 x 150 x 75	mm
19-207	300 x 200 x 75	mm
19-208	325 x 275 x 75	mm
19-209	420 x 175 x 75	mm



**19-196**  
Deponette  
245 x 135 x 35mm



**19-197**  
Deponette  
245 x 135 x 50mm



**19-198**  
Deponette  
245 x 135 x 60mm



## Sterilizing Baskets / Trays



19-210 - 212

19-210	480 x 250 x 50	mm
19-211	520 x 250 x 75	mm
19-212	520 x 250 x 100	mm



19-219  
(60 x 30 x 15 cm)  
Nominal dimensions



19-213 - 218

19-213	240 x 240 x 50	mm
19-214	240 x 240 x 80	mm
19-215	240 x 240 x 100	mm
19-216	480 x 260 x 50	mm
19-217	520 x 260 x 80	mm
19-218	520 x 260 x 100	mm

## Scissors with Tungsten Carbide Inserts

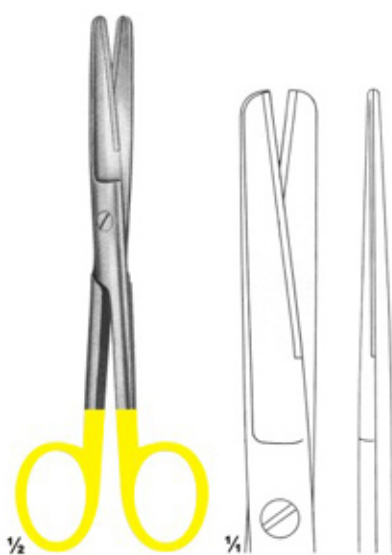

**26-101**  
Standard

14,5cm  
16,5cm  
18,5cm

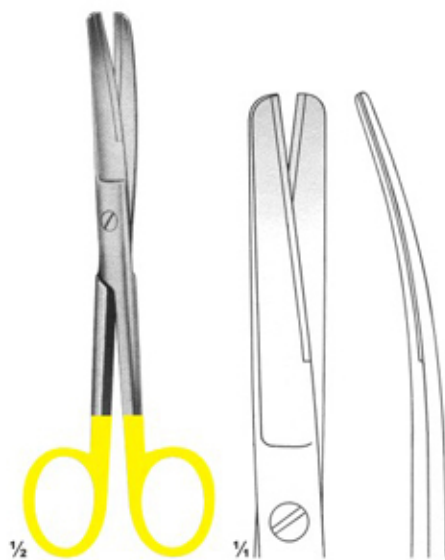

**26-102**  
Standard

14,5cm  
16,5cm  
18,5cm

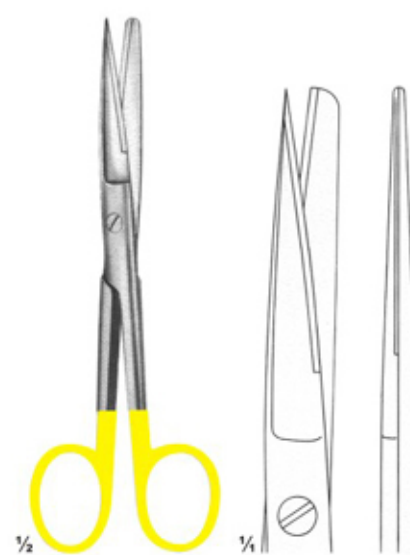

**26-103**  
Standard

14,5cm  
16,5cm  
18,5cm

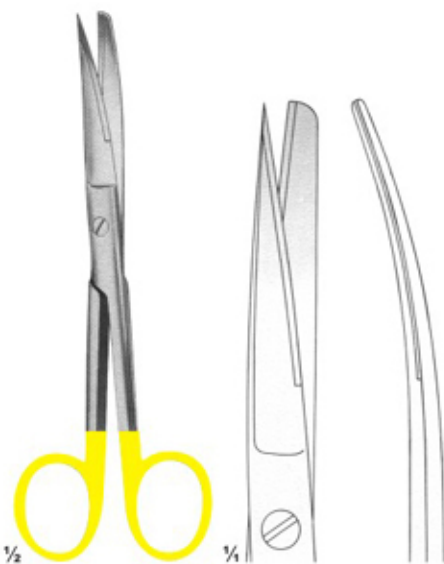

**26-104**  
Standard

14,5cm  
16,5cm  
18,5cm

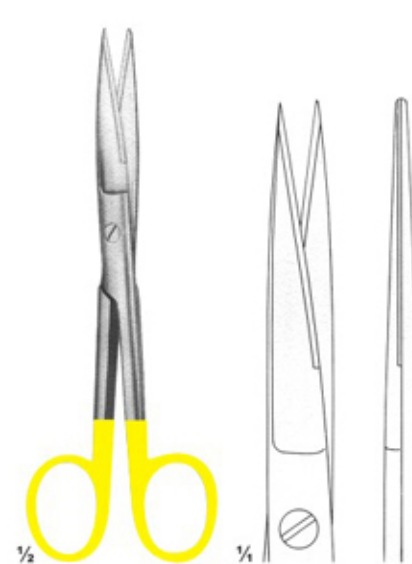

**26-105**  
Standard

14,5cm  
16,5cm  
18,5cm



**26-106**  
Standard

14,5cm  
16,5cm  
18,5cm



## Scissors with Tungsten Carbide Inserts

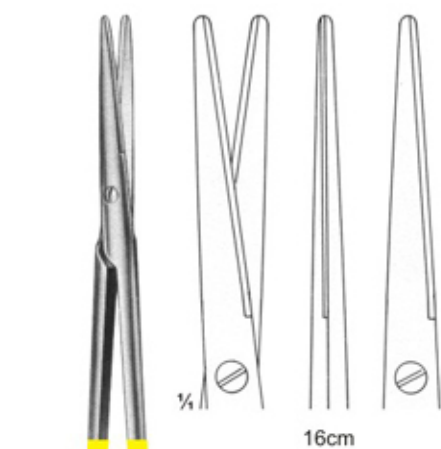

1/2  
**26-107**  
Mayo-Lexer

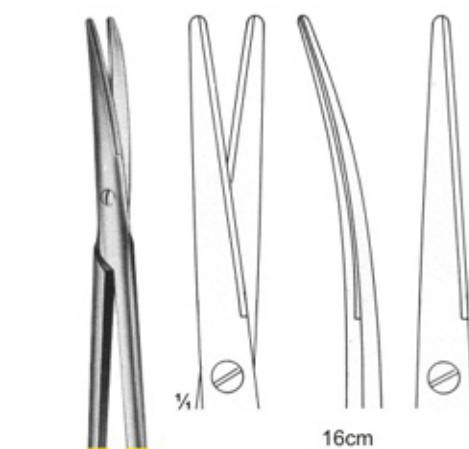

1/2  
**26-108**  
Mayo-Lexer

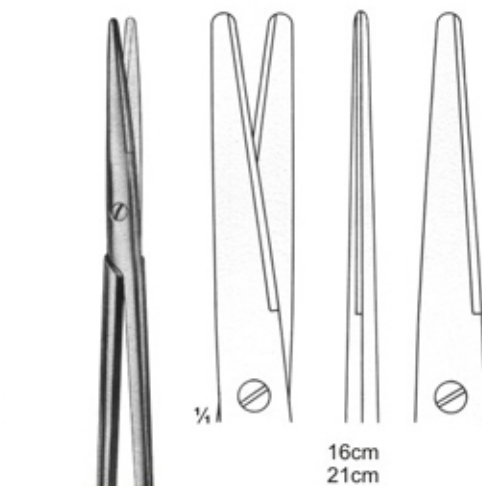

1/2  
**26-109**  
Lexer

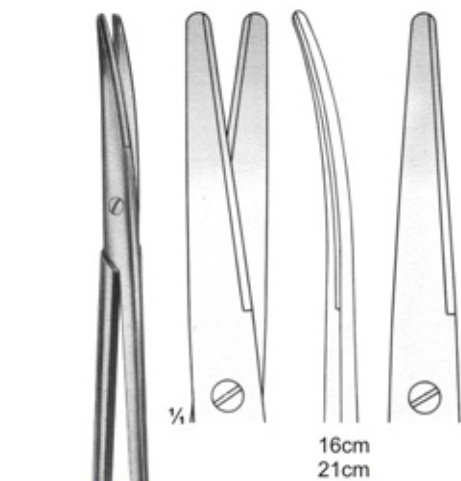

1/2  
**26-110**  
Lexer

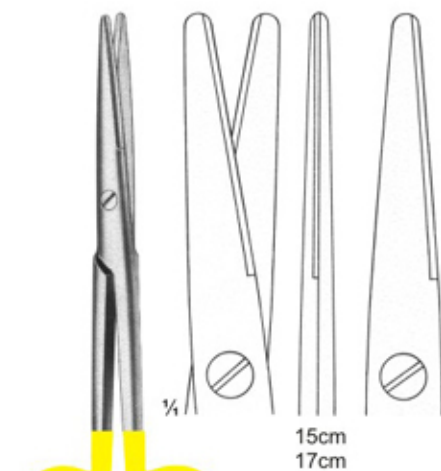

1/2  
**26-111**  
Mayo-Stille

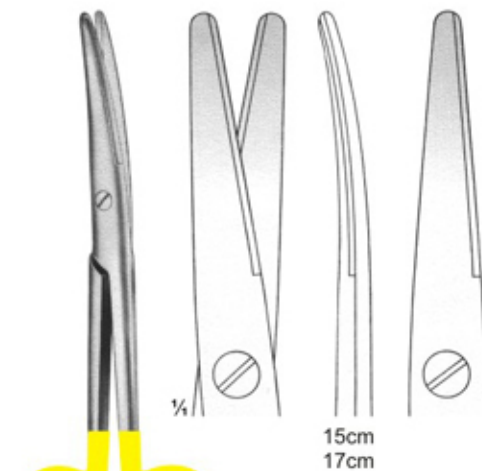

1/2  
**26-112**  
Mayo-Stille

## Scissors with Tungsten Carbide Inserts



**26-113**  
Metzenbaum

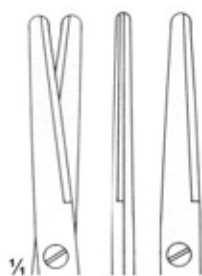

18cm  
20cm  
28cm  
30cm

11,5cm  
14,5cm  
23,5cm  
25,5cm



**26-114**  
Metzenbaum



11,5cm  
23cm

14,5cm  
25cm



**26-115**  
Metzenbaum



18cm  
28cm

20cm  
30cm

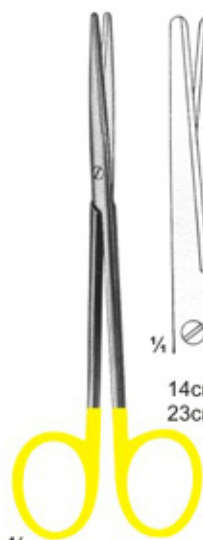

**26-116**  
Metzenbaum-Fino

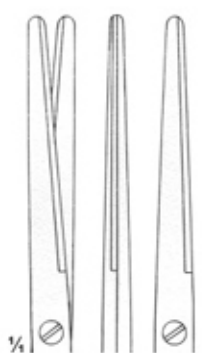

14cm  
23cm

18cm  
25cm

20cm  
28cm

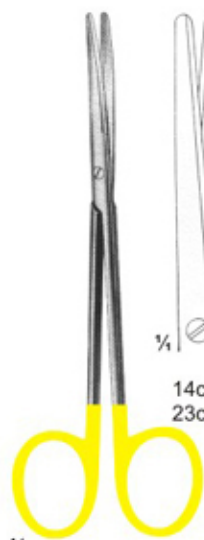

**26-117**  
Metzenbaum-Fino

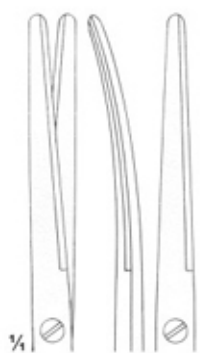

14cm  
23cm

18cm  
25cm

20cm  
28cm

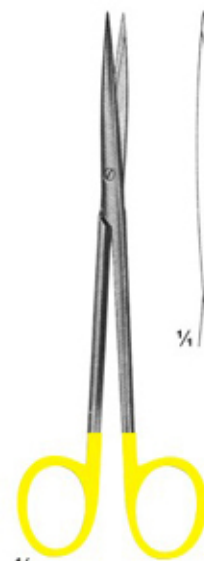

**26-118**  
Metzenbaum-Fino



14cm  
20cm

18cm  
23cm

## Scissors with Tungsten Carbide Inserts

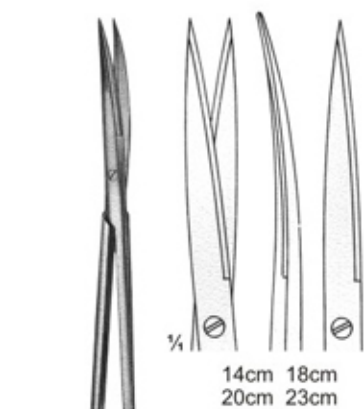

$\frac{1}{2}$   
**26-119**  
Metzenbaum-Fino

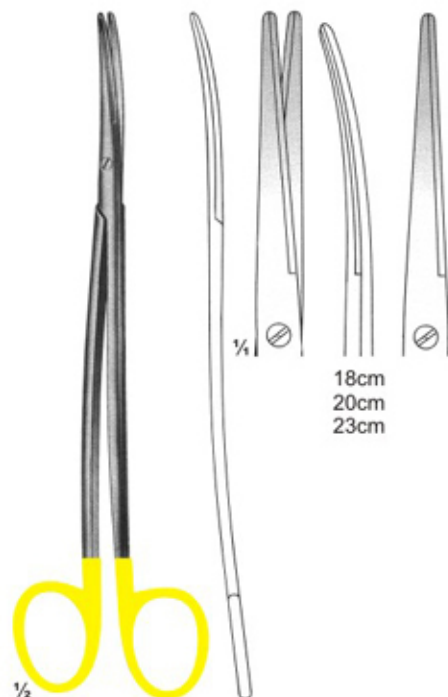

$\frac{1}{2}$   
**26-120**  
Metzenbaum-Fino

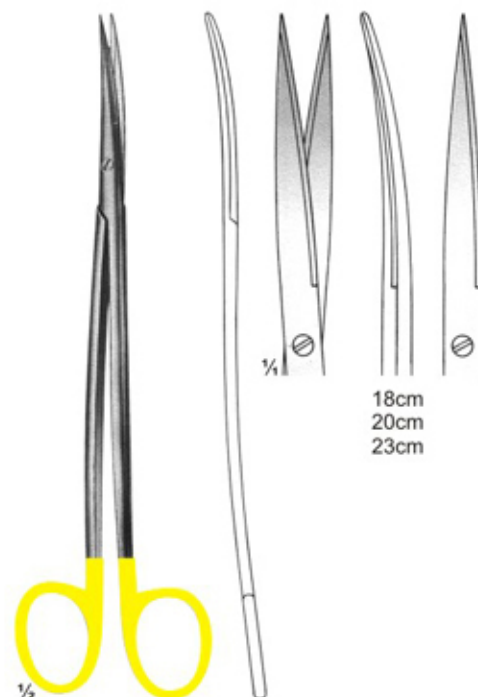

$\frac{1}{2}$   
**26-121**  
Metzenbaum-Fino

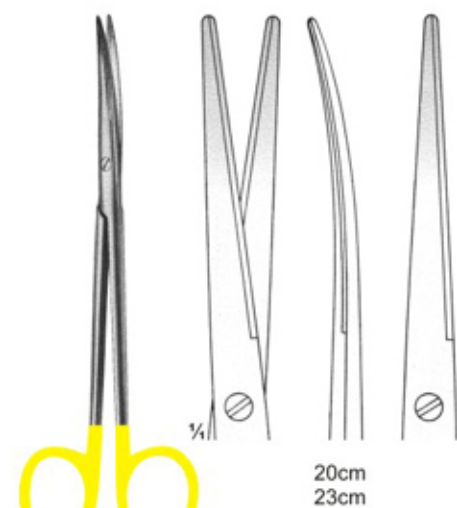

$\frac{1}{2}$   
**26-122**  
Metzenbaum

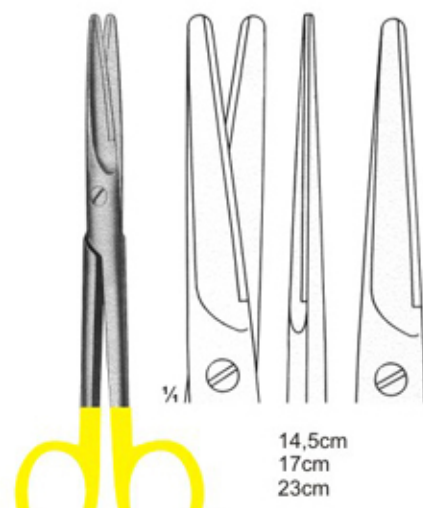

$\frac{1}{2}$   
**26-123**  
Mayo

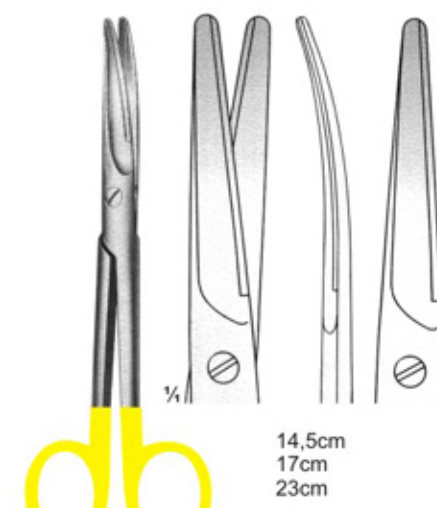

$\frac{1}{2}$   
**26-124**  
Mayo

**Scissors with Tungsten Carbide Inserts**

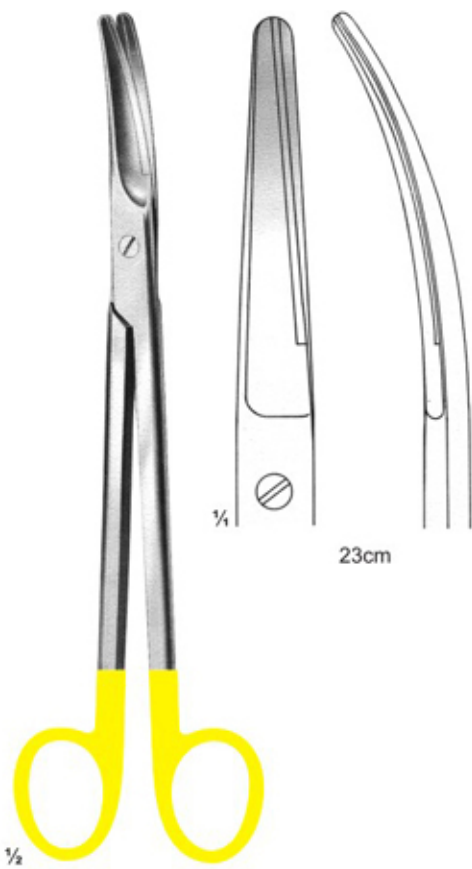

**26-125**  
Parametrium

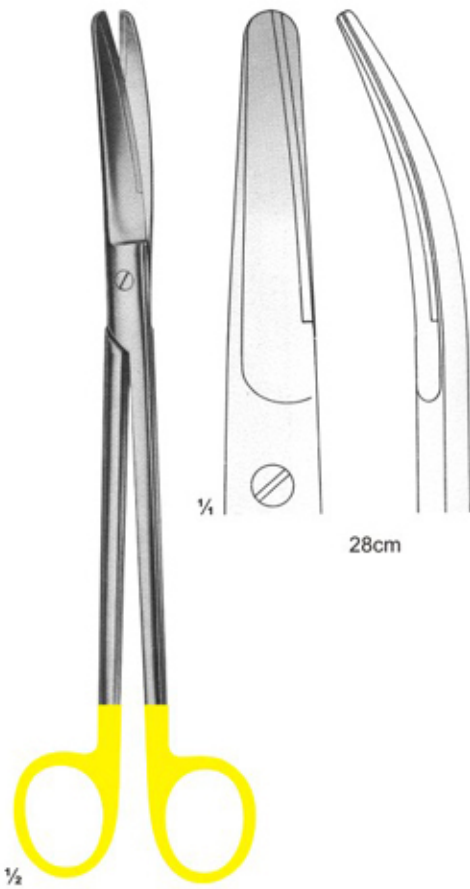

**26-126**  
Mayo-Harrington

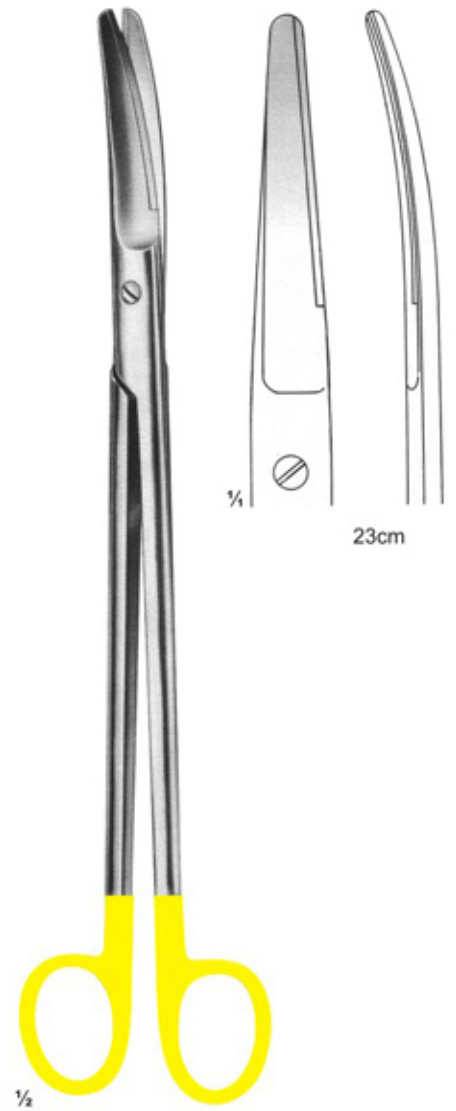

**26-127**  
Sims





**Benodict**  
SURGICAL INSTRUMENTS

## Scissors with Tungsten Carbide Inserts

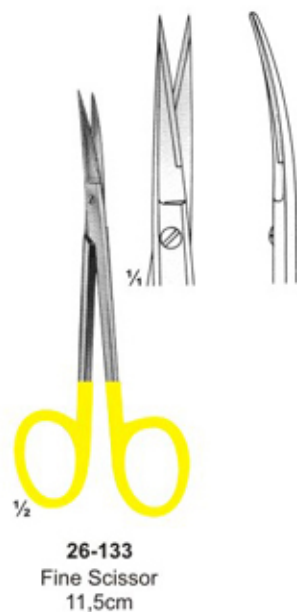
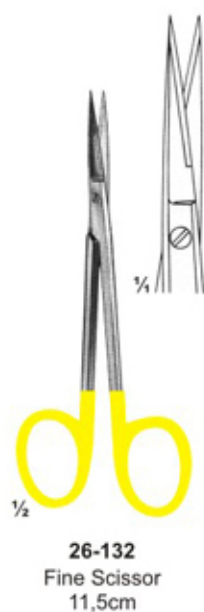
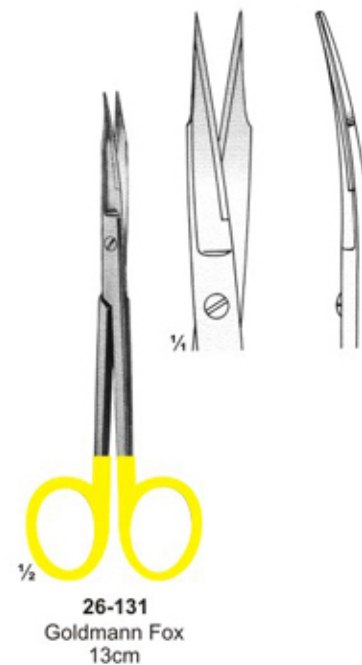
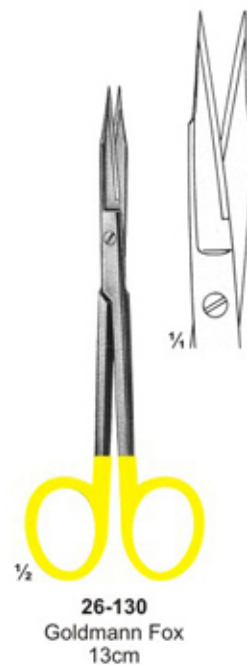
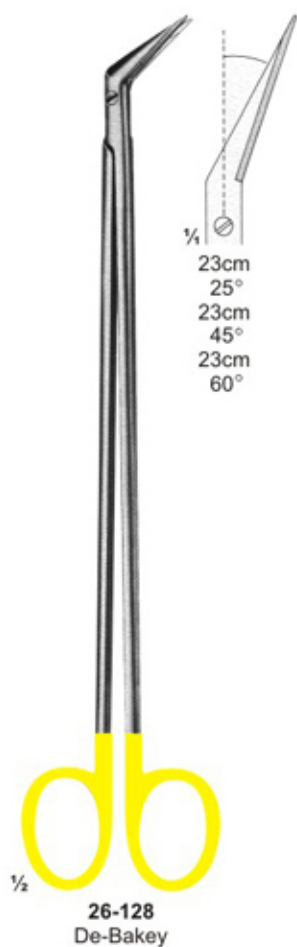



**Scissors & Dissecting Forceps with  
Tungsten Carbide Inserts**

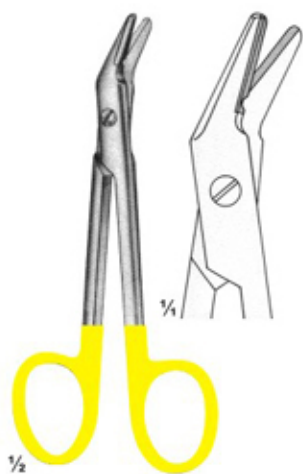

**26-136**  
Universal  
12cm

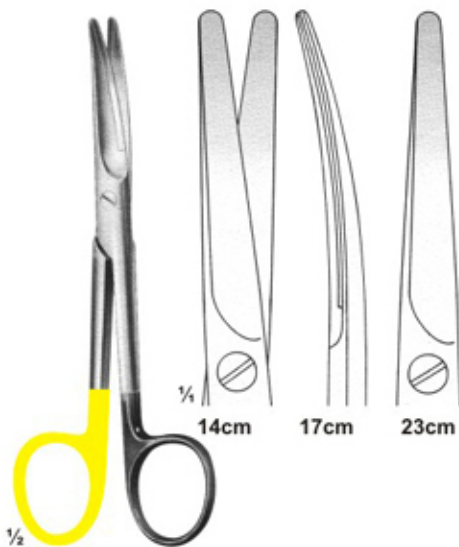

**26-137**  
Ligature Scissors  
1 Black & 1 Goldplated ring

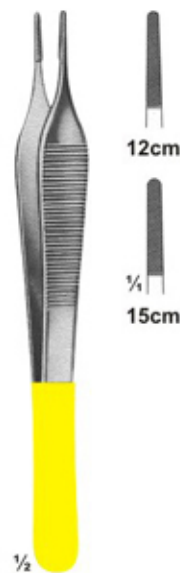

**26-138**  
Adson



**26-139**  
Cushing  
17,5cm



**26-140**  
Cushing  
18cm



**26-141**  
Cushing-Taylor  
18cm



**26-142**  
Dissecting Forceps  
15cm



**26-143**  
Semken  
15cm

# Dissecting Forceps and Needle holders with

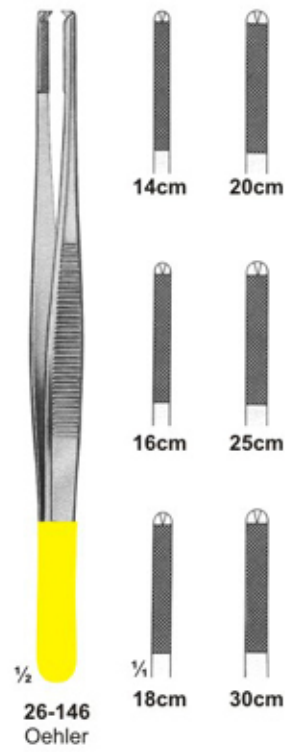
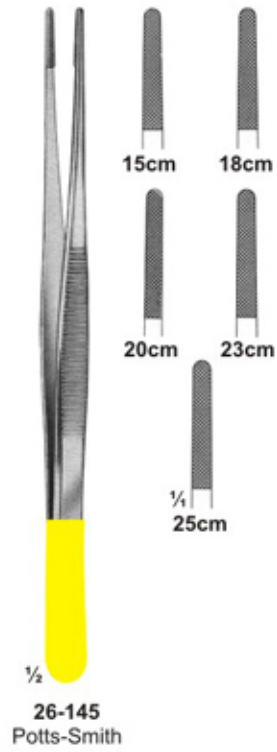
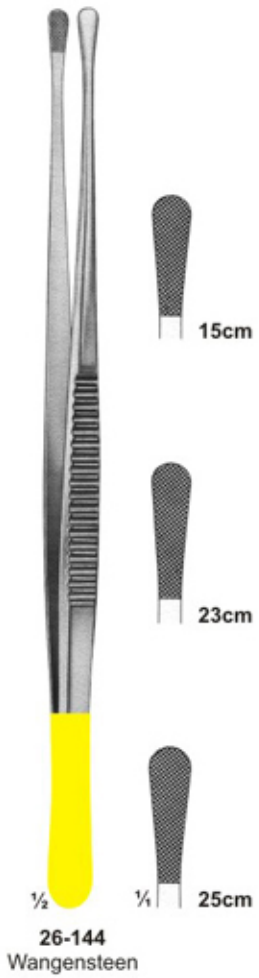



# Needle holders with Tungsten Carbide Inserts



**26-152**  
Arruga  
16cm



**26-153**  
Castroviejo  
13cm

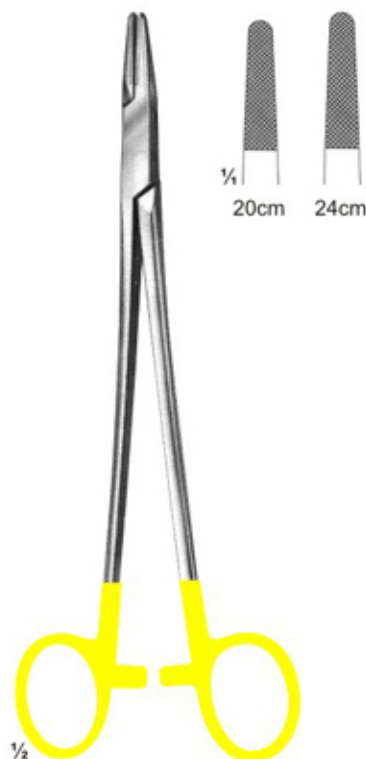

**26-154**  
Hegar  
20cm 24cm

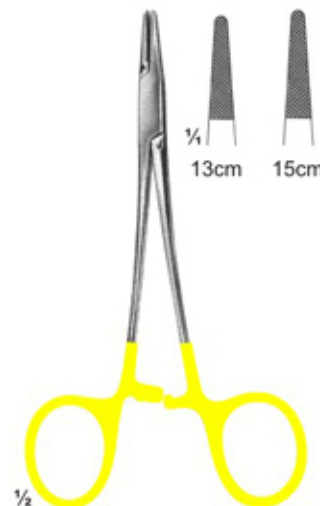

**26-155**  
Halsey  
13cm 15cm



**26-156**  
Mayo-Hegar  
16cm 18cm 20cm  
24cm 26cm 30cm

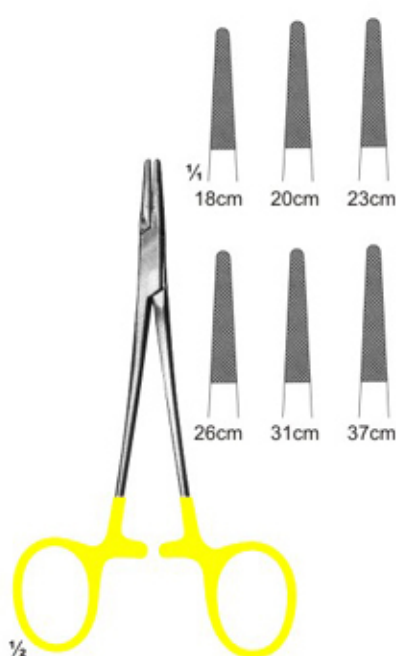

**26-157**  
De-Bakey  
18cm 20cm 23cm  
26cm 31cm 37cm

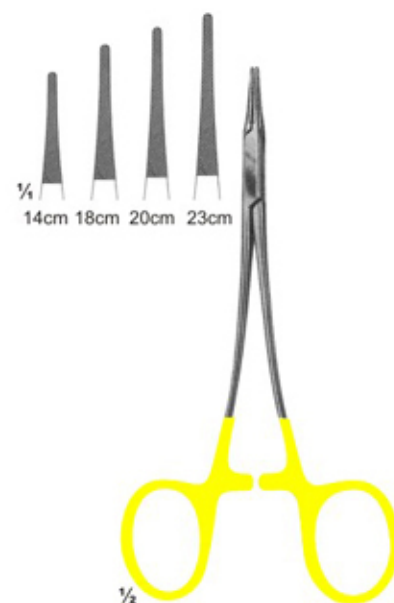

**26-158**  
Hegar-Vascular  
14cm 18cm  
20cm 23cm



# Needle holders with Tungsten Carbide Inserts

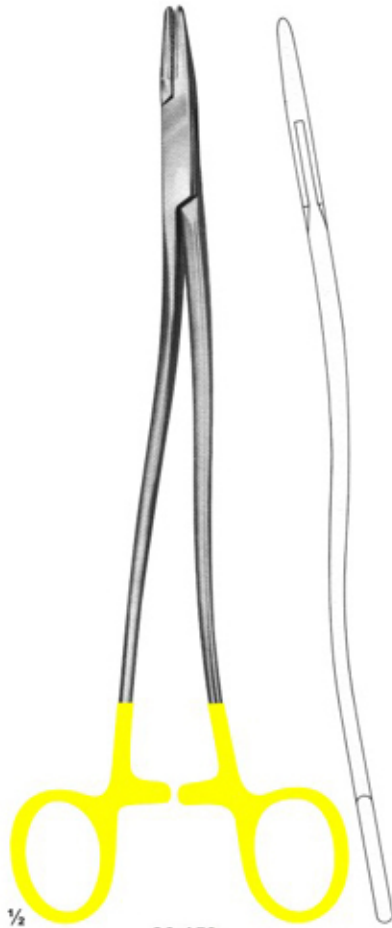

$\frac{1}{2}$   
**26-159**  
Bozemann-Wertheim  
20cm 24cm 26cm



$\frac{1}{2}$   
**26-160**  
Stratte  
22cm 23cm

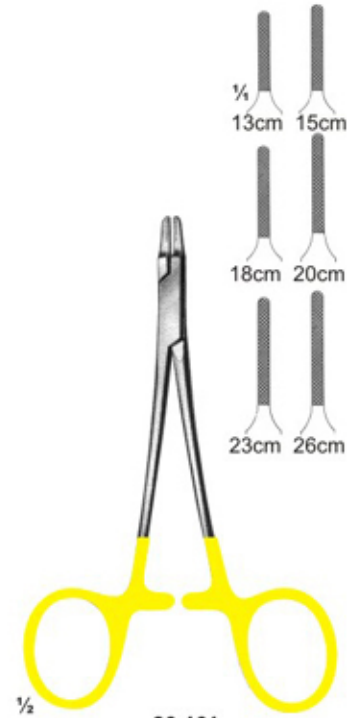

$\frac{1}{2}$   
**26-161**  
Ryder  
13cm 15cm 18cm  
20cm 23cm 26cm



$\frac{1}{2}$   
**26-162**  
Ryder-Vascular  
13cm 15cm 18cm  
20cm 23cm 26cm



$\frac{1}{2}$   
**26-163**  
Martin  
15cm 17cm 20cm

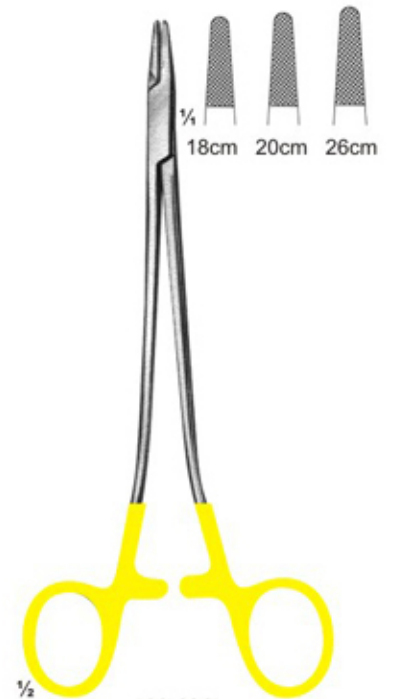

$\frac{1}{2}$   
**26-164**  
Sarot  
18cm 20cm 26cm



## Needle holders with Tungsten Carbide Inserts

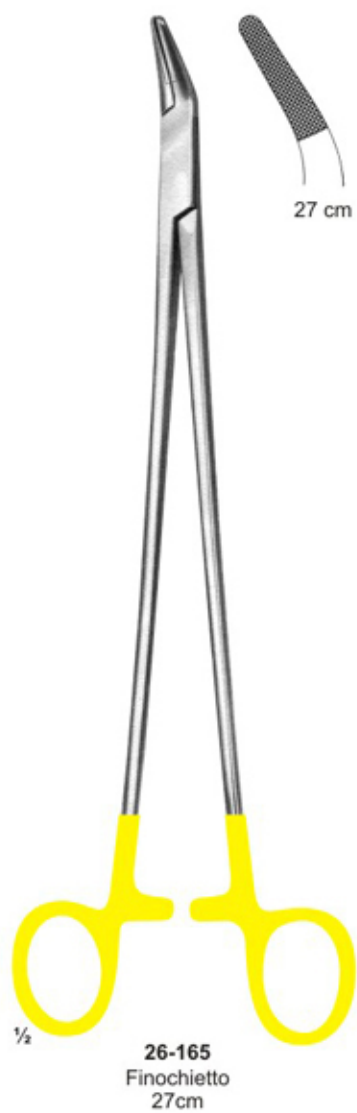

**26-165**  
Finochietto  
27cm



**26-166**  
Heaney  
20cm 24cm

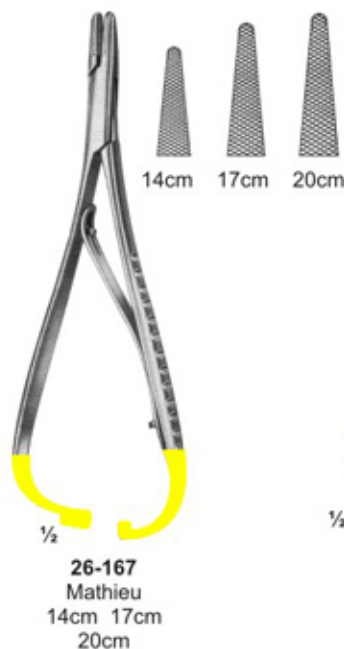

**26-167**  
Mathieu  
14cm 17cm  
20cm



**26-168**  
Mathieu  
12cm  
20cm 23cm



**26-169**  
Mathieu-Kosher  
14cm 17cm  
20cm 24cm



**26-170**  
Mathieu-Kosher  
17cm  
20cm 24cm



**26-171**  
Mathieu-Vascular  
17cm  
20cm 24cm





## Needle holders with Tungsten Carbide Inserts



26-172  
Mathieu-Ryder  
17cm  
20cm 24cm



26-173  
Lichtenberg  
20cm



26-174  
Langhals  
20cm 25cm



26-175  
Lichtenberg  
20cm 25cm



26-176  
Luehty-Beck  
20cm 25cm



26-177  
Luehty-Beck  
20cm 25cm



26-178  
Langebeck  
18cm  
20cm 23cm



26-179  
Langebeck-beck  
18cm  
20cm 23cm

**Wire Cutting Plier With T.C. Inserts**



**26-180**  
**TOENNIS**  
Elastic pattern for  
dura-or intestinal suture  
180 mm



**26-181**  
**Cutting Plier**  
12 cm

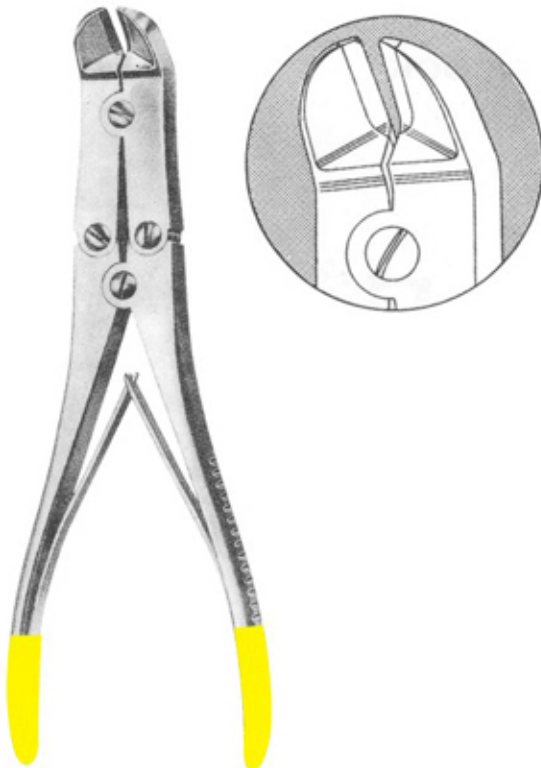

**26-182**  
**MULLAR CLAUS**  
22 cm

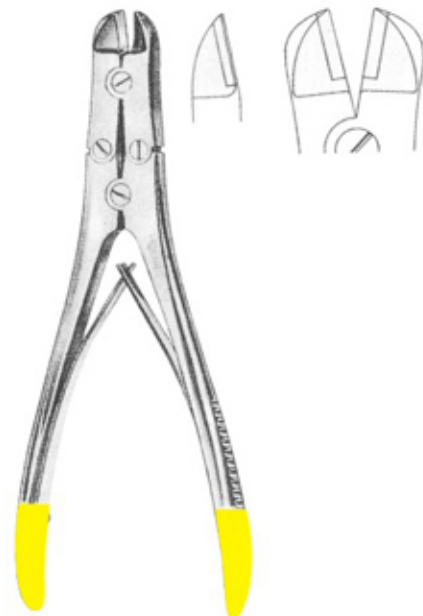

**26-183**  
**Plier**  
17.5 cm



## Alphabetical Index

<b>A</b>	
ABRAHAM, tonsil knife	13
ADSON, forceps	33
ADSON, forceps	37
ALLIS, artery traction forceps	47
ALLIS, intestinal grasping forceps	86
ALY, aesthesiometer	01
AMPUTATING KNIVES	12
ANDREW, tongue depressor	04
ANESTOPHON, stethoscope	02
ARRUGA, forceps	37
ARRUGA, needle holder	61
ASCH, biopsy curettes	112
AUFRIEHT, rasps	138
AYRE, cone knife, 235mm	13
ADSON - BROWN, Tissue Forceps	39
ADSON, Haemostatic Forceps	52
ANGLE, Wire Cutters Cutting Scissors	151
<b>B</b>	
BABCOCK, intestinal grasping forceps	86
BABY-ALLIS, artery traction forceps	47
BACKHAUS, towel clamps	48
BACKHAUS-KOCHER, towel clamps	48
BAILEY, rib spreaders	128
BAKES, gall duct dilators	95
BALFOUR, abdominal retractors	85
BALFOUR-BABY, abdominal retractors	84
BANE-HARTMANN, bone rongeurs	144
BARTH, bone curettes	139
BABY-MOSQUITO, Haemostatic Forceps	51
BABY-ROUX, Retractors	73
BABY-SENN-MILLER, Retractors	73
BEEBE wire scissor	29
BEER, cilia forceps	42
BENGOLEA, delicate forceps	50
BERGER, biopsy forceps	115
BERLINER, percussion hammer	01
BENDING PLIERS, Wire Holding forceps	150
BERTILLON, Examination & Measuring Instruments	10
BIEMER, vein scissor	16
BISHOP-HARMON, forceps	37
BIEMER, Suction Instruments	158
BLAKE, gall stone forceps	96
BLUMENTHAL, bone rongeurs	144
BONNEY, tissue forceps	41
BOSE, tracheal hooks	119
BOWLES, stethoscope	02
BOYS-ALLIS, artery traction forceps	47
BOZEMANN, dressing forceps	108
BOYNTON, Needle Holders	47
BRAUN, artery traction forceps	107
BRAUN, uterine probes	28
BRAUN-STADLER episiotomy scissor	31
BRAUN-STADLER, bandage scissors	102
BRIESKY, vaginal specula	66
BRODIE, probes	34
BROPHY, dissecting forceps	04
BRUENINGS, tongue depressor	13
BRUNINGS, tonsil knife, 215mm	76
BRUNNER, retractors	126
BRUNNER, rib shears	31
BRUNS, plaster scissor	64
BRYANT, sponge forceps	43
BROPHY, Tissue Forceps	38
BROWN, Tissue Forceps	39
BUCHS, retractors	75
BUCHWALD, tongue depressor	04
BUCK, neurological hammer	01
BUMM, ovum forceps	230
BUCK, Ear Curettes	110
<b>C</b>	
CASPAR, retractor	75
CASPAR, Micro scissor 115mm	16
CASTROVIEJO, tissue forceps	37
CASTROVIEJO, micro spring scissor	15
CASTROVIEJO, needle holder	61
CASTROVIEJO, eye scissor 110mm	15
CASTROVIEJO, eye scissor 115mm	15
CATLIN, amputating knife 160mm	12
CALIPER, Examination & Measuring Instruments	10
CARREL, Haemostatic Forceps	51
CARROLL, Examination & Measuring Instruments	10
CASPAR, Rongeurs	133
CASPAR, Rongeurs	134
CASTROVIEJO, Examination & Measuring Instruments	10
CHAPUT, artery traction forceps	47
CLOWARD, lamina Spreaders	83
CLAUS PLIER, Wire Cutting Plier With T.C. Inserts	187
CLAUS PLIER, Wire Cutting Plier With T.C. Inserts	187
COAKLEY, antrum trocars	100
COLLIN, intestinal grasping forceps	86
COLLIN, rib shears	126
COLLIN, sponge and dressing forceps	44
COLLIN, tongue forceps	05
COLLIN, vaginal spatula	101
CONE KNIFE 235mm11	13
CONVERSE, fine wound retractor	69
COOLEY, multi purpose clamps	122
COTTLE, retractors	71
COTTLE, nasal scissor	25
COTTLE, fine wound retractor	69
COTTLE, mallets	140
COLLIN, Examination & Measuring Instruments	10
COLLIN, Intestinal Grasping Forceps	46
COLLIN, Retractors	73
COLLIN-HARTMANN, Retractors	73
COTTLE, Forceps, Bayonet - Shaped	40
COTTLE, Nasal Specula	91
CRILE, Haemostatic Forceps	52
CRILE, Haemostatic Forceps	52
CRILE, Retractors	73
CUTTING PLIER, Wire Cutting Plier With T.C. Inserts	187
CRAFOORD, haemostatic forceps	50
CRILE, needle holder	63
CUSCO, vaginal specula	101
CUSHING, wound and vein retractor	71
CUSHING, dissecting forceps	34
CUSHING-KOCHER, retractors	71
CZERNY, gall stone forceps	96
CZERNY, retractors	72





## Alphabetical Index

<b>D</b>		<b>F</b>	
DAVIDSON, scapula retractors	77	FARABEUF, Retractors	73
DAVIS, vascular spatulas	120	FEILCHENELD, splinter forceps	42
DANDY, Haemostatic Forceps	51	FERGUSSON, haemorrhoidal forceps	93
DE BAKEY, forceps	36	FERGUSSON, suction instrument	163
DE BAKEY, anastomosis clamps	89	FERGUSSON-ACKLAND, mouth gag	05
DE BAKEY, anastomosis clamps	125	FINOCHIETTO, forceps	58
DE BAKEY, arteriotomy scissor	22	FINOCHIETTO, rib spreader	127
DE BAKEY, vana cava clamps	123	FINSEN, tracheal hooks	119
DE BAKEY, multi purpose clamps	122	FIBER OPTIC, laryngoscopes	09
DE BAKEY, retractors	82	FINGER NAIL DRIL, Finger Nail Instruments	155
DE BAKEY, atraumata	121	FINGER RING SAW, Finger Nail Instruments	155
DEAN, nasal and tonsil scissor	25	FINSTERER, Suction Instruments	161
DEAVER, retractors	77	FLAT-NOSED PLIERS, Wire Holding forceps	150
DEAVER, surgical scissor (flat lock)	21	FOERSTER-BALLENGER, Tissue Grasping Forceps	45
DE-BAKEY, bulldog clamps	49	FORCEPS, Finger Nail Instruments	155
DEJERINE, percussion hammer	01	FOREGGER, laryngoscopes	09
DELICATE DISSECTING FORCEPS	33	FOMON, nasal scissor	19
DELICATE SCISSORS, blunt points	19	FORD-BOWLES, stethoscope	02
DELICATE SCISSORS, sharp points	18	FOWLER, tonsil knife	13
DELICATE SCISSORS, sharp points	19	FRANCKE, blood lancet	06
DENHARDT, mouth gag	05	FRAZIER, fine wound retractor	69
DENIS-BROWENE, intestinal forceps	41	FRAZIER, suction instruments	163
DERRA, multi purpose clamps	122	FREER, fine wound retractor	69
DESCHAMPS, ligature needles	65	FREER, vascular spatulas	120
DESJARDINS, gall duct forceps	95	FRENZEL, tongue depressor	04
DESJARDINS, gall stone forceps	96	FRICKE, haemostatic forceps	56
DESJARDINS, gall stone scoops	95	FRITSCH, retractor	79
DESMARRES, wound and vein retractors	71		
DEMEL, Cerclage Instruments	148	<b>G</b>	
DIAGNOSTIC SETS	07	GALLAHER, rasp	126
DICK, vaginal clamps and compression forceps	59	GELPI, special retractors	82
DIEFFEBACH, bulldog clamps	49	GELPI, vaginal retractors	105
DINGMANN, bone holding forceps	142	GERALD, dissecting forceps	34
DISSECTING KNIVES	11	GIERTZ-STILLE, rib shears	126
Dissection Instruments	164	GILL, tissue forceps	37
Dissection Instruments	165	GILL-HESS, tissue forceps	37
Dissection Instruments	166	GILLIES, fine wound retractor	69
DITTEL, metal bougies	80	GILLIES, needle holder	63
DOYEN, abdominal retractors	79	GLOVER, bulldog clamp	49
DOYEN, intestinal clamps	87	GLUCK, rib shears	126
DOYEN, ovum forceps	230	GOOD, tonsil scissors	25
DOYEN, probes	66	GORNEY, suction instruments	163
DOYEN, towel clamps	48	GOSSET, abdominal retractors	84
DOYEN, vaginal specula	104	GRAEFE, fine wound retractor	69
DUROGRIP, Wire Holding forceps	149	GRAVE, vaginal specula	102
DUROTIP, Cutting Pliers	152	GROSS, dressing forceps	43
DUROTIP, Cutting Pliers	153	GUEDEL-NEGUS, laryngoscope	08
DUROTIP, Wire Cutters Cutting Scissors	151	GUTHRIE, fine wound retractor	69
DUVAL-COLLIN, Intestinal Grasping Forceps	46	GUYON, kidney clamps	97
DUPLAY, sponge and dressing forceps	43	GERALD, Tissue Forceps	38
DUVAL, intestinal forceps	41	GILLIES, Tissue Forceps	38
		GOLDSMITH, Nasal Specula	91
<b>E</b>		GRAEFE, Tissue Forceps	39
EISELSBERD, needle holder	63	GRAEFE, Tissue Forceps	39
ELSCHING, forceps	37	GRUENWALD, Forceps, Bayonet - Shaped	40
ENGL.MOD, towel clamps	48		
EPPENDORF, biopsy forceps	115	<b>H</b>	
ESMARCH, cloth and plaster scissors	31	HALLE, vascular spatulas	120
EISELSBERG-MATHIEU, Needle Holders	64	HALSTED-MOSQUITO, haemostatic forceps	50
EXTRACTION PLIERS, Wire Holding forceps	150	HARTMANN, intestinal clamps	87



## Alphabetical Index

HARVEY, plate scissors	29	KELLY, tissue grasping forceps	44
HAJEK-KOFLER, Punches	130	KERN-LANE, bone holding forceps	143
HALSTED, Haemostatic Forceps	52	KERRISON-JACOBY, punches	129
HALSTED-MOSQUITO, Haemostatic Forceps	51	KERSTING, anastomosis forceps	89
HARTMANN, Ear Polypus Forceps	112	KELLY, Haemostatic Forceps	51
HARTMANN-HALLE, Nasal Specula	91	KERRISON, Punches	130
HARTMANN-HERZFELR, Ear Polypus Forceps	112	KILLIAN, bone shear	26
HARTMANN-HOFFMAR, Ear Polypus Forceps	112	KILLIAN, rectal spatula	90
HARTMANN-WULLSTEIN, Ear Polypus Forceps	112	KILNER, fine dissecting scissors	22
HARVEY, Wire Cutters Cutting Scissors	151	KILNER, fine wound retractor	69
HEANEY, needle holder	62	KILNER, dissecting scissor	22
HEGAR, needle holder	62	KILLIAN, Nasal Specula	90
HEGAR-OLSEN, needle holder	63	KIRSCHNER, Cutting Pliers	154
HEGER, uterine dilators	106	KIRSCHNER, Wire Extension	147
HEISS, haemostatic forceps	50	KOCHER, Haemostatic Forceps	52
HEISS, dressing forceps	58	KOCHER, Haemostatic Forceps	54
HEISTER, mouth gag	05	KOCHER-OCHSNER, Haemostatic Forceps	55
HENING, plaster spreader	157	KLIMA ROSEGGER, trocars	100
HERGET, biopsy forceps	113	KOCHER, retractor	71
HERTZLER, abdominal retractors	84	KOCHER, bladder retractors	99
HERTZLER, rib spreaders	127	KOCHER, bone retractor	74
HESS, tissue forceps	37	KOCHER, retractors	75
HEYMANN-KNIGHT, scissors	25	KOLLE, blood lancet	06
HEYWOOD-SMITH, ovum forceps	109	KONIG, elevators	135
HEYWOOD-SMITH, sponge holding forceps	44	KONIG, raspatories	137
HEYWOOD-SMITH, tongue forceps	05	KONISATION SMESSER, retractors	57
HOLLOW NEEDLE, Suction Instruments	159	KRAUSE, biopsy tip	115
HOUSE, Suction Instruments	161	KRISTELLER, vaginal specula	102
HUBER, biopsy forceps	115	KRISTELLER, vaginal specula	103
HUNT, tumor & vessel forceps	32	KRONECKER, suture instruments	65
HUNTER, splinter forceps	42	KRONLEIN, haemostatic forceps	56
		KUMMEL, intestinal spatula	80
<b>I</b>		<b>L</b>	
INGE, lamina spreaders	83	LABORDE, tracheal dilators	119
INTEROSSEOUS, cartilage knife	12	LAHEY, artery traction forceps	47
IVES-FANSLER, anoscopies	92	LAHEY, gall duct forceps	94
<b>J</b>		LANE TRETOWAN, bone levers	136
JACKSON BURROWS, retractors	82	LANE, bone holding forceps	143
JACOBSON, bone curettes	139	LANE, bone levers	136
JACOBSON, needle holder	61	LANE, tissue forceps	41
JAEGAR, fine wound retractor	69	LANE, towel clamps	48
JAMESON, dissecting scissor	22	LANGE-HOHMANN, bone levers	136
JAMESON, needle holder	62	LANGENBACK, bone levers	135
JANSEN, bone curettes	139	LANGENBECK, with triangle handle	70
JANSEN, bone rongeurs	144	LANGENBECK, flap knife	12
JOHNS-HOPKING, bulldog clamps	49	LARYNGEAL MIRRORS	06
JOLL (FRIEDMAN), retractors	82	LAWRENCE, ligature forceps	58
JOLL, vaginal retractors	105	LANDOLT, Suction Instruments	160
JONES, towel clamps	48	LANDOLT, Suction Instruments	161
JOSEPH, bone file	138	LANGENBECK, Ear Curettes	110
JOSEPH, dura and skin retractor	69	LEBSCHKE, rib shears	126
JOSEPH, raspatories	137	LEGUEU, bladder retractors	99
JUDD-MASSON, bladder retractors	99	LEKSELL-STILLE, bone rongeurs	145
JANSEN, FORCEPS, Bayonet – Shaped	40	LERICHE, intestinal spatula	80
		LEWIS, bone file	138
<b>K</b>		LISTER, bandage scissor	30
KADER, intestinal spatula	80	LISTER, cloth scissor	30
KALT, needle holder	61	LISTER, sponge forceps	43
KELLY, ovum forceps	109	LISTON, bone cutting forceps	146
KELLY, anoscopies	92		





## Alphabetical Index

LOCKHART-MUMMERY, probes	66	MULLER, dura and skin retractor	69
LOCKWOOD, Intestinal Grasping Forceps	46	MURPHY, head band	03
LUCAE, FORCEPS, Bayonet – Shaped	40	MUSEUX, tissue grasping forceps	47
LUER, Retractors	73	<b>N</b>	
LOCKLIN, delicate scissor	25	NASAL SCISSORS	25
LOPEZ-REINKE, suction instruments	163	NAUJOKS wire scissors	29
LOWER, gall duct forceps	94	NAIL SPLITTING, Finger Nail Instruments	155
LOWMAN, bone clamps	143	NEEDLE HOLDER, for micro surgery	48
LOWMAN-GERSTER, bone clamps	143	NEGUS, tonsil forceps	57
LOWMAN-HOGLUND, bone clamps	143	NELATON, probes	66
LUCAS, gouges	141	NELSON, lung dissecting forceps	41
LUER-KORTE, gall stone scoops	80	NISSEN, gall duct forceps	94
LURE, bone rongeurs	144	NOTO, ovum forceps	109
<b>M</b>		NOTO, sponge holding forceps	44
MAGILL, laryngoscope	07	NOVAK-SCHOECKAERT, biopsy curettes	111
MALTZ, rasps	138	NOYES, micro spring scissor	15
MANNERFELT, osteotomes	141	<b>O</b>	
MANNERFELT, retractors	70	OLIVECRONA, dura scissors	24
MARTIN, uterine probes	107	OLIVECRONA, trigeminal knife	13
MARTINI, bone curettes	139	OTOSCOPE SETS	07
MASING, retractors	71	OTOSCOPE, Diagnostic Sets	07
MASSON, needle holder	62	<b>P</b>	
MASSON-LUETHY, needle holder	62	PARTSCH, raspatories	137
MATHIEU, retractors	72	PARTSCH, gouges	141
MAYO, dissecting scissors	23	PARTSCH, raspatories	137
MAYO, uterine probes	107	PAYR, pylorus clamps	86
MAYO-HARRINGTON, dissecting scissors	23	PEAN, haemostatic forceps	57
MAYO-NOBLE, dissecting scissors	23	PEAN, haemostatic forceps	51
MAYO-STILLE, dissecting scissors	23	PEAN, kidney clamps	97
MARTIN, Nasal Specula	90	PEDERSON, vaginal specula	102
MATHIEU, Needle Holders	64	PEET, splinter forceps	42
MATHIEU-STILLE, Needle Holders	64	PELKMANN, uterine dressing forceps	108
MC INDOE, forceps	34	PERKINS, self retaining retractors	81
MC KENTY, raspatories	137	PIERCE, trocars	100
MEAD, mallets	140	PINARD, wooden stethoscope	02
MC INDOE, Tissue Forceps	38	PLESTER, retractors	81
MCINTOSH, laryngoscopes	09	PLESTER, suction instruments	163
MEDIUM, Dissecting Forceps	35	POOL, suction instruments	162
MICRO-HALSTED, Haemostatic Forceps	51	POTTS-SMITH, cardiovascular scissor	24
MILLIN, Needle Holders	64	PROBES	67
MICHEL, laryngeal mirrors	06	PARKER, Retractors	73
MICRO SCISSORS, laterally angled	17	PEAN, Haemostatic Forceps	52
MICRO-ADSON, forceps	33	PEAN, Haemostatic Forceps	53
MICRO-ADSON, forceps	37	PEAN, Haemostatic Forceps	54
MIDDELDORPF, retractors	75	PENNINGTON, Tissue Grasping Forceps	45
MIKULICZ, tissue forceps	57	PROVIDENCE-HOSPITAL, Haemostatic Forceps	51
MIKULICZ, intestinal spatula	80	<b>Q</b>	
MIKULICZ, retractors	78	QUERVAIN, bone levers	113
MILLER, laryngoscope	08	<b>R</b>	
MILLIN, bladder retractors	99	RABINER, neurological hammer	01
MIXTER, ligature forceps	58	RANDALL, biopsy curettes	111
MOD.USA, plaster spreader	127	RANDALL, kidney stone forceps	98
MORRIS, anastomosis clamps	89	RECAMIER, uterine scoops	116
MOYNIHAN, haemostatic forceps	57	REYNOLDS, dissecting scissors	22
MOYO-HEGAR, needle holder	62	RICHTER, vaginal retractors	105
MOD. WIEN, Nasal Specula	91	ROCHESTER-CARMALT, haemostatic forceps	57
MOLTGEN, Examination & Measuring Instruments	10	ROEDER, towel clamps	48
MULLAR, Wire Cutting Plier With T.C. Inserts	187		
MULLER LIGATURE FORCEPS	49		
MULLER VESSEL CLIPS	49		





## Alphabetical Index

### W

WANGENSTEEN, needle holder	62
WARTENMERG, pinwheel	01
WAGNER, Rongeurs	134
WAUGH, Tissue Forceps	38
WEBER, anastomosis clamps	124
WECKER, eye scissors	15
WEIL-BLAKESLEY, rongeurs	112
WEITLANER, self retaining retractors	81
WERTHEIM, gynaecology scissors	27
WERTHEIM, clamps and forceps	59
WERTHEIM-CULLEN, vaginal clamps	60
WIEDER, tongue depressor	04
WEIL-BLAKESLEY, Rongeurs	132
WILLIGER, bone curettes	139
WILLIGER, elevators	135
WILLIGER, raspatories	137
WINTER, ovum forceps	118
WILDE, Forceps, Bayonet – Shaped	40
WOLFF, plaster breakers	157
WULLSTEIN, retractors	81
WULLSTEIN, Suction Instruments	160

### Y

YASARGIL, needle holder	61
YASARGIL, tumor grasping forceps	32
YASARGIL-SAMII, tumor grasping forceps	32
YASARGIL, Suction Instruments	160
YASARGIL, Suction Instruments	161
YASRGIL, micro scissors	17
YEOMAN, biopsy forceps	113
YOUNG, tongue forceps	05
YOUNG– HRYNTSCHAK, Needle Holders	64
YOUNG-MILLIN, Needle Holders	64

### Z

ZENKER, ligature	58
ZENKER, retractors	77
ZIEGLER, head band	03
ZIEGLER, head mirror	03



Benedict John SBNS Surgical Instruments  
Aimna Abad Road, Gatto Rora, PO Ladhar,  
Sialkot - 51310, Pakistan.

Tel: +92-52-3525624

Cell: +92-344-4623925

Whats app: +92-344-4623925

Email: [bjsurgicalinstruments@gmail.com](mailto:bjsurgicalinstruments@gmail.com)

Email: [info@benodictsurgical.com](mailto:info@benodictsurgical.com)

Website: [www.benodictsurgical.com](http://www.benodictsurgical.com)